

Molteni & C

JULIAN — VINCENT VAN DUYSSEN 2026

1—
6



The Julian modular system stands out for its imposing presence and generously deep seating, conceived to offer comfort and adaptability to individual preferences through carefully calibrated cushions and lumbar supports. The cushioning is carefully designed to provide a soft, elastic seating experience while maintaining a clean and elegant aesthetic. The padding combines densities and dimensions engineered for balanced ergonomic support, while the distinctive piping unifies the aesthetic. The completeness of the modules - from terminal and central elements to islands and newly designed armrest-coffee tables - opens up endless compositional possibilities, allowing Julian to adapt naturally to any environment, interpreting space with balance and freedom. Julian pairs seamlessly with the Eter coffee table, also by Van Duysen, whose curved version allows for more enveloping and softly rounded compositions.



This symbol shows that the product has removable upholstery. Only qualified personnel can remove the upholstery of some of our products. If this information is pertinent, it will be included in the warnings section.



This symbol shows that the product is available on request in a fire resistant version that complies with the standards BS 5852 and TB 117-2013. The buyer is responsible for checking to make sure that the product is suitable and compliant with the requirements for the designated use and the current applicable laws and standards for the destination and use of the product.

DATASHEET

REGISTERED
DESIGN

2026

moltenigroup.com

Dimensions in centimeters and inches. The right to discontinue and make changes is reserved. This information is based on the latest product information available at the time of printing.

TECHNICAL INFORMATION

INTERNAL STRUCTURE

Frame made of solid spruce (Picea abies) and particle board panels, with elastic straps.

STRUCTURE PADDING

High-firmness, polyurethane foam. Cover in bonded velveteen.

BASE

Painted aluminium with non-slip plastic tips.

SEAT CUSHIONS

Insert in shaped polyurethane with variable density, cover in 100% cotton.

BACK CUSHIONS

Insert in polyurethane foam, recycled polyester fibre, 100% cotton cover.

LUMBAR CUSHIONS

100% cotton cover, polyester fibre.

TRINKET TRAY

Steel sheet covered in bonded hide leather in colours from the Molteni range.

STORAGE ARMREST

Medium-density wood fibreboard panel, glossy lacquered.

CORNER SMALL TABLE WITH GLOSSY LACQUERED STRUCTURE

Glossy lacquered medium-density wood fibreboard.

CORNER SMALL TABLE WITH GLOSSY TOP

Glossy lacquered medium-density wood fibreboard.

REMOVABLE OUTER COVER

(See attached card, specifically for the cover).



AVAILABLE IN FIRE-RESISTANT
VERSION TB117 AND BS5852

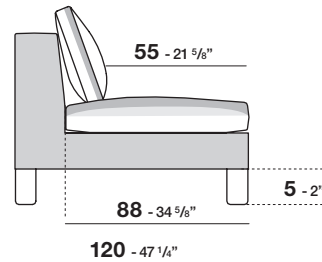
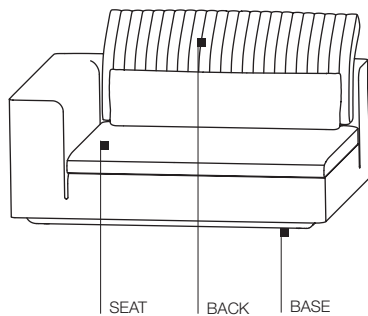

Seat depth for structure only, 88 cm
Seat depth with backrest cushion 55 cm
Feet height 5 cm (from ground to under seat)

NOTES

- ▶ **All modules are supplied with a quilted backrest cushion and a lumbar support cushion. All modules must be covered in the same material and colour.**
- ▶ **The structure and cushions are assembled with a profile according to the following rules:**
 - **fabric covers:**
grosgrain profile in the colours indicated in the finishes section.
 - **leather covers:**
profile in the same type of leather and in the colours in the collection.

FINISHES

GROSGRAIN FINISHES

anthracite
dark brown
olive green
paper white
beaver
saddle leather colour
iron
black
cream
sand
mouse grey

FINISHES

BONDED HIDE LEATHER FINISHES FOR TRINKET TRAY

ivory
dark brown
natural
mud green
dove grey
black
colonial
hazelnut

GLOSSY LACQUERED FINISHES SMALL TABLE / ARMREST

black
dolomite grey
pearl

DATASHEET

REGISTERED
DESIGN

2026

DIMENSIONS

end element

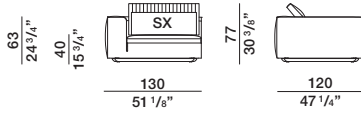

TE1312 dx-sx

end element

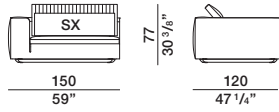

TE1512 dx-sx

end element

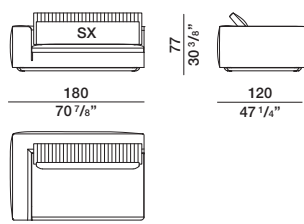

TE1812 dx-sx

end element / corner element

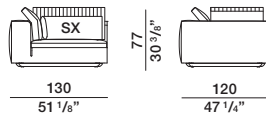

TA1312 dx-sx

end element / corner element

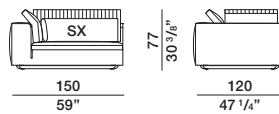

TA1512 dx-sx

back cushion

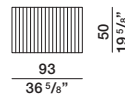

lumbar cushion

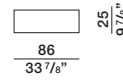

ornamental back cushion

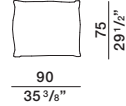

PCU90/75

back cushion

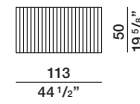

lumbar cushion

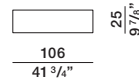

ornamental back cushion

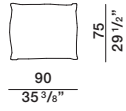

PCU90/75

back cushion

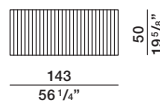

lumbar cushion

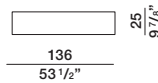

ornamental back cushion

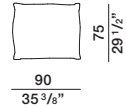

PCU90/75

back cushion A

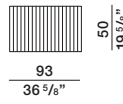

back cushion B

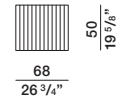

lumbar cushion C

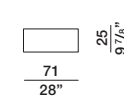

lumbar cushion D

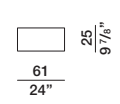

ornamental back cushion

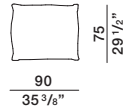

PCU90/75

back cushion A

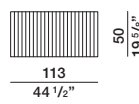

back cushion B

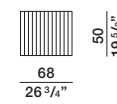

lumbar cushion C

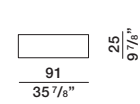

lumbar cushion D

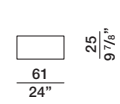

ornamental back cushion

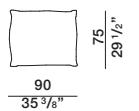

PCU90/75

Molteni & C

3
6

DATASHEET

REGISTERED
DESIGN

2026

moltenigroup.com

Dimensions in centimeters and inches. The right to discontinue and make changes is reserved. This information is based on the latest product information available at the time of printing.

DIMENSIONS

end element / corner element

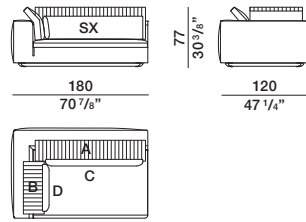

TA1812 dx-sx

back cushion A

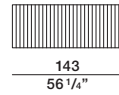

back cushion B

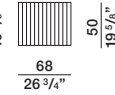

lumbar cushion C

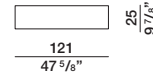

lumbar cushion D

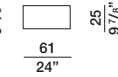

ornamental back cushion

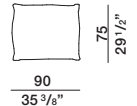

PCU90/75

central element

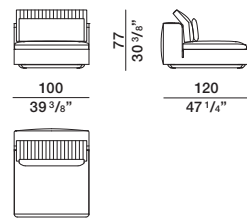

CE1012

back cushion

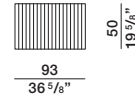

lumbar cushion

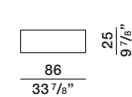

ornamental back cushion

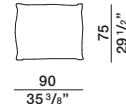

PCU90/75

central element for storage armrest

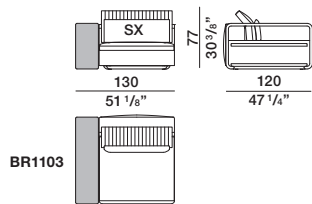

BR1103

CB1312 dx-sx

back cushion

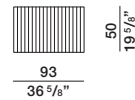

lumbar cushion

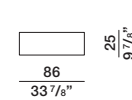

ornamental back cushion

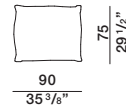

PCU90/75

storage armrest

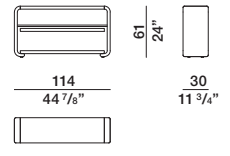

BR1103

central element

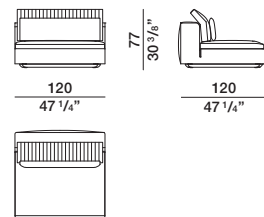

CE1212

back cushion

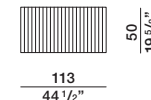

lumbar cushion

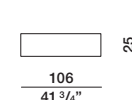

ornamental back cushion

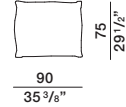

PCU90/75

central element for storage armrest

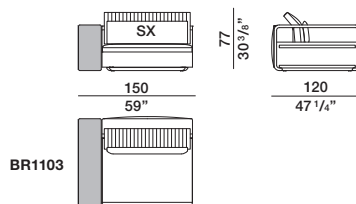

BR1103

CB1512 dx-sx

back cushion

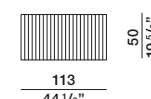

lumbar cushion

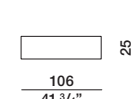

ornamental back cushion

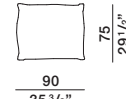

PCU90/75

storage armrest

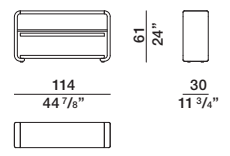

BR1103

DATASHEET

REGISTERED
DESIGN

2026

DIMENSIONS

central element

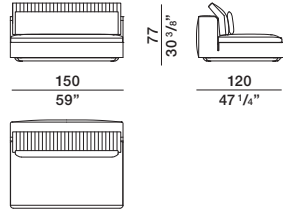

CE1512

central element for storage armrest

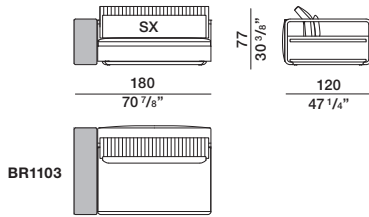

BR1103

CB1812 dx-sx

chaise longue

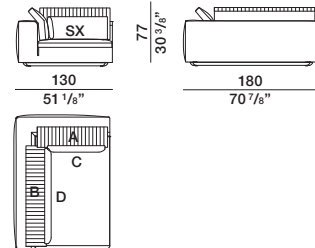

CL1318 dx-sx

chaise longue

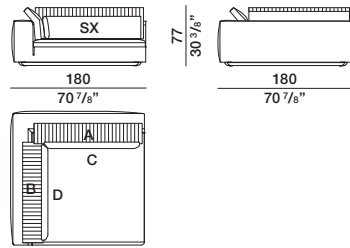

CL1818 dx-sx

daybed

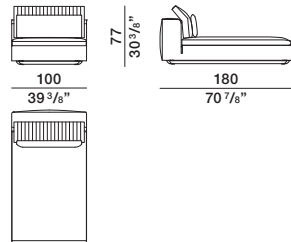

DA1018

back cushion

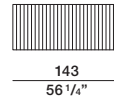

lumbar cushion

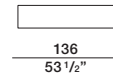

ornamental back cushion

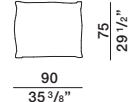

PCU90/75

back cushion

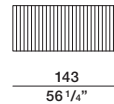

lumbar cushion

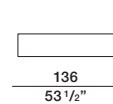

ornamental back cushion

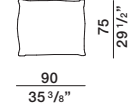

PCU90/75

storage armrest

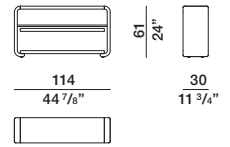

BR1103

back cushion A

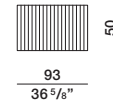

back cushion B

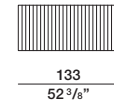

lumbar cushion C

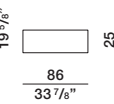

lumbar cushion D

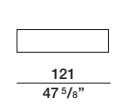

ornamental back cushion

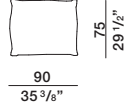

PCU90/75

back cushion A

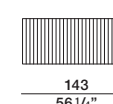

back cushion B



lumbar cushion C

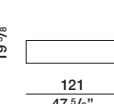

lumbar cushion D

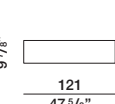

ornamental back cushion

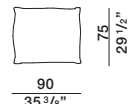

PCU90/75

back cushion

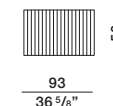

lumbar cushion

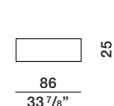

ornamental back cushion

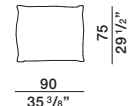

PCU90/75

DATASHEET

REGISTERED
DESIGN

2026

DIMENSIONS

daybed for storage armrest

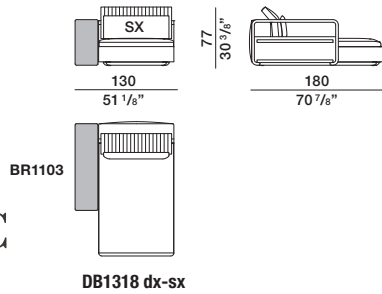

back cushion

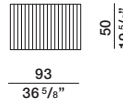

lumbar cushion

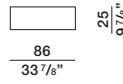

**ornamental
back cushion**

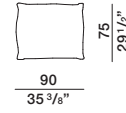

PCU90/75

storage armrest

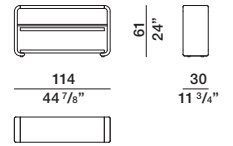

BR1103

pouf

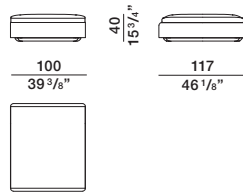

PF1012

trinket tray

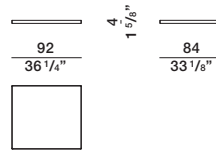

VP92/84

storage armrest

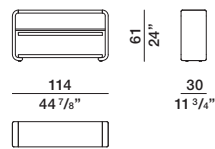

BR1103

corner small table

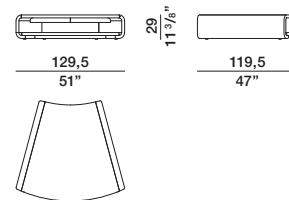

JTV1

DATASHEET

REGISTERED
DESIGN

2026