

# Molteni & C

## GLISS MASTER — VINCENT VAN DUYSSEN 2015

1—  
71



Gliss Master develops the concept of storage and space organisation. This approach permits maximum uniqueness and customisation. It is a tailor-made design for a wide range of doors, accessories and finishes, which creates systems adapted to individual needs. The Gliss Master range can be combined with accessories and different finishes, drawing on the components of each series to create exclusive solutions. The 2023 collection includes two new doors - Linear by Vincent Van Duysen and Blend by Rodolfo Dordoni, and a new set of accessories and interior customisations. It is a system that reflects the importance of a tailor-made approach for Molteni&C.

**DATASHEET**

REGISTERED  
DESIGN

2026

**moltenigroup.com**

Dimensions in millimeters and inches. The right to discontinue and make changes is reserved. This information is based on the latest product information available at the time of printing.

## FINISHES

Finishes		melamine structure	piqué melamine grain	fine melamine grain	melamine front	matt lacquer colours	3D matt lacquer colours	lunar	glossy lacquer colours	woods	pewter colour/bronze/iris	Eco Skin	BLEND fabric	coloured glass/etched coloured glass/mirror	glasses (see finishes)	3D etched bronze glass	MDi by Inalco
linear module and corner module	base/lid	•															
	back panel	•	•	•		•			•				•			• only linear	
wooden central partition		•															
wooden external side panel		•				•			•	•							
extension profile						•			•	•	•						
central partition or side panel frame or glass	frame										•						
	glass														• central only transparent		
FIND-ME door	finger recess					•			•		•						
	panel					•	•	•	•	•							
QUICK door *					• *												
START door					•	•	•		•	•							
"A FILO" door					•	•	•		•	•							
"A FILO" glass door	profile										•						
	glass													•			
BAMBOO door	profile										•						
	panel											•					
SMOOTH door	profile										•						
	panel											•	•				
HOLLOW door						•			•	•							
BLADE sliding door						•			•	•							
GRIP door						•			•	•							
NICHE door									•	• only vertical							
GLASS door	profile										•						
	glass														•		
SISTEMA 7 wood						•			•	•							
SISTEMA 7 glass	profile										•						
	glass														•		
LINEAR door						•	•	•									
LINEAR glass door	profile										•						
	glass														• excluding net	•	
BLEND door	door profiles					•			•								
	door panel					•						•					
	drawer front					•			•					• only mirror			
	top					•			•								
MERIDIAN door profiles	frame and internal										•						
	profilo esterno										•						
	decorativo														•		•
inserto																	

\* with handle and extension profiles side matched as per the table (see p. 64 price list)

\*\* see page 102 price list for matching finishes

# Molteni & C

2—  
71

### DATASHEET

REGISTERED  
DESIGN

2026

[moltenigroup.com](http://moltenigroup.com)

Dimensions in millimeters and inches. The right to discontinue and make changes is reserved. This information is based on the latest product information available at the time of printing.

## FINISHES

### Finishes

	melamine structure	piqué melamine	melamine structure	Eco Skin pewter colour/bronze/iris profile	fine grain pewter colour/bronze/iris profile	pewter colour/bronze/iris	transp. glass	grey saffiano melamine	larix dark/ silver cembran/ light chestnut and dark chestnut	matt lacquer colours	woods	BLEND fabric
--	--------------------	----------------	--------------------	--	--	---------------------------	---------------	------------------------	--	----------------------	-------	--------------

### internal fittings

shelf	•		•	•						•	•	
wooden drawer fronts H 126/190/382	•	•			•					•	•	•
tray front (trouser holders/trinket trays)	•	•			•					•	•	•
front for open drawers /pull-out trays	•	•								•	•	
glass drawer fronts/ glass shelf						•		•				
drawer internal								•				
central dividing panels	•		•							•	•	
sweater and shirt holder module	•											
SOFT LINE internal fittings				•								
island drawer unit									•	•		
drawer unit									•	•		
Island with glass top									•	•		

# Molteni & C

3—  
71

### colours

#### Melamine structure

YA silver cembran  
WW white  
YC sunrise chestnut  
QC light chestnut  
QS dark chestnut  
QA ivory tatami  
QG grey tatami

#### Melamine front

KA cartapaglia anthracite  
KB cartapaglia white  
KS cartapaglia silica  
ZB silk chalk white  
ZS silk silica  
ZT silk dove grey  
YC sunrise chestnut  
QC light chestnut  
QS dark chestnut  
QA ivory tatami  
QG grey tatami

#### Matt lacquer

#### 3D matt lacquer

#### Glossy lacquer

#### Coloured glass

#### Etched coloured glass

BC chalk white  
PE pearl  
DN dune  
PL platinum  
NE black  
AT anthracite  
SE mustard  
SI silica  
DO dolomite grey  
AL clay  
MK moka  
CZ light blue grey  
SA sand  
RU ruby  
PX pewter colour  
RX copper  
TO dove grey  
PR petroleum blue  
BG burgundy  
LS london sky  
SU stardust  
ML moonlight  
SP spice  
PG pine green  
AW almond white  
CP cappuccino  
IX iris  
FG forest green  
DB dark blue gray  
OY oz yellow

#### Woods

RC coffee oak  
RF graphite oak  
RS sunrise oak  
EU eucalyptus

#### Eco Skin

grey  
mink  
hemp  
ivory  
dark brown  
earth  
arctic  
taupe

#### Glasses

transparent  
smoked  
bronze  
stopsol transparent  
stopsol silver  
stopsol bronze  
stopsol etched  
stopsol net

#### BLEND fabric

bark brown  
moss green  
olive green  
vanilla  
malachite  
hay  
moon  
storm  
river rocks

#### MDi by Inalco

gray brown  
merino white

### DATASHEET

REGISTERED  
DESIGN

2026

## TECHNICAL INFORMATION

### STRUCTURE

#### BASE

Chipboard panel covered in melamine facing with adjustable feet for free-standing support.

#### LID, CENTRAL PANEL AND BACK

Chipboard panel covered in melamine facing. Central panels have adjustable feet for free-standing support.

#### FINE GRAIN BACK PANEL

Chipboard panel covered in co-extruded ABS-PMMA cylinder-etched sheet, painted in a specific Molteni finish.

#### WOOD BACK PANEL

Chipboard panel covered in wood veneer in Oak (Quercus) or Eucalyptus (Eucalyptus globulus).

#### BACK, LID, SIDE AND CENTRAL PANELS (GLASS)

Perimeter frame in painted extruded aluminium with 4 mm thick tempered glass. Available in different finishes.

#### SIDE PANEL (MELAMINE-FACED)

Chipboard panel covered in melamine facing. Adjustable feet for free-standing support.

#### SIDE PANEL (MATT LACQUERED COLOURS OR GLOSSY COLOURS)

Chipboard panel covered in melamine facing. Exterior painted in the "Molteni Range" colours. Adjustable feet for free-standing support.

#### SIDE PANEL (WOOD)

Chipboard panel covered in melamine facing on the inside, and Oak (Quercus) or Eucalyptus wood (Eucalyptus Globulus) veneer on the outside. Adjustable feet for free-standing support.

#### CENTRAL PANEL FRAME

Perimeter frame in painted extruded aluminium.

#### COVER PROFILES AND RUNNERS

Extruded aluminium covered in melamine paper or painted, with dust protection profiles.

#### SIDE PANEL EXTENSION PROFILES

Anodised extruded aluminium, painted in the "Molteni Range" colours or covered in Oak or Eucalyptus wood veneer.

### DOORS

#### MELAMINE (QUICK - START - "A FILO" - HOLLOW - BLADE - GRIP)

Chipboard panel covered in melamine facing. Soft-close hinges and slide system. Handles in different materials and finishes.

MATT LACQUERED COLOURS, GLOSSY COLOURS OR GLAZE (FIND-ME - START - "A FILO" - HOLLOW - BLADE - GRIP - NICHE - BLEND - LINEAR - SISTEMA 7 WOOD)  
Chipboard panel covered in wood veneer or melamine facing, painted in the "Molteni Range" colours. Soft-close hinges and slide system. Handles in different materials and finishes. For the BLEND model, the panel is profiled with painted extruded aluminium.

#### WOOD (FIND-ME - START - "A FILO" - HOLLOW - BLADE - GRIP - NICHE - SISTEMA 7)

Chipboard panel covered in Oak or Eucalyptus wood veneer. Handles in different materials and finishes.

#### HINGED GLASS DOOR ("A FILO")

Chipboard panel covered in melamine facing, with mirror or 4 mm thick glass applied, painted in the "Molteni Range" colours.  
Perimeter profile in anodised extruded aluminium. Soft-close hinges.

#### SLIDING GLASS DOOR ("A FILO")

Frame in anodised extruded aluminium with mirror or 4 mm thick glass applied, painted in the "Molteni Range" colours. Soft slide system.

#### GLASS FLUSH SLIDING DOOR ("A FILO")

Frame in anodised extruded aluminium with mirror or 4 mm thick glass applied, painted in the "Molteni Range" colours. Soft slide system.

#### GLASS / SISTEMA 7 GLASS DOORS

Extruded aluminium frame with 4 mm thick glass, available in various finishes. Hinges with 180° opening, for swing doors. Patented folding mechanism for SISTEMA 7.

#### LINEAR GLASS DOORS

Extruded aluminium frame with 4 mm thick glass, available in various finishes. Hinges with 94° opening.

#### SMOOTH DOORS

Chipboard panel covered in melamine facing. Interior and exterior Eco Skin finish.

#### SISTEMA 7 WOOD DOOR

Honeycomb panel painted in the "Molteni Range" colours or covered in Oak or Eucalyptus wood veneer.  
Handle in painted extruded aluminium.  
Hinges with 180° opening for swing doors.  
Patented folding mechanism.

#### BAMBOO DOORS

Chipboard panel covered in melamine facing.  
External finish, doors quilted externally in Eco Skin.  
Perimeter profiles in painted extruded aluminium.

#### BLEND - SMOOTH FABRIC DOORS

Chipboard panel covered in melamine facing.  
Interior and exterior fabric finish.

### DATASHEET

REGISTERED  
DESIGN

2026

## TECHNICAL INFORMATION

### INTERNAL ACCESSORIES

**REMOVABLE SHIRT RACK BLOCK**  
Painted parts in phenolic veneer panel. Front tray made from chipboard panel covered in melamine facing. Bottom covered in eco leather.

**DRAWER UNIT STRUCTURE FOR FRAME PANELS**  
Chipboard panel with melamine facing, painted in a specific Molteni finish.

**INTERNAL SHELVES, DRAWER OR TRAY FRONT, MOVABLE TRAY BLOCK AND JUMPER AND SWEATER AND SHIRT RACK**  
Chipboard panel covered in melamine facing.

**INTERNAL SHELVES WITH FRONT PROFILE**  
Chipboard panel covered in melamine facing, front profile in painted extruded aluminium.

**INTERNAL SHELVES AND ISLAND TOPS IN ECO SKIN**  
Chipboard panel covered in melamine facing, front profile in painted extruded aluminium and upper cover in eco leather.

**WOOD SHELVES**  
Chipboard panel covered in wood veneer in Oak (Quercus) or Eucalyptus (Eucalyptus globulus).

**CLOTHES ROD**  
Tube in anodised aluminium. Rod support bracket in chromed plastic or Eco Skin version.

**GLASS FRONT, GLASS SHELVES AND ISLAND TOP**  
Extruded or painted aluminium. Tempered glass th. 4 mm.

**FINE GRAIN FRONT**  
Chipboard panel covered in co-extruded ABS-PMMA cylinder-etched sheet, painted in a specific Molteni finish. Perimeter profile in painted extruded aluminium.

**WOOD FRONTS**  
Chipboard panel covered in wood veneer in Oak (Quercus) or Eucalyptus (Eucalyptus globulus).

**INTERNAL DRAWER SIDES, TRAY, DRAWER DIVIDERS, AND LINEN TRAY**  
Chipboard panel covered in melamine facing.

**INTERNAL DRAWER BOTTOM AND TRAY**  
Chipboard panel covered in melamine facing.

**SHOE SHELF PROFILES AND TROUSER BARS**  
In anodised or painted extruded aluminium.

**PULL-OUT MIRROR**  
Metal frame with 4 mm thick mirror.

**HANDLES AND VARIOUS ACCESSORIES**  
Made with different materials and finishes.

**WOOD BASE, TOP AND SHELVES (ISLAND WITH GLASS DOORS)**  
Chipboard panel covered in Oak or Eucalyptus wood veneer.

**IONIZER**  
See technical data sheet enclosed with the product.

**LAUNDRY BAG**  
100% removable ecru cotton fabric. Follow the washing instructions on the label.

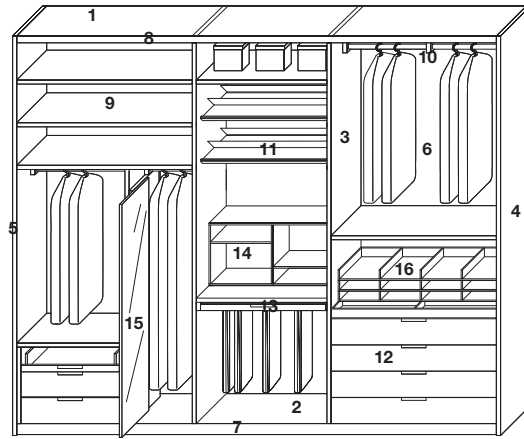

- 1 Cover
- 2 Base unit
- 3 Central panel
- 4 Side panel
- 5 Extension profile
- 6 Back panel
- 7 Cover profile or bottom rail
- 8 Cover profile or top rail
- 9 Shelf th. 30
- 10 Clothes rod
- 11 Shoe shelf
- 12 Drawers
- 13 Trouser- trinket tray
- 14 Sweater and shirt rack module
- 15 Pull-out mirror
- 16 Pull-out shirt rack block

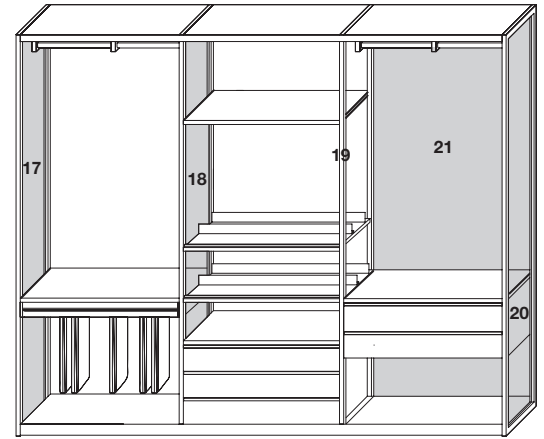

- 17 Glass side panel
- 18 Glass central panel
- 19 Frame central panel
- 20 Drawer unit structure
- 21 Glass back panel

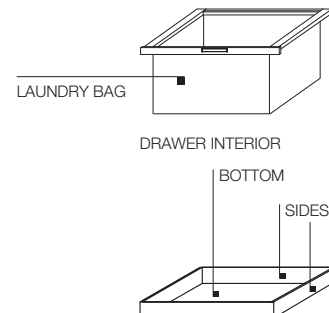

### DATASHEET

REGISTERED  
DESIGN

2026

## MODULARITY

### Modularity - Structure

The widths 492 - 656 - 820 - 984 - 1312 - 464 (term. element) mm (19 3/8" - 25 7/8" - 32 1/4" - 38 3/4" - 51 5/8" - 18 1/4") include the left side panel. The total width of the composition will include the final panel of th. 30 mm (1 1/8").

Heights:

tot. H 2343 (92 1/4"), door 2313 (91"), int. 2253 (87 3/4"), sliding or flush sl. door inter. 2163 (85 1/8")  
tot. H 2439 (96"), door 2409 (94 7/8"), int. 2349 (92 1/2"), sliding or flush sl. door inter. 2259 (88 7/8")  
tot. H 2631 (103 5/8"), door 2601 (102 3/8"), int. 2541 (100"), sliding or flush sl. door inter. 2451 (96 1/2")

tot. H 2919 (114 7/8"), door 2889 (113 3/8"), interior 2829 (111 3/8"), only hinged

### Assembly instructions

For the assembling of a sliding and a flush sliding door wardrobe a minimum space of 6 cm (2 3/8") is required considering the minimum height of the compartment.

Assembly of the corner element (for wardrobe with doors) requires a minimum extra height of 6 cm (2 3/8").

Assembly of a wardrobe in an alcove requires a minimum extra side space of 4 cm (1 5/8"). This space can be reduced to 15 mm by using special hardware provided on request for the side compartment. Surcharge per compartment.

This hardware may only be applied if there are open compartments, hinged doors (excluding SISTEMA 7) and wooden side panels.

Assembly of a hinged wardrobe requires a minimum height clearance of 1.5 cm, which varies with:

- MERIDIAN doors → 3,5 cm
- SISTEMA 7 hinged doors → 5 cm
- LED lighting with 'Smart' vertical bars → 3.5 cm
- LED lighting with horizontal bars → 2.5 cm

The minimum height drops to 1.5 cm if the compartment housing the lighting components, is fitted with inspection on top cod. **PAISPC01** (see page 33).

# Molteni & C

6—  
71

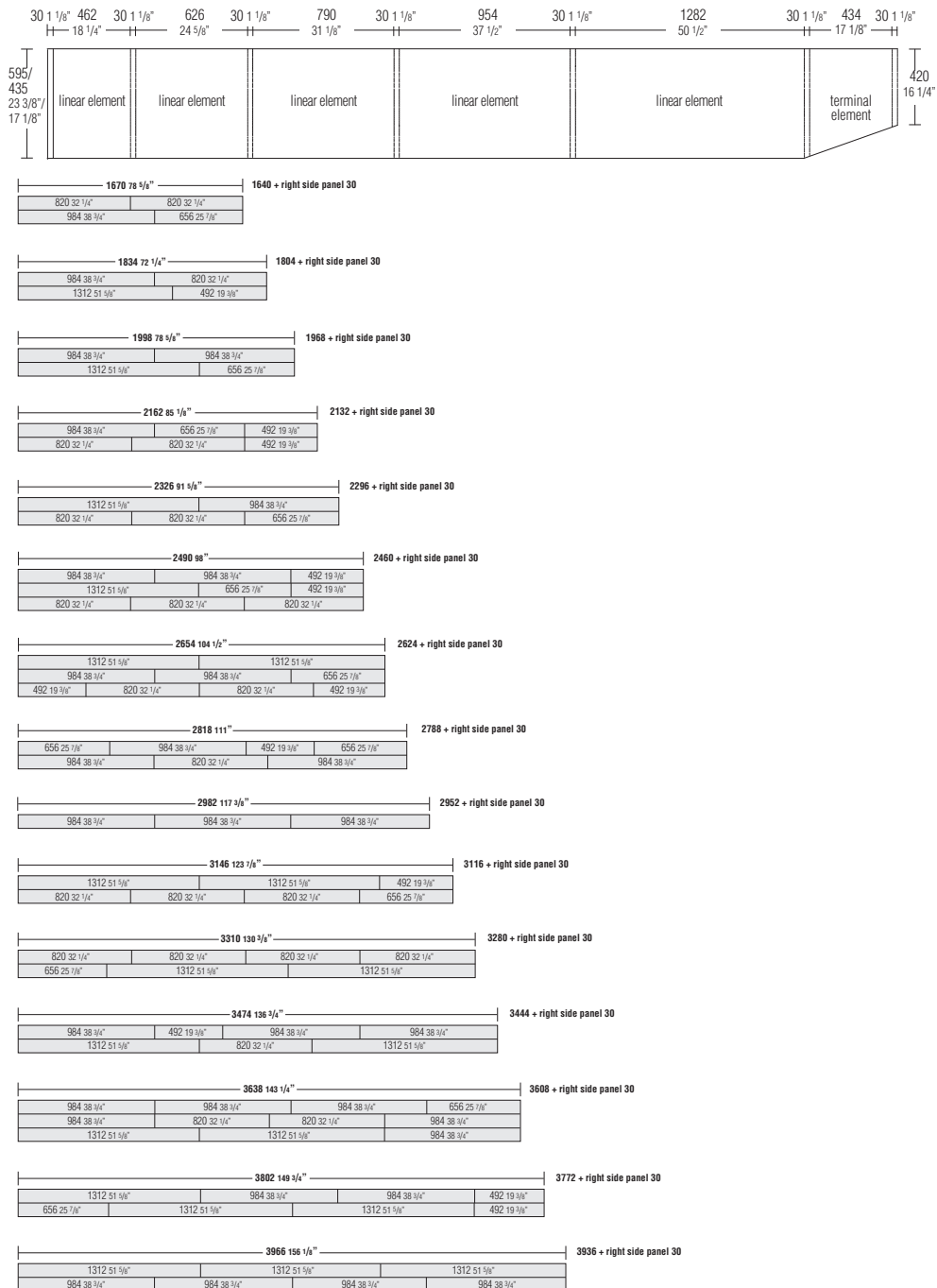

### DATASHEET

REGISTERED  
DESIGN

2026

**DOORS**

**START-HOLLOW  
hinged doors**

applicable only on structures with wood sides

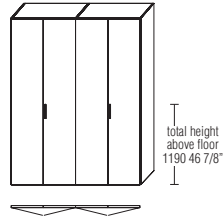

The pairs of hinged doors START and "A FILO" always have a handle mounted on the right door.

**FIND-ME-QUICK—"A FILO"—BAMBOO  
hinged doors**

applicable only on structures with wood sides

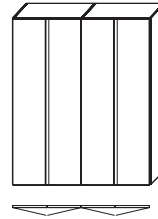

**GRIP-BLEND hinged doors**

applicable only on structures with wood sides

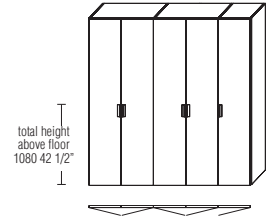

**NICHE doors**

applicable only on structures with wood sides

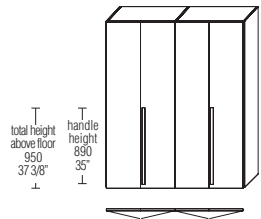

In the pairs of hinged doors W 815, 979 and 1307, are available 2 handles or handle only on right door.

**LINEAR door**

applicable only on structures with wood sides

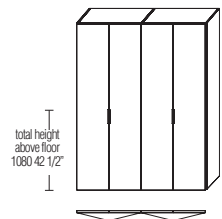

Hinged LINEAR doors are made with hinges concealed in the side panels

**GLASS-SISTEMA 7 doors, th 35  
MERIDIAN doors, th 42**

applicable on all types of structures

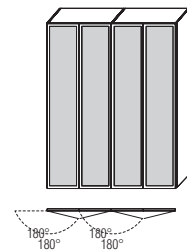

**Sliding doors**

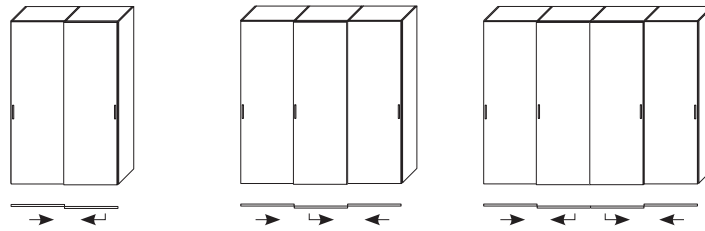

It is possible to make sliding door wardrobes with doors of the following types:  
- QUICK  
- START  
- "A FILO"  
- GRIP  
- BLADE

It is possible to make the external sliding door with two handles if using the QUICK, "A FILO" or BLADE door (full-height handle) and applying the surcharge

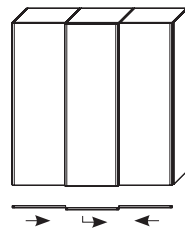

**Detail of side panel with extension profile**

**with BLADE door**

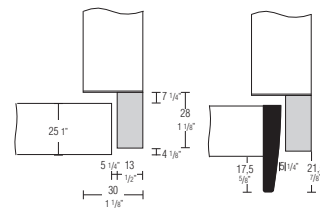

**Flush sliding doors**

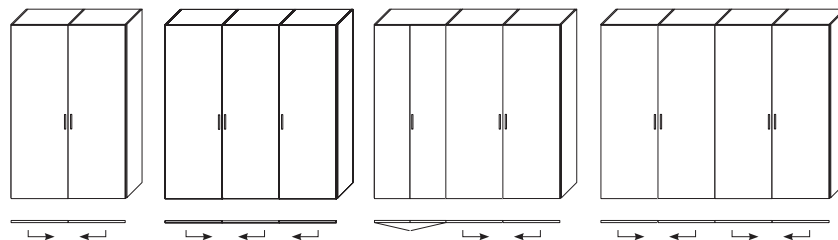

**DATASHEET**

REGISTERED  
DESIGN

2026

## DOORS

**155° opening (only for compartments with wooden sides)**

On **FIND-ME - QUICK - START - "A FILO" - BAMBOO - HOLLOW - GRIP - NICHE - BLEND** doors it is also possible to use **155° opening hinges**, with an **extra charge per individual door**. In this case, it is necessary to take special care in inserting internal drawer units, trinket trays and devices.

**155° hinges cannot be used on 'A FILO' doors (mirror and glass) with width over W 487.**

It is also necessary to comply with the diagrams provided here.

Molteni & C

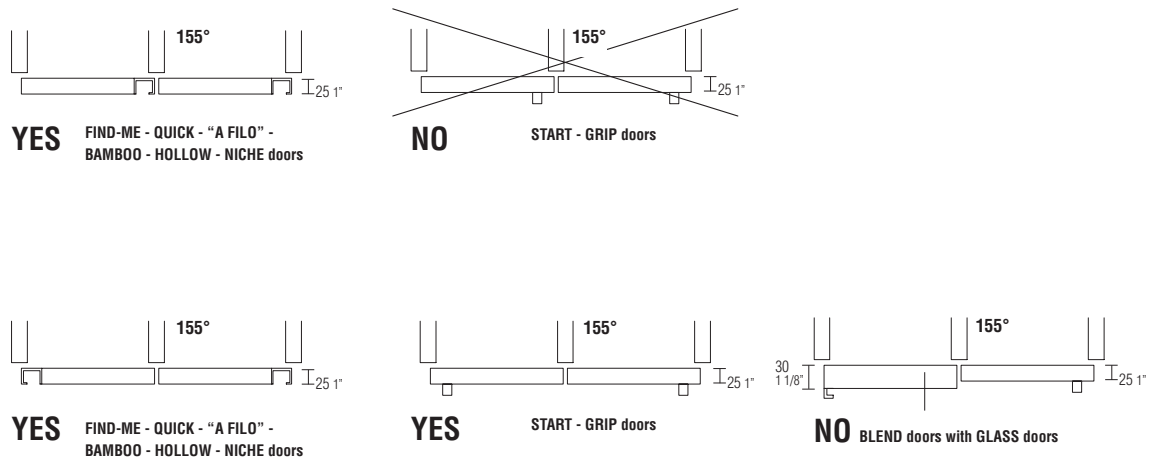

### Hinged doors with key lock

For the hinged doors specified, a key lock can be fitted to order. The additional cost for one or two doors. It can even be fitted on a terminal element or a corner element (in compliance with the handle installation rules).

For doors with a lock, the internal drawer units must be suspended.

Installation of only the lock can be requested, without a handle, always considering the price of the START doors and the additional cost of the lock.

For LINEAR doors, see page 106 price list because they have special locks.

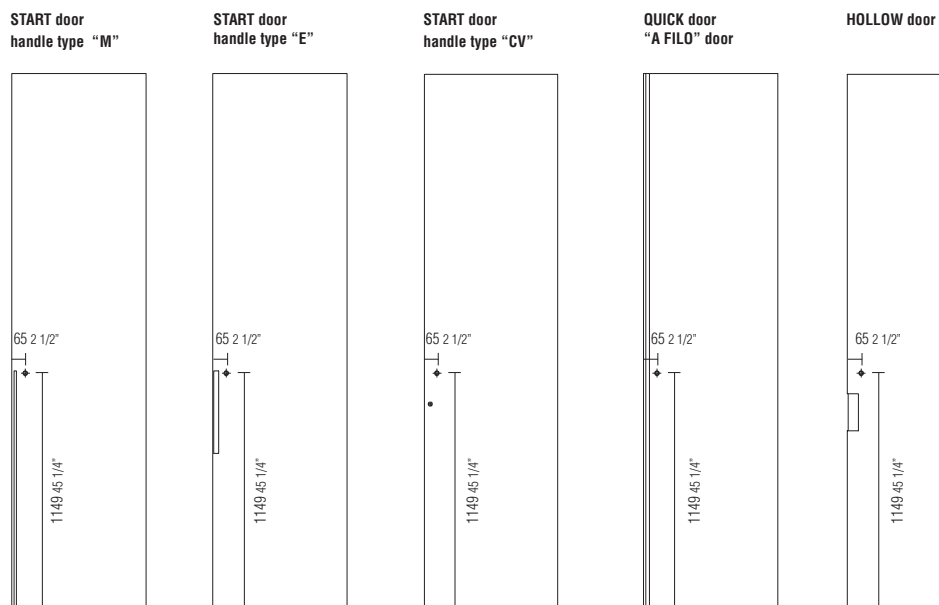

### DATASHEET

REGISTERED  
 DESIGN



## SISTEMA 7

A new folding opening system with a patented mechanism which makes it possible, in the 180° version, to open the unit entirely.  
The mechanism, light and silent, does not require tracks and therefore allows use of the full height.

The hinged doors enable 180° opening and wardrobe width made to order; the special hinge pins are anchored to the base and the cover.

**Anyhow, SISTEMA 7 hinge doors can be used (see p. 14/15 price list).**

The 90° opening, on the other hand, is an intermediate solution that can solve design problems while maintaining a uniform design.

The thickness of the wood and glass door are 35 mm.

SISTEMA 7 can be applied to all Gliss Master structures with wood, glass or frame sides, but cannot be used with other Gliss Master doors.

The 90° and 180° folding door is applied to modules with width 790 and 954, while the hinged door is applied to single modules 380/462/626, double modules 790/954/1282 and the corner unit (see pag. 16 price list).

The 380 mm unit is specific for SISTEMA 7 with hinged door.

### Reductions

90° and 180° folding openings can be reduced in height only.

180° hinged openings can be reduced in height and in width up to 405 mm.

### Notes

The side panels follow the same logic as Gliss Master (see drawing ●).

# Molteni&C

9—  
71

★ = 180° Hinged (necessary for 180° opening and for wardrobes with width made to order)

### 90° Folding opening

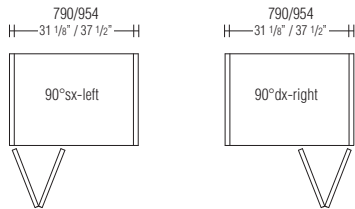

If the 90° folding door is on an end unit with external door, provide filler:  
50 mm (790 compartment)  
120 mm (954 compartment)

### 180° Folding opening

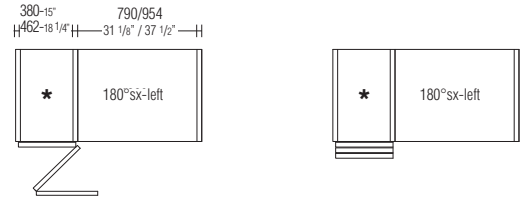

### Mixed 90°/180° Folding openings

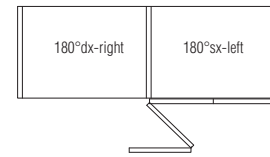
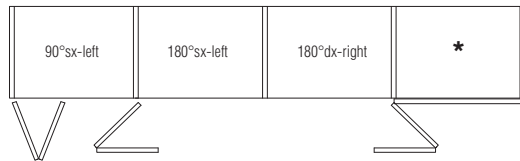

### 180° Corner opening

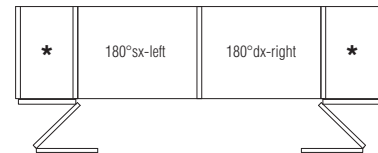
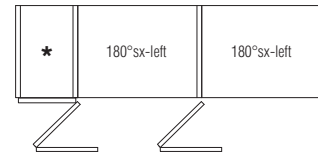
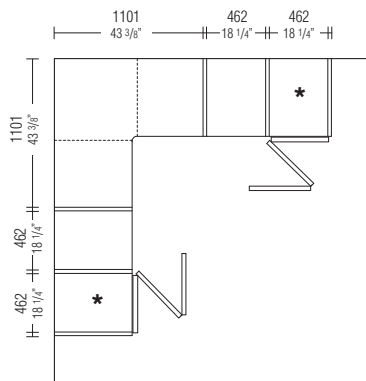

wooden  
side panels  
(●)

glass  
side panels  
(●)

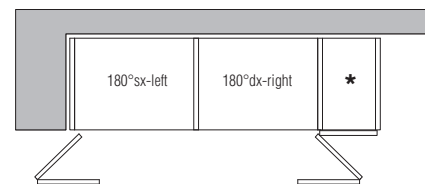

DATASHEET

REGISTERED  
DESIGN

2026

## CORNER ELEMENT

### Open corner element P 595

The open corner element is supplied complete with base, top and backs.  
The melamine-faced, frame or glass central partitions must be inserted between the corner element and the adjacent modules.  
The open corner element can also receive a side panel to close the composition.

Doors can be applied to the open corner element by following the rules below:

- GLASS door (180°) on corner element 1282x1282 / 1101x1101 with all types of side panels (wood, frame or glass);
- SISTEMA 7 door (180° hinged and 180° folding) only on corner element 1101x1101 with all types of side panels;
- QUICK and "A FILO" door (155°) only on corner element 1101x1101 with wooden side panels.
- LINEAR door only on corner element 1101x1101 with wooden side panels.
- MERIDIAN door (180°) only on corner element 1101x1101 with all types of side panels.

Compartments adjacent to the corner element can be either open or closed with the same door model.

### Notes

The shelf is not included in the price of the corner element.  
LED lighting bars can be applied to the shelves and lids, as shown in the drawing below.  
Not possible with glass back panels.

### Reductions

The corner element can be reduced in height, width and depth.  
Width reduction can only be performed on one side or on both sides up to a minimum width of 1101 mm.  
See method on price list page 32

Depth reduction can be performed on either one or two sides up to a minimum depth of 435 mm. If only one side is reduced, it will be the one with the longer shelves (\*).

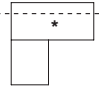

Molteni & C

10—  
71

### Solution with GLASS door

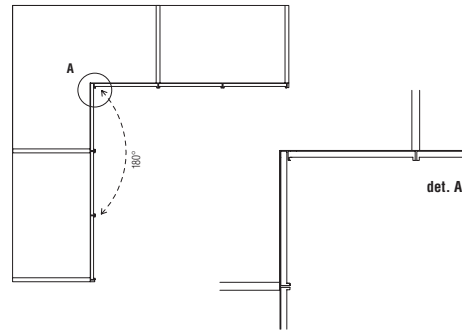
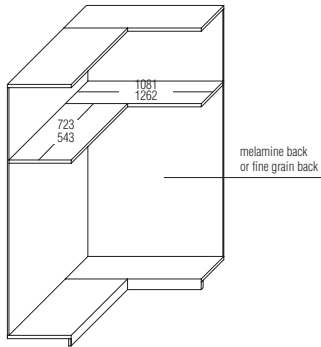

### Solutions with SISTEMA 7 (only for corner element 1101x1101)

#### 180° folding

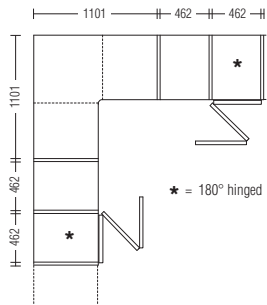

#### 180° hinged

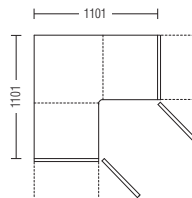

### Solution with QUICK, "A FILO", and LINEAR\*, MERIDIAN\* doors (only for corner element 1101x1101)

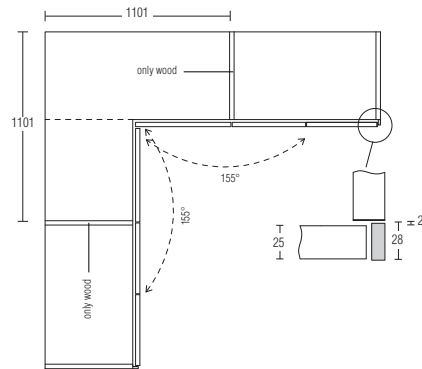

The corner element can be fitted with shelves and clothes rails, or with this solution of drawer units that have a central partition H 1158 where the desired drawer unit can be inserted. The drawer unit can be with fronts W 420 or 584.

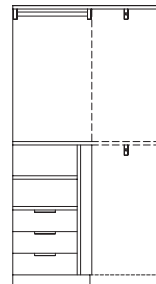
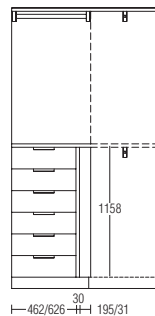
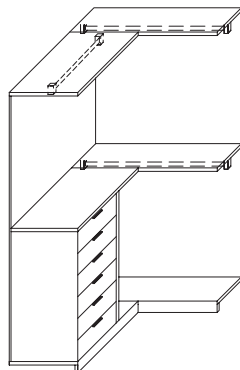

No type of drawer unit can be inserted with frame or glass sides

### Placing LED lighting bars

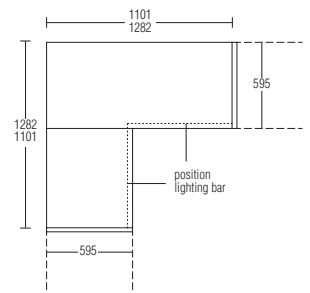

### DATASHEET

REGISTERED  
DESIGN

2026

## STRUCTURE

### Structure for walk-in closet

In version **A**, the structure (base, cover, centre and side panels) has melamine facing in the same finish as the structure.

The back panel can be made in the finishes on the price list (see price list page 8).

The side panels are always provided without extension profile (see detail).

In version **B**, the central partitions and sides are made with an aluminium frame with pewter colour, bronze or iris finish, with or without glass.

Base, lid and back piece are in melamine, in the same finish as the structure.

The back panel can be made in the finishes on the price list (see price list page 8).

Horizontal tags on the base and lid are made in a pewter colour, bronze or iris finish like the side frames.

In version **C**, given the presence of frame sides in pewter colour finish, the central and side partitions in melamine are also made with front tags in pewter colour, bronze or iris, considering the specific price.

### Reductions

See procedures on price list page 32.

### \*\* Notes

The central melamine sides with front profile, frame and glass are available with an Eco Skin insert, only for use in walk-in closets

\* Glass back panel (H max 2631) not available in the linear compartment W 1282 and in the corner element

# Molteni & C

11—  
71

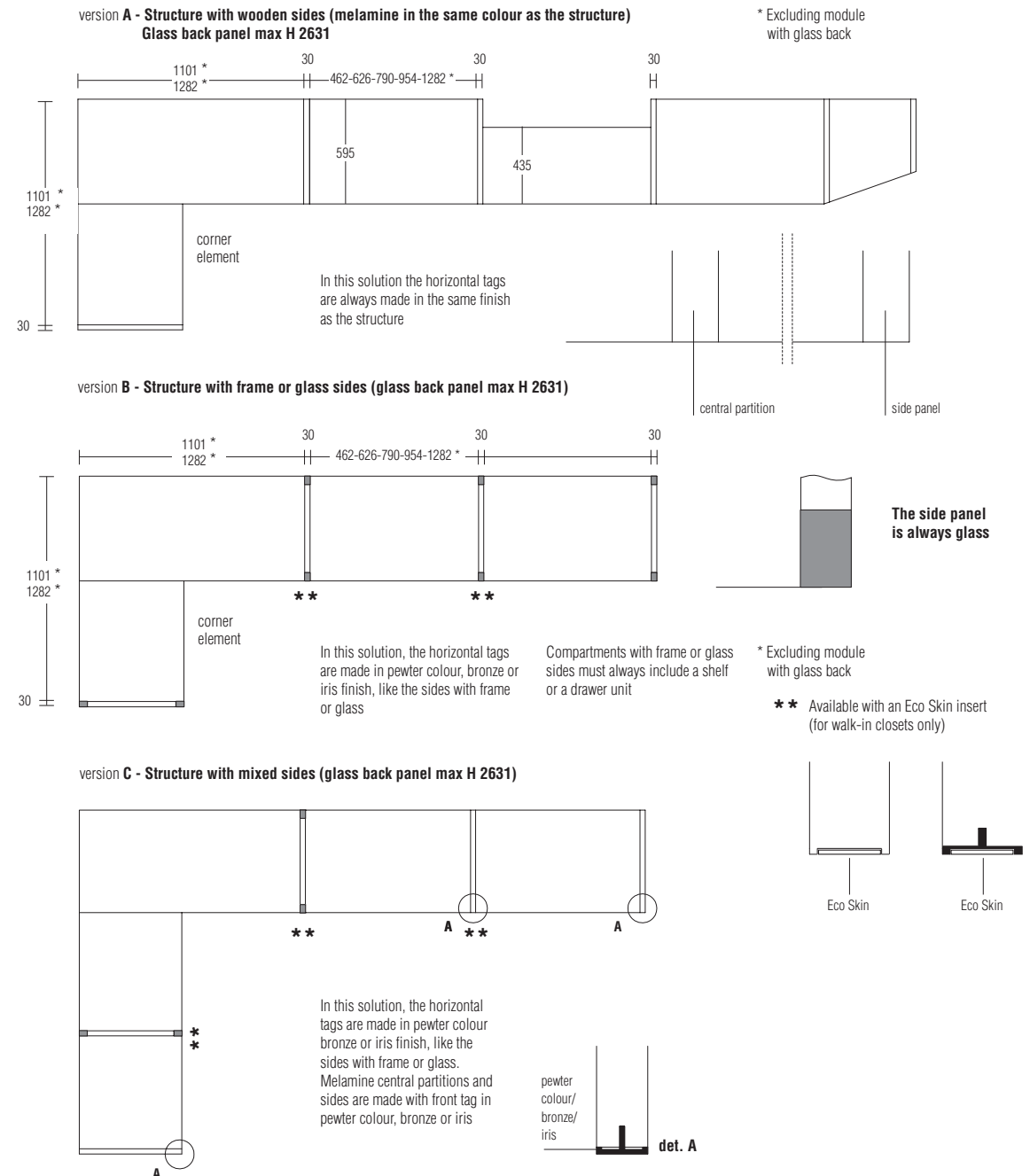

## STRUCTURE

### Linear modules

Linear modules are made up of a base and lid always made in melamine in the same finish as the structure.

The back is available in the three versions indicated below.

**A1** and **A2** can be reduced in height, width and depth if closed by sides and doors that are compatible with the requested reductions.

**A3** can be reduced only in height.

### Central partitions

These are available in melamine, in the same finishes as the structure, frame and glass. The melamine version can be reduced in height and depth.

The frame and glass versions can be reduced only in height.

Compartments with frame or glass sides must always include a shelf or a drawer unit.

A version with an Eco Skin insert is available for use in walk-in closets.

### Side panels

These are available in melamine, in the same finishes as the structure, frame and glass. The melamine version can be reduced in height and depth.

The side exterior is available also in matt lacquer, glossy lacquer or wood finish (vertical grain), as shown on p. 8 price list.

The standard finish on side panels is an extension profile in the coloured matt lacquer, pewter colour, bronze, iris (to be specified in the Order). The extension profiles for glossy lacquer or wood side panels always match the side panels of the same finish.

The frame and glass versions can be reduced only in height.

Compartments with frame or glass sides must always include a shelf or a drawer unit.

### Reductions

See procedures on page 32 price list.

# Molteni & C

12—  
71

### A1 - Melamine back

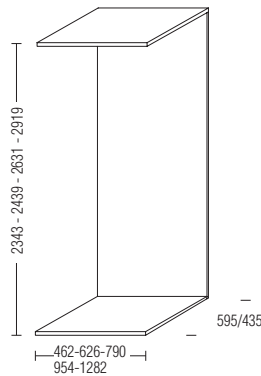

#### A1

Base, lid and back made in melamine finish matching the structure. The back is available also in piqué

### A2 - Back in fine grain, matt lacquered colours, wood or BLEND fabric

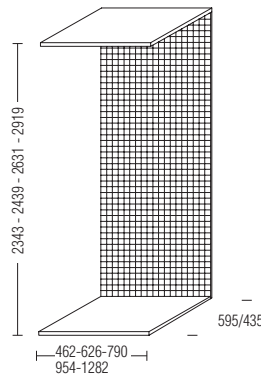

#### A2

Base and lid made in melamine finish matching the structure. Back in fine grain, matt lacquered colours wood or BLEND fabric.

### A3 - Glass back (only hinged GLASS, closet and SISTEMA 7 glass)

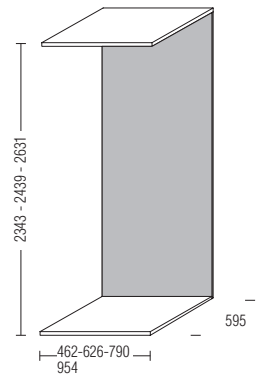

#### A3

Base and lid made in melamine finish matching the structure. It is possible to produce single finished modules W 790/954 with lateral pieces in glass by using the glass lids (see p. 59 price list)

### Central partitions, th 30

#### Warning:

frame sides and glass sides will only have holes at the position of the shelves. Complete hole series at regular intervals 96 mm will involve an extra charge per side.

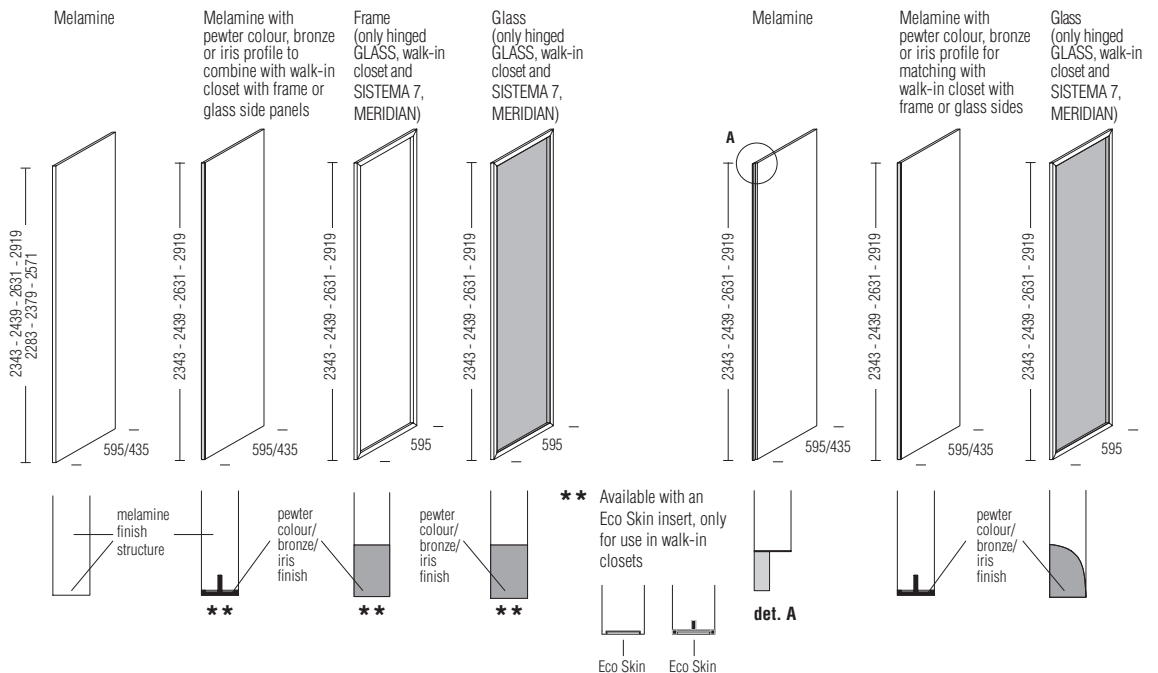

DATASHEET

REGISTERED  
DESIGN

2026

moltenigroup.com

Dimensions in millimeters and inches. The right to discontinue and make changes is reserved. This information is based on the latest product information available at the time of printing.

## TWO-SIDED CORNER WARDROBE COMPOSITIONS WITH OUTWARD SWING DOORS

Many of the solutions described below can be created with Gliss Master.  
These layouts can be installed either with or without the external corner module.

\*\* For this side, please consider the wooden side panel surcharge.

Molteni & C

13 —  
71

Solution A:  
Outward swing doors  
(NO glass back panels)

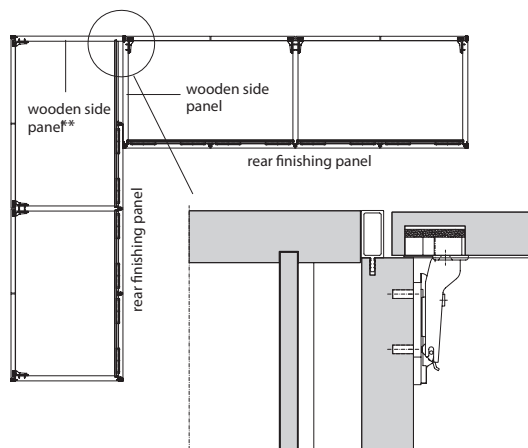

Solution B:  
Outward swing door + Walk-in Closet  
(NO glass back panels)

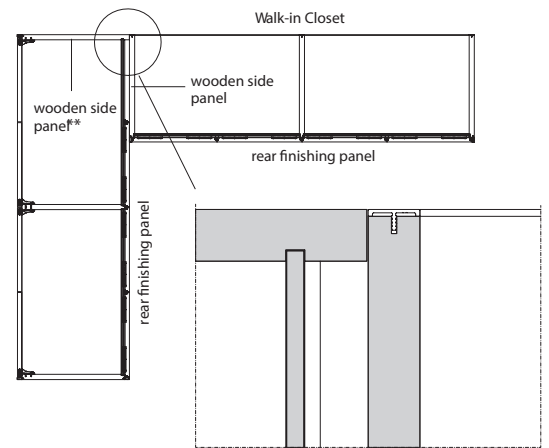

Solution C:  
Outward swing door + Inward swing door  
(example with glass back panels)

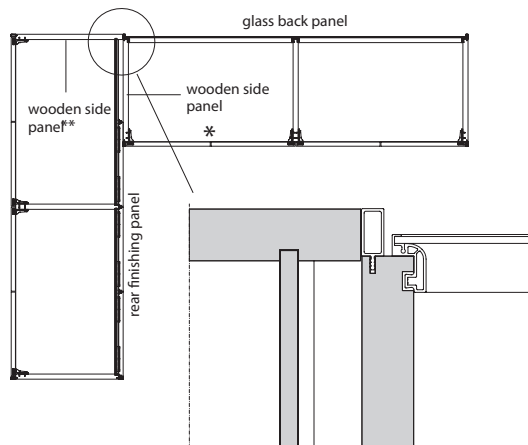

Solution D:  
Outward swing door + Inward swing door  
(example with rear finishing panel)

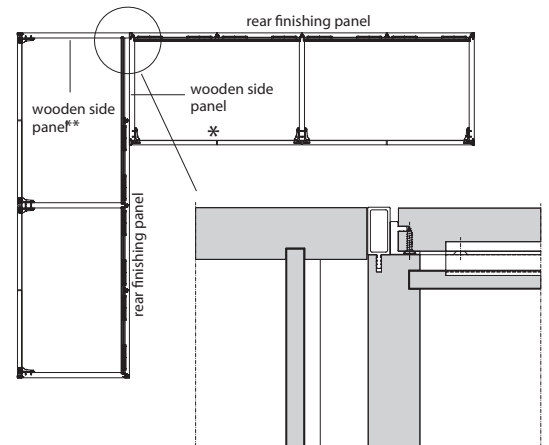

\* This compartment can be closed with a QUICK, "A FILO" and NICHE door (vertical and horizontal).  
For glass backs, drawer units are mandatory for compartments with frame or glass sides.  
For melamine structure, pique, matt lacquered colours, wood or fine grain backs, use drawer units that are narrower than the module.

DATASHEET

REGISTERED  
DESIGN

2026

moltenigroup.com

Dimensions in millimeters and inches. The right to discontinue and make changes is reserved. This information is based on the latest product information available at the time of printing.

## EXTERNAL CORNER UNIT

### External corner unit

- It can be either open or fitted with doors.
- It is always secured to the melamine central partitions of the adjacent wardrobes.
- The front profile can have a matt lacquered, pewter colour, bronze and iris finish.
- Height, width and depth can be reduced.
- The external corner unit can be closed in all hinged door models.

### Reductions

The external corner unit can be reduced in height, width and depth.

\* For this side, please consider the wooden central partition surcharge.

# Molteni & C

14—  
 71

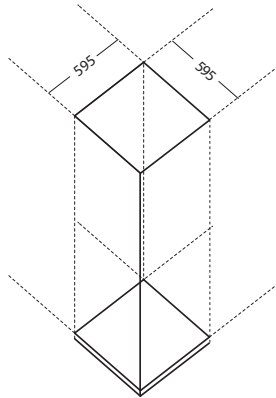

Solution A:  
 with Doors

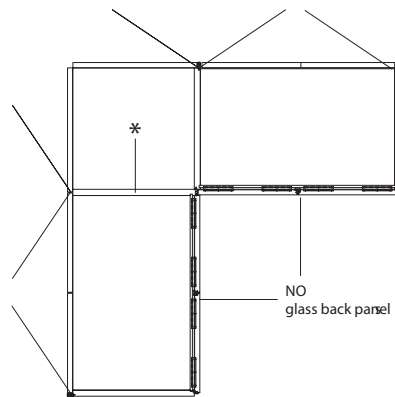

Solution C:  
 Doors and Walk-in Closet

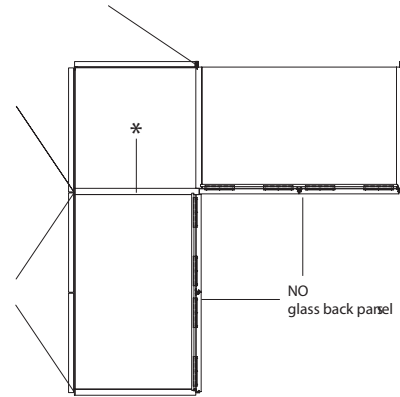

Solution B:  
 Walk-in Closet

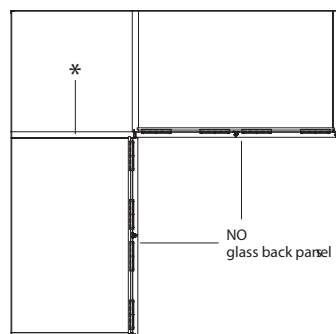

Solution D:  
 Doors and Walk-in Closet

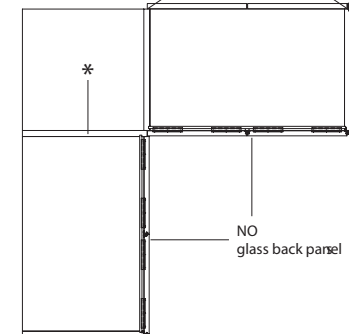

### DATASHEET

REGISTERED  
 DESIGN

2026

## WARDROBE REDUCTIONS

### Structure reductions

Type of reduction	height	width	depth
Linear modules D 595 mm <small>melamine, fine grain, matt lacquered colours, woods, BLEND fabric back</small>	per millimetre		min -20 mm max -256 wardrobe / flush sliding ward. max -160 mm
Linear modules D 595 mm glass back	per millimetre	no reductions	no reductions
Linear modules D 595 mm for BLEND drawers	no reductions	no reductions	no reductions
Linear elements D 435 mm	per millimetre	per millimetre	min -20 mm max -96 mm
Corner element for wardrobe with doors	per millimetre	no reductions	no reductions
Open corner element	per millimetre	1 side up to 1101 x 1282	1 side up to mm 435 (see note page 16 price list)
		2 sides up to 1101 x 1101	2 sides up to mm 435
Terminal element	per millimetre	no reductions	no reductions
Wooden central partition or side panel	per millimetre		reductions depend on linear modules
Frame or glass side panel or central partition	per millimetre		no reductions
External corner unit	per millimetre	up to mm 435	up to mm 435

Should the depth of the linear structure be reduced to less than 495 mm, it will not be possible to use the standard MERIDIAN door with patented damper. It will be fitted with SISTEMA 7 type slow close hinge. The same goes for any reduction in depth of the open corner element.

### Door reductions

Type of reduction	height	width
Wooden hinged doors (FIND-ME - QUICK - START - BLEND - LINEAR - "A FILO" - HOLLOW - GRIP - NICHE)	per millimetre	per millimetre
"A FILO" glass hinged doors - Hinged doors SMOOTH	per millimetre	per millimetre
BAMBOO hinged doors	per millimetre	at -15 mm intervals
Wooden sliding doors (QUICK - START - "A FILO" - BLADE - GRIP)	per millimetre	ONLY doors W 979 and 1307 mm - reducible down to W 815 mm
"A FILO" glass sliding doors	per millimetre	no reductions
Wooden flush sliding doors (QUICK - START - "A FILO" - HOLLOW - GRIP)	per millimetre	no reductions
Flush sliding doors W 1471 mm cannot be reduced.		
"A FILO" glass flush sliding doors	per millimetre	no reductions
LINEAR / GLASS / MERIDIAN doors	per millimetre	reducible down to W 405 mm
SISTEMA 7 wood hinged door	per millimetre	reducible down to W 405 mm
SISTEMA 7 wood folding door	per millimetre	no reductions
SISTEMA 7 glass hinged door	per millimetre	reducible down to W 405 mm
SISTEMA 7 glass folding door	per millimetre	no reductions
BLEND external drawer (depth cannot be reduced)	no reductions	no reductions

### Reductions of internal fittings

Type of reduction	height	width	depth
Wood shelves		per millimetre	reductions depend on linear modules
Shelves with pewter colour profile		per millimetre	reductions depend on linear modules
Eco Skin shelves		per millimetre	reductions depend on linear modules
Glass shelves		per millimetre	reductions depend on linear modules
Clothes rails		per millimetre	
Central divider pieces	32 mm intervals		reductions depend on linear modules
Internal drawers / trinket trays, trouser holders and pull-out trays / grid with shirt and sweater holders / shoe rack shelves / pull-out shirt holders / SOFT LINE internal fittings / islands	no reductions	no reductions	no reductions
"Smart" drawer unit 2 drawers		per millimetre	no reductions
"Smart" drawer unit 3 drawers		per millimetre	no reductions
"Smart" drawer unit 4 drawers		per millimetre	no reductions

Horizontal and vertical light bars can be reduced with the supplementary charge included in the charge for cutting shelf and side panel.

### DATASHEET

REGISTERED  
DESIGN

2026

**SPECIAL PROCESSING - INSPECTIONS**

**Molteni & C**

16 —  
 71

**Inspection on lid  
 with removable panel  
 for 626/790/954/1282  
 compartments (only on  
 hinged door compartment)**

LED lights can also be  
 fitted on the top.  
 Only for compartments  
 with melamine sides.  
 Removable 10 th. panel  
 melamine finished structure

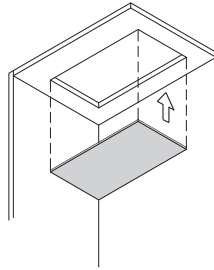

PAISPC01

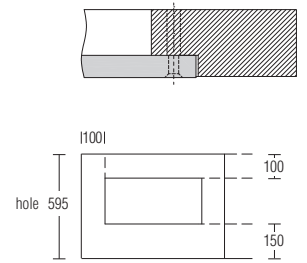

**Inspection on base  
 with removable panel  
 for 626/790/954/1282  
 compartments (only on  
 hinged door compartment)**

Only for compartments  
 with melamine sides.  
 Removable 10 th. panel  
 melamine finished structure

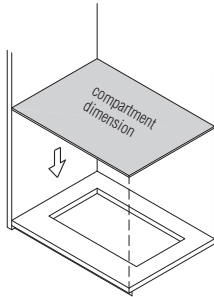

PAISPBA1

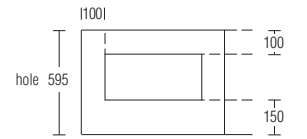

**Inspection on side panel  
 with removable panel**

Removable 10 th. panel  
 melamine finished structure.  
 Only one inspection possible  
 per side panel.

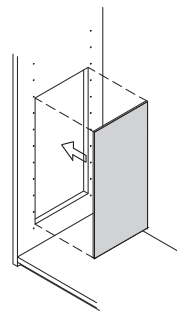

PAISPSP1

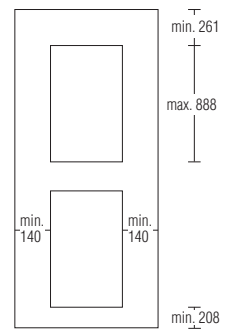

**DATASHEET**

REGISTERED  
 DESIGN

2026



**REMOVABLE BACK PANEL**

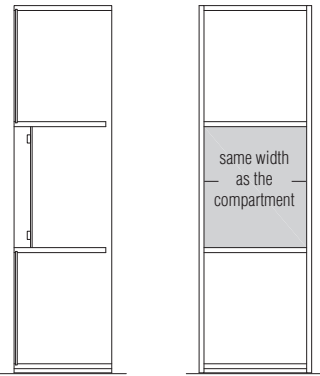

The removable back is made by dividing the back panel's structure, and adding two fixed shelves or 1 if starting from the base or top.  
 Not possible with BLEND fabric back panel.

**Molteni & C**

**Type 1**

**Type 1**

- Back cut
- Additional back panel at fixed price (for all finishes)
- Removable panel H max 1698 mm

melamine structure	matt lacquer	wood
W 462/626	W 462/626	W 462/626
W 790/954	W 790/954	W 790/954
W 1282	W 1282	W 1282

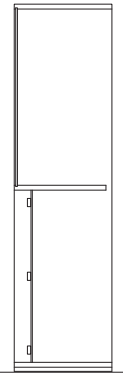

**Type 2**

- Back cut
- Removable panel H max 1734 mm

melamine structure	matt lacquer	wood
W 462/626	W 462/626	W 462/626
W 790/954	W 790/954	W 790/954
W 1282	W 1282	W 1282

**Type 2**

**SPECIAL PROCESSING - SHAPING**

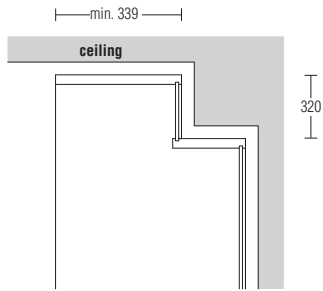

**Only on hinged door compartment**

- Costs to consider:
- Back cut
  - Lid cut
  - Fixed shelf with surcharge for cut (see page 131 price list for solid wood shelves)
  - Back, fixed price (for all finishes)
- Not possible with BLEND fabric back panel.

**Molteni&C**

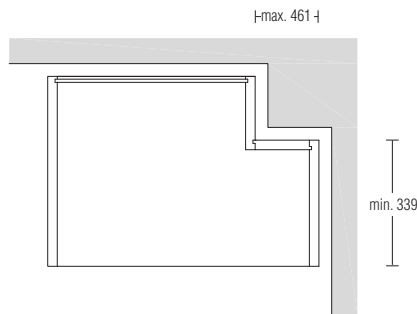

- Costs to consider:
- Back cut
  - Base/lid/shelf in solid wood
  - 2 cuts per shaped piece
  - 2 additional panels (melamine structure)
  - Possible cut in side

**18**—  
 71

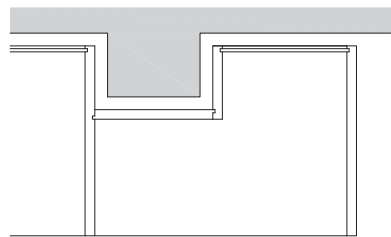

**Notes**

- Shaping in both height and width cannot be done on the same compartment.
- Confirmation to the customer of the feasibility of shaping will only be given after checking with the Molteni&C Technical Office.

**Custom cuts for attics**

**Doors with slanting cut (only for wardrobes with solid wood sides)**

When preparing the order, indicate heights H1 and H2, as well as the width L, as shown in the example.

The price for the slanting cut for each door is the same as cutting for a hinged door, as shown in the doors pages.

In this case a single module must be used with a QUICK, START, "A FILO", HOLLOW and GRIP hinged door, with the melamine facade and matt lacquered finishes, hinged on the higher side.

The structures can be standard or made to size.

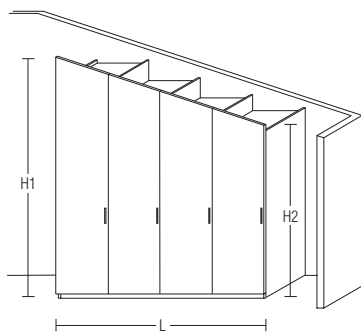

**Standard or made to size doors (only for wardrobes with solid wood sides)**

Double compartments with hinged doors can be used for this solution.

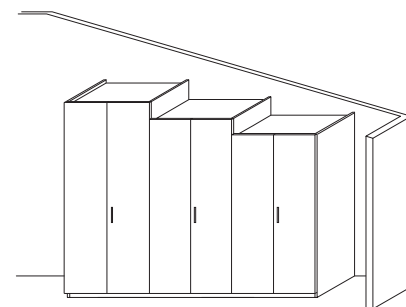

**DATASHEET**

REGISTERED  
 DESIGN

2026

GLISS  
MASTER—  
VINCENT  
VAN DUYSSEN  
2015

## GLASS TOP FOR WARDROBES FINISHED WITH ONLY ONE COMPARTMENT W 790/954

To use only with:  
- single linear module W 790 / W 954  
(no modular arrangement is possible)  
- only with glass lateral pieces and glass back panel  
- clothes rod cannot be mounted on the lid  
- cannot be used with SISTEMA 7 doors

**Glass finish**  
transparent glass  
transparent stopsol glass  
stopsol etched glass

**Profile finish**  
pewter colour  
bronze  
iris

# Molteni & C

19—  
71

Increase valid for depths 595 - 23 3/8"



W 790 - 31 1/8"

W 954 - 37 1/2"

**DATASHEET**

REGISTERED  
DESIGN

2026

**moltenigroup.com**

Dimensions in millimeters and inches. The right to discontinue and make changes is reserved. This information is based on the latest product information available at the time of printing.

**FIND-ME door th 25**

Door with full height vertical finger recess included in the door thickness.  
 The door is available in a hinged version in wood.

All the hinged doors have cushion-closing hinges.

**Hinges with 155° opening can be used and a key lock can be installed on hinged doors.**

**The FIND-ME door can be made with LINEAR invisible hinges for matt lacquered colours, 3D matt lacquer, lunar, and wood finishes with a cost supplement per door.**

**Reductions**

FIND-ME doors can be reduced as shown on p. 32 price list.

**Notes**

**With 3D lacquer and lunar surfaces, the outside of the side panel can be made with a matt lacquer finish or a laminate faced finish like the internal structure.**

**To match the lunar finish door, we advise the side exterior finish in clay matt lacquer with finger recess and extension profiles in pewter colour, bronze, iris.**

**Molteni & C**

20—  
 71

**FIND-ME wooden door**

- matt lacquer colours
- glossy lacquer colours
- vertical grain wood
- 3D matt lacquer colours
- lunar

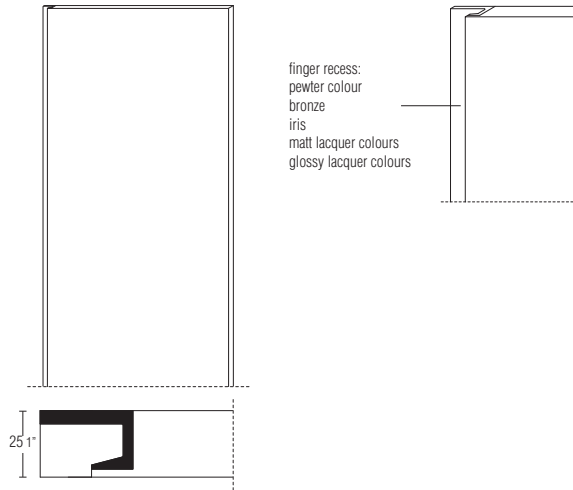

**finishes**

	matt lacquer colours	lunar	vertical grain wood	glossy lacquer colours	3D matt lacquer colours
<b>hinged doors</b>					
width 487 (19 1/8")	●	●	●	●	●
w. 651 (25 5/8")/608 (23 7/8")	●	●	●	●	●
width 815 (32 1/8")	●	●	●	●	●
width 979 (38 1/2")	●	●	●	●	●
width 1307 (51 1/2")	●	●	●	●	●
door for terminal element	●	●	●	●	●

**DATASHEET**

REGISTERED  
 DESIGN

2026

## QUICK door th 25

Door with full height handle included in the door thickness.

All the hinged doors have cushion-closing hinges.  
The sliding door have a shock absorber mechanism which allows them to open and close softly.  
**Hinges with 155° opening can be used and a key lock can be installed on hinged doors (see page 55 price list).**

### Reductions

QUICK doors can be reduced as shown on p. 32 price list.

### Notes

Sliding doors and flush sliding doors are not available in H 2889.

**With door in tatami melamine and chestnut finish, it is possible to make the structure and side panel in the same finish as the doors.  
Side extension profiles are made in the same finish as the handle.  
With cartapaglia and silk finished doors, the side panel exterior can be made with a finish in matt lacquered colours or a melamine finish like the internal structure.**

### QUICK door

Molteni & C

21—  
71

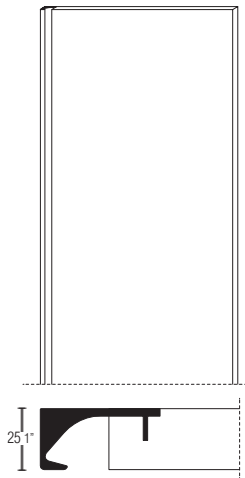

FINISHES TO MATCH THE QUICK DOOR		
DOOR PANEL	PROFILE HANDLE/ DOOR EXTENSION	EXTENSION PROFILE SIDE PANEL
Ivory Tatami	RAL7032	RAL7032
Grey Tatami	RAL7039	RAL7039
Light Chestnut Dark Chestnut Sunrise chestnut White cartapaglia Silica cartapaglia Anthracite cartapaglia Chalk white silk Silica silk Dove grey silk Ivory Tatami Grey Tatami	Epoxy finish Bronze or Epoxy finish Pewter Colour or Epoxy finish Iris	Epoxy finish Bronze or Epoxy finish Pewter Colour or Epoxy finish Iris

For handles matt lacquered in color with cartapaglia, silk and tatami melamine use "A FILO" doors

### hinged doors

width 487 (19 1/8")	●
w. 651 (25 5/8") 608 (23 7/8")	●
width 815 (32 1/8")	●
width 979 (38 1/2")	●
width 1307 (51 1/2")	●
door for terminal element	●
corner unit 1101x1101	●

### sliding doors

width 815 (32 1/8")	●
width 979 (38 1/2")	●
width 1307 (51 1/2")	●

### flush sliding doors

width 815 (32 1/8")	●
width 979 (38 1/2")	●
width 1307 (51 1/2")	●

### DATASHEET

REGISTERED  
DESIGN

2026

## START door th 25

Door with handles mounted on the front.

All the hinged doors have cushion-closing hinges.  
The sliding door have a shock absorber mechanism which allows them to open and close softly.  
**Hinges with 155° opening can be used and a key lock can be installed on hinged doors (see page 55 price list).**

**The START door can be made with LINEAR invisible hinges for melamine front, matt lacquered colours, 3D matt lacquer and wood finishes with a cost supplement per door.**

### Reductions

START doors can be reduced as shown on p. 32 price list.

### Notes

Sliding doors and flush sliding doors are not available in H 2889.

**With melamine front and 3D lacquer finishes, the outside of the side panel can be made with a matt lacquer finish or a melamine finish like the internal structure.**

#### START door

melamine cartapaglia  
tatami melamine  
melamine silk  
chestnut melamine  
matt lacquer colours  
3D matt lacquer colours  
glossy lacquer colours  
vertical grain wood

#### Type "E" standard

**Pewter colour structure with front insert:**  
matt lacquer colours  
woods

**Structure and front insert:**  
bronze  
pewter colour  
iris

#### Type "M" surcharge each

**Finish**  
pewter colour  
bronze  
iris

#### Type "CV" standard ONLY for hinged opening

**Finish**  
pewter colour  
bronze  
iris

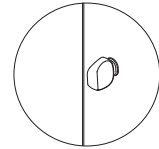
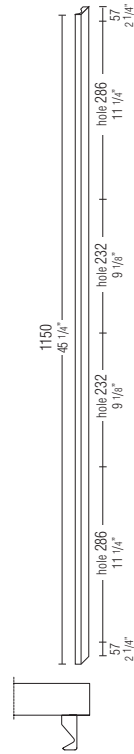
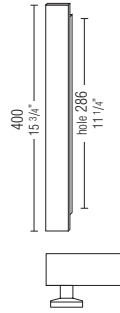
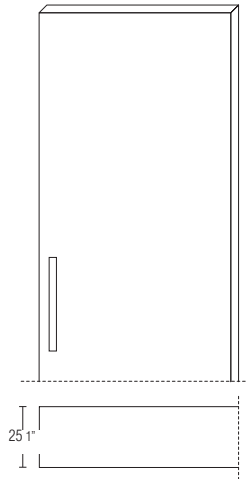

#### finishes

	melamine front	matt lacquer colours	vertical grain wood	glossy lacquer colours	3D matt lacquer colours
<b>hinged doors</b>					
width 487 (19 1/8")	●	●	●	●	●
w. 651 (25 5/8")/608 (23 7/8")	●	●	●	●	●
width 815 (32 1/8")	●	●	●	●	●
width 979 (38 1/2")	●	●	●	●	●
width 1307 (51 1/2")	●	●	●	●	●
door for terminal element	●	●	●	●	●
<b>sliding doors</b>					
width 815 (32 1/8")	●	●	●	●	
width 979 (38 1/2")	●	●	●	●	
width 1307 (51 1/2")	●	●	●	●	
width 1471 (57 7/8")		●		●	
<b>flush sliding doors</b>					
width 815 (32 1/8")	●	●	●	●	
width 979 (38 1/2")	●	●	●	●	
width 1307 (51 1/2")	●	●	●	●	
width 1471 (57 7/8")		●		●	

#### DATASHEET

REGISTERED  
DESIGN

2026

## “A FILO” door th 25

Door with full-height handle included in the thickness of the door.  
The door is available in the versions wood and glass.

All the hinged doors have cushion-closing hinges.  
The sliding door have a shock absorber mechanism which allows them to open and close softly.  
**Hinges with 155° opening can be used and a key lock can be installed on hinged doors (see page 55 price list).**

The “A FILO” door can be made with LINEAR invisible hinges for melamine front, matt lacquered colours, 3D matt lacquer and wood finishes with a cost supplement per door.

### Reductions

“A FILO” doors can be reduced as shown on p. 32 price list.

### Notes

Sliding doors and flush sliding doors are not available in H 2889.  
Glass hinged doors are not available in H 2889.  
Flush sliding glass doors cannot be used in compositions with 3 doors.

With surfaces in cartapaglia melamine, silk and 3D lacquer, the outside of the side panel can be made with a matt lacquer finish or melamine like the internal structure.

# Molteni & C

23—  
71

### “A FILO” wooden door

melamine cartapaglia  
melamine silk  
melamine tatami  
chestnut melamine  
matt lacquer colours  
3D matt lacquer colours  
glossy lacquer colours  
vertical grain wood

### “A FILO” glass door

Glass:  
coloured  
etched coloured  
mirror

Profile and “a filo” handle:  
pewter colour  
bronze  
iris

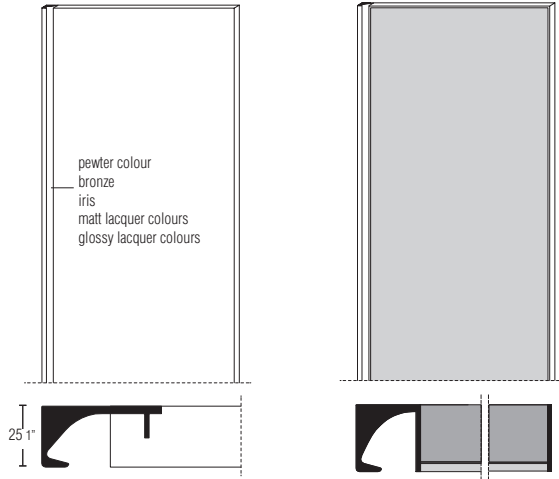

### finishes

	melamine front	matt lacquer colours	vertical grain wood	glossy lacquer colours	coloured glass/ etched coloured glass/ mirror	3D matt lacquer colours
<b>hinged doors</b>						
width 487 (19 1/8")	•	•	•	•	•	•
w. 651 (25 5/8")/608 (23 7/8")	•	•	•	•	•	•
width 815 (32 1/8")	•	•	•	•	•	•
width 979 (38 1/2")	•	•	•	•	•	•
width 1307 (51 1/2")	•	•	•	•	•	•
door for terminal element	•	•	•	•	•	•
corner unit 1101x1101	•	•	•	•	•	•
<b>sliding doors</b>						
width 815 (32 1/8")	•	•	•	•	•	
width 979 (38 1/2")	•	•	•	•	•	
width 1307 (51 1/2")	•	•	•	•	•	
width 1471 (57 7/8")		•		•		
<b>flush sliding doors</b>						
width 815 (32 1/8")	•	•	•	•	•	
width 979 (38 1/2")	•	•	•	•	•	
width 1307 (51 1/2")	•	•	•	•	•	
width 1471 (57 7/8")		•		•		

### DATASHEET

REGISTERED  
DESIGN

2026

**SMOOTH door th 25**

Door covered in Eco Skin or BLEND fabric in the colours in the Molteni range, featuring a full-height handle recessed in the width of the door and a perimeter profile that outlines the edge.

All the hinged doors have cushion-closing hinges.  
**Hinges with 155° opening can be used.**

**Reductions**

SMOOTH doors can be reduced as shown on p. 32 price list.

**Notes**

**With Eco Skin or BLEND fabric surfaces, the side panel exterior can be made with a matt lacquer finish or a melamine finish like the internal structure.**

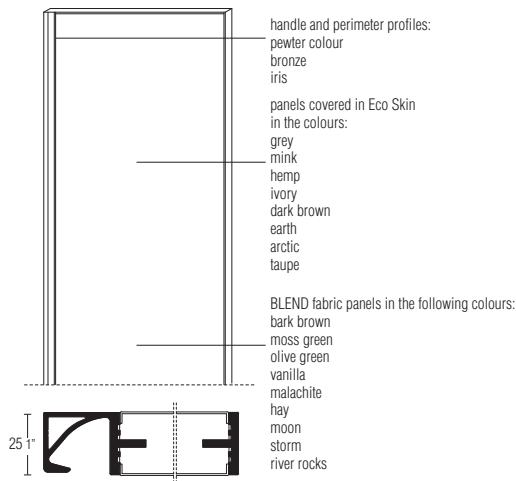

**finishes**

Eco Skin /  
 BLEND fabric

**hinged doors**

width 487 (19 1/8")	●
w. 651 (25 5/8")/608 (23 7/8")	●
width 815 (32 1/8")	●
width 979 (38 1/2")	●
width 1307 (51 1/2")	●
door for terminal element	●

**DATASHEET**

REGISTERED  
 DESIGN

2026



**BAMBOO door th 25**

Door covered in quilted Eco Skin in the colours of the Molteni range, characterized by a full-height handle recessed in the thickness of the door and by a perimeter profile that defines its contour.

All the hinged doors have cushion-closing hinges.  
**Hinges with 155° opening can be used.**

**Reductions**

BAMBOO doors can be reduced as shown on p. 32 price list.

**With fronts in Eco Skin finish, the outside of the side panel can be made with matt lacquer finish or in melamine in the same finish as the inside structure.**

**BAMBOO door**

Handle and perimeter profiles:  
 pewter colour  
 bronze  
 iris

Panels covered in Eco Skin  
 in the colours:  
 grey  
 mink  
 hemp  
 ivory  
 dark brown  
 earth  
 arctic  
 taupe

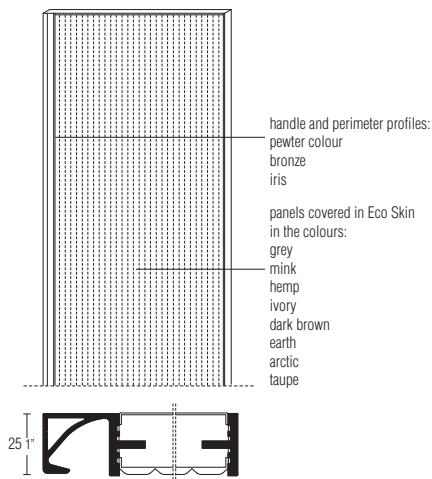

**finishes**

**hinged doors** Eco Skin

width 487 (19 1/8")	●
w. 651 (25 5/8") 608 (23 7/8")	●
width 815 (32 1/8")	●
width 979 (38 1/2")	●
width 1307 (51 1/2")	●
door for terminal element	●

**DATASHEET**

REGISTERED  
 DESIGN

2026

**HOLLOW door th 25**

Door characterized by the handle recessed in the thickness of the door.

All the hinged doors have cushion-closing hinges.  
 The sliding door have a shock absorber mechanism which allows them to open and close softly.  
**Hinges with 155° opening can be used and a key lock can be installed on hinged doors (see page 55 price list).**

**The HOLLOW door can be made with LINEAR invisible hinges for melamine front, matt lacquered colours, and wood finishes with a cost supplement per door.**

**Reductions**

HOLLOW doors can be reduced as shown on p. 32 price list.

**Notes**

Flush sliding doors are not available in H 2889.

**With the fronts in melamine front finish, the exterior of the side panel can be in matt lacquer or melamine finish like an internal structure.**

**HOLLOW door**

Panel:  
 melamine cartapaglia  
 melamine tatami  
 melamine silk  
 chestnut melamine  
 matt lacquer colours  
 glossy lacquer colours  
 vertical grain wood

Handle:  
 pewter colour  
 bronze  
 iris

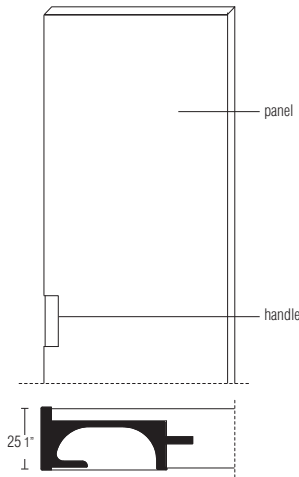

**finishes**

	melamine front	matt lacquer colours	vertical grain wood	glossy lacquer colours
<b>hinged doors</b>				
width 487 (19 1/8")	●	●	●	●
w. 651 (25 5/8")/608 (23 7/8")	●	●	●	●
width 815 (32 1/8")	●	●	●	●
width 979 (38 1/2")	●	●	●	●
width 1307 (51 1/2")	●	●	●	●
door for terminal element	●	●	●	●
<b>flush sliding doors</b>				
width 815 (32 1/8")	●	●	●	●
width 979 (38 1/2")	●	●	●	●
width 1307 (51 1/2")	●	●	●	●

**BLADE sliding door th 25**

Door with full-height handle.

The sliding system automatically aligns the door as it opens and closes.

**Reductions**

BLADE doors can be reduced as shown on p. 32 price list.

**Notes**

BLADE doors are not available with H 2889.

**With the fronts in melamine front finish, the exterior of the side panel can be in matt lacquer or melamine finish like an internal structure.**

Molteni & C

27—  
 71

**BLADE sliding door**

- melamine cartapaglia
- melamine tatami
- melamine silk
- chestnut melamine
- matt lacquer colours
- glossy lacquer colours
- vertical grain wood

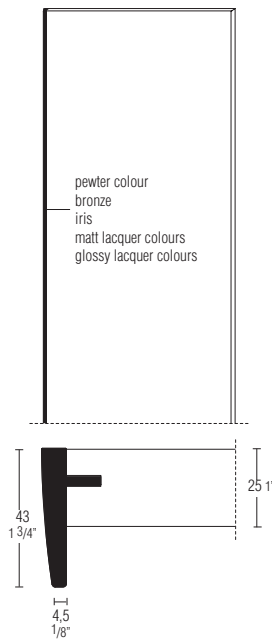

**finishes**

	melamine front	matt lacquer colours	vertical grain wood	glossy lacquer colours
<b>sliding doors</b>				
width 815 (32 1/8")	●	●	●	●
width 979 (38 1/2")	●	●	●	●
width 1307 (51 1/2")	●	●	●	●
width 1471 (57 7/8")		●		●

**DATASHEET**

REGISTERED  
 DESIGN

2026

## GRIP door th 25 design Vincent Van Duysen

Door with a handle applied laterally on the edge of the door.

All the hinged doors have cushion-closing hinges.  
The sliding door have a shock absorber mechanism which allows them to open and close softly.

**Hinges with 155° opening can be used on hinged doors (see page 55 price list).**

**The GRIP door can be made with LINEAR invisible hinges for melamine front, matt lacquered colours, and wood finishes with a cost supplement per door.**

### Reductions

GRIP doors can be reduced as shown on p. 32 price list.

### Notes

Sliding doors and flush sliding doors are not available in H 2889.

**In the pair of hinged doors, the handle is mounted on both doors in the pair.**

**With the fronts in melamine front finish, the exterior of the side panel can be in matt lacquer or melamine finish like an internal structure.**

### Handles finishes

pewter colour

bronze

iris

pewter colour/bronze/iris covered in Eco Skin in the colours (with surcharge per handle)

# Molteni & C

28—  
71

**GRIP door**  
melamine cartapaglia  
melamine tatami  
melamine silk  
chestnut melamine  
matt lacquer colours  
glossy lacquer colours  
vertical grain wood

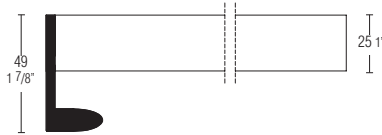
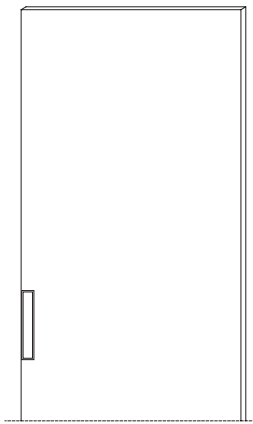

### finishes

	melamine front	matt lacquer colours	vertical grain wood	glossy lacquer colours
<b>hinged doors</b>				
width 487 (19 1/8")	●	●	●	●
w. 651 (25 5/8")/608 (23 7/8")	●	●	●	●
width 815 (32 1/8")	●	●	●	●
width 979 (38 1/2")	●	●	●	●
width 1307 (51 1/2")	●	●	●	●
door for terminal element	●	●	●	●
<b>sliding doors</b>				
width 815 (32 1/8")	●	●	●	●
width 979 (38 1/2")	●	●	●	●
width 1307 (51 1/2")	●	●	●	●
width 1471 (57 7/8")		●		●
<b>flush sliding doors</b>				
width 815 (32 1/8")	●	●	●	●
width 979 (38 1/2")	●	●	●	●
width 1307 (51 1/2")	●	●	●	●
width 1471 (57 7/8")		●		●

### DATASHEET

REGISTERED  
DESIGN

2026

**NICHE door th 25** design Vincent Van Duysen

Door with recessed handle.

All the hinged doors have cushion-closing hinges.

**Hinges with 155° opening can be used on hinged doors (see page 55 price list).**

**Reductions**

NICHE doors can be reduced as shown on p. 32 price list.

**Handles finishes**

- pewter colour
- bronze
- iris

**Molteni & C**

**NICHE door**  
 matt lacquer colours  
 glossy lacquer colours  
 vertical grain wood

**29**—  
 71

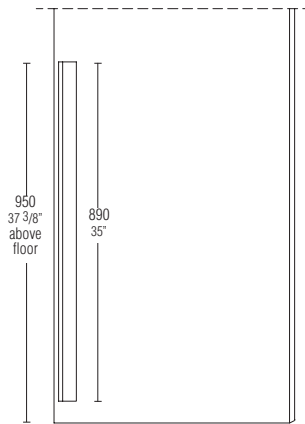

**finishes**

matt lacquer colours      vertical grain wood      glossy lacquer colours

**hinged doors**

	matt lacquer colours	vertical grain wood	glossy lacquer colours
width 487 (19 1/8")	●	●	●
width 651 (25 5/8")/608 (23 7/8")	●	●	●
width 815 (32 1/8")	●	●	●
width 979 (38 1/2")	●	●	●
width 1307 (51 1/2")	●	●	●
door for terminal element	●	●	●

**DATASHEET**

REGISTERED  
 DESIGN

2026

**BLEND door and external drawer** design Rodolfo Dordoni

Hinged doors with perimeter profile characterised by a vertical decoration and the possibility of being combined with an external lower drawer.

Molteni & C

30—  
 71

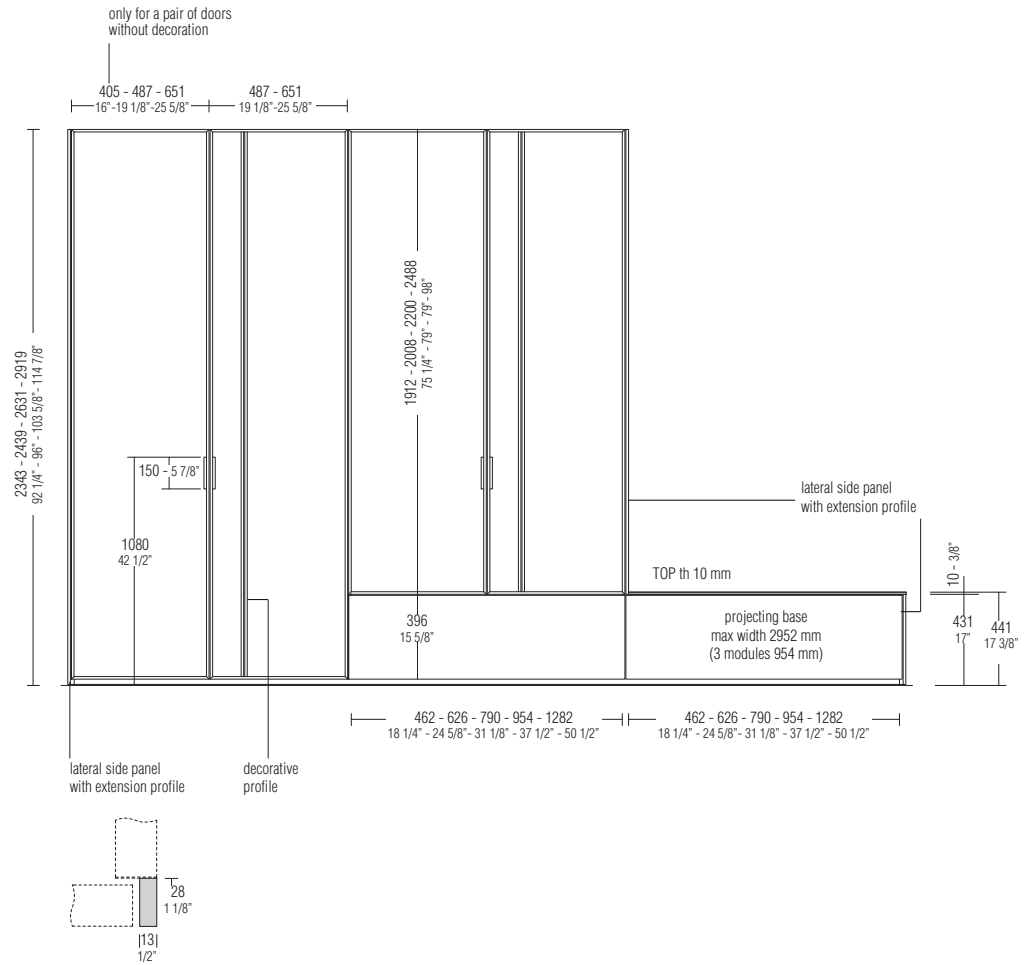

**Technical information**

- The hinged doors cannot be applied to frame or glass sides and to open corner units (1101x1101 - 1282x1282).
- The compartment above the drawer must always be closed with BLEND doors and cannot be equipped with central dividing sides.
- The protruding base, with one or more modules, must always be hooked to at least one side panel of the wardrobe.
- The decorative profile cannot be made on doors smaller than 487 mm wide.
- The drawer cannot be adjacent to the corner element (658x658).

**DATASHEET**

REGISTERED  
 DESIGN

2026

**BLEND door and external drawer** design Rodolfo Dordoni

All hinged doors are equipped with soft closing hinges.  
**It is possible to use hinges with 155° opening on hinged doors.**

**Notes**

In pairs of hinged doors, the handle is fitted on both doors.  
 The door covering fabrics are specific for this use and feature a water-repellent surface treatment (Scotchgard).

**Fabric colours**

- bark brown
- moss green
- olive green
- vanilla
- malachite
- hay
- moon
- storm
- river rocks

**Hinged door**

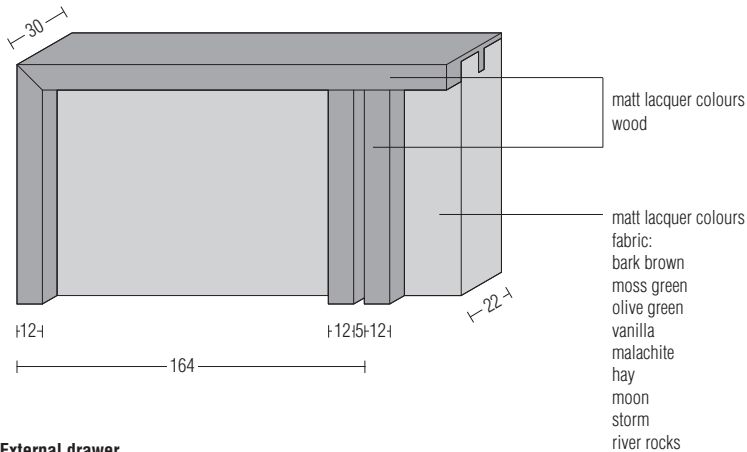

**External drawer**



**panel finishes**

	matt lacquer colours	fabric	wood	mirror
<b>hinged doors</b>				
width 487 (19 1/8")	●	●		
w. 651 (25 5/8")/608 (23 7/8")	●	●		
width 815 (32 1/8")	●	●		
width 979 (38 1/2")	●	●		
width 1307 (51 1/2")	●	●		
door for terminal element	●	●		
<b>external drawer</b>				
width 487 (19 1/8")	●		●	●
width 651 (25 5/8")	●		●	●
width 815 (32 1/8")	●		●	●
width 979 (38 1/2")	●		●	●
width 1307 (51 1/2")	●		●	●

**Handle**

always in pewter colour finish



**GLASS door th 35** design Vincent Van Duysen

Glass door with 180° opening made with a special soft close hinge inserted in the profile and completely hidden in the side (exclusively by Molteni).  
 A full height handle is designed in the profile.

**Integrated lock with coded key**

GLASS hinged doors with integrated lock are available, taking into account a surcharge for single door or pair of doors.  
 As standard, all lockable doors in a wardrobe will have different coded keys.  
 On the pair of doors, the lock will always be applied to the right door.  
 The lock is not applicable to hinged doors of the external corner units.

**Reductions**

GLASS doors can be reduced as shown on p. 32 price list.

**Notes**

The GLASS doors are available with H 2889 only for widths 487, 815, 979 and for the corner unit 1101x1101.

**In the pair of hinged doors, the handle is mounted on both doors in the pair.**

**The GLASS door can also be installed on the open corner module.**

Molteni & C

**GLASS door**

32—  
 71

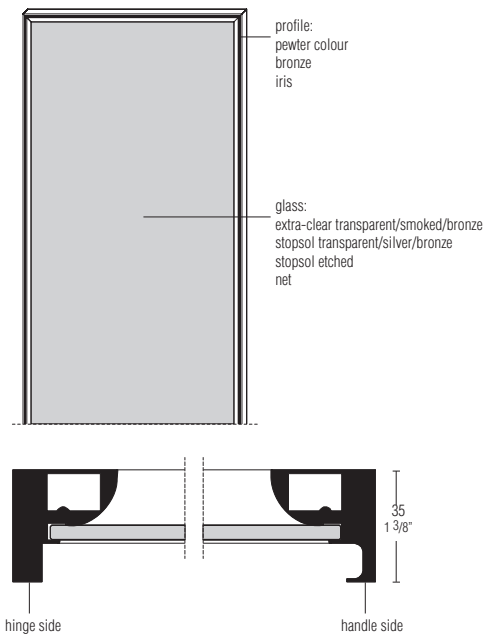

**finishes**

transparent /  
 smoked / bronze  
 glass

stopsol  
 transparent/silver/  
 bronze glass

stopsol  
 etched  
 glass

net  
 glass

**180° Hinged**

width 487 (19 1/8")	●	●	●	●
w. 651 (25 5/8")/608 (23 7/8")	●	●	●	●
width 815 (32 1/8")	●	●	●	●
width 979 (38 1/2")	●	●	●	●
width 1307 (51 1/2")	●	●	●	●
corner unit 1101x1101	●	●	●	●
corner unit 1282x1282	●	●	●	●

**DATASHEET**

REGISTERED  
 DESIGN

2026



## MERIDIAN door th 42 design Studio Klass

Hinged door with 180° opening fitted as standard with patented soft open/close hinges.  
 Door pauses at 110° with non-simultaneous closure of the pair.  
 MERIDIAN doors are available in three versions:  
 - Glass or MDi by Inalco door with external metal profiles  
 - Glass or MDi by Inalco door with external wood profiles  
 - Glass door with decorative and external wood profiles

For pairs of hinged doors W 815, 979 and 1307 the handle is fitted on both doors.

### Reductions

MERIDIAN doors can be reduced in height and in width up to 405 mm.

### Notes

Locks cannot be applied to MERIDIAN doors.  
 When the MERIDIAN door is used on a linear structure less than 495 mm deep or on an open corner structure with reduced depth, the patented soft close hinge cannot be used.  
 The door will be fitted with SYSTEM 7 type slow close hinge.  
 Doors in MDi by Inalco are not available in 2889 height.

**MERIDIAN glass or MDi by Inalco door**  
 with external profiles in metallic or wood finish

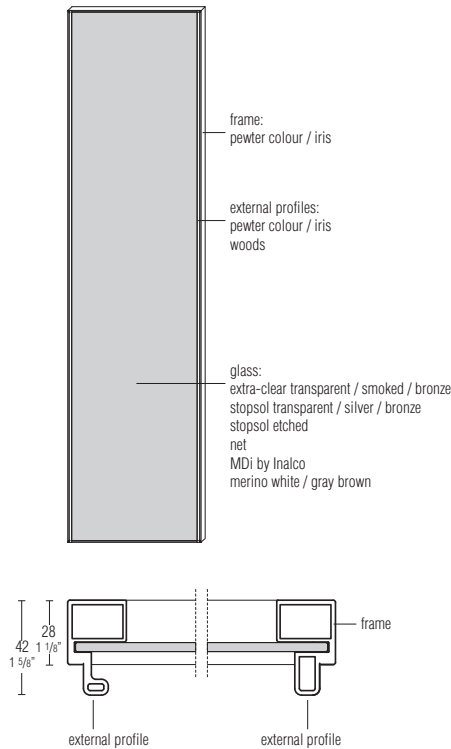

**MERIDIAN glass door with decorative profiles**  
 with external and decorative profiles in wood

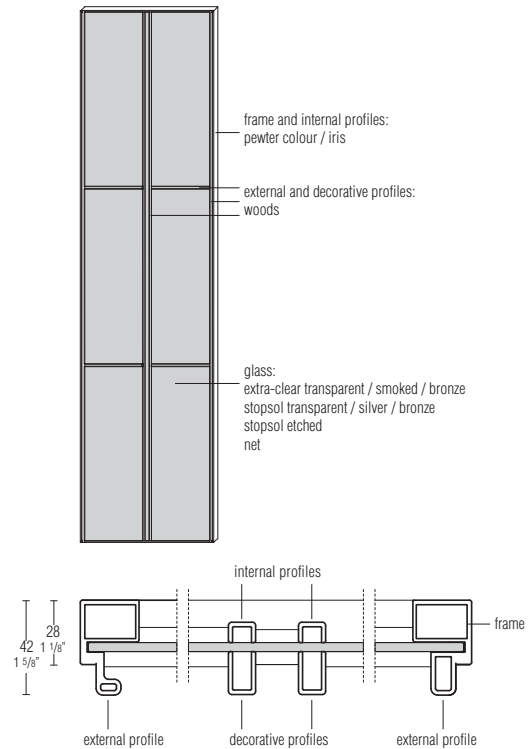

### finishes

	transparent/ smoked/bronze glass	stopsol transparent/silver/ bronze glass	stopsol etched glass	net glass	MDi by Inalco merino white / gray brown
<b>180° hinged</b>					
width 487 (19 1/8")	●	●	●	●	●
w. 651 (25 5/8")/608 (23 7/8")	●	●	●	●	●
width 815 (32 1/8") couple	●	●	●	●	●
width 979 (38 1/2") couple	●	●	●	●	●
width 1307 (51 1/2") couple	●	●	●	●	●
corner unit 1101x1101	●	●	●	●	●

### 180° hinged with profiles

width 487 (19 1/8")	●	●	●	●	
w. 651 (25 5/8")/608 (23 7/8")	●	●	●	●	
width 815 (32 1/8") couple	●	●	●	●	
width 979 (38 1/2") couple	●	●	●	●	
width 1307 (51 1/2") couple	●	●	●	●	
corner unit 1101x1101	●	●	●	●	

**LINEAR door th 25** design Vincent Van Duysen

All the doors applied to the linear modules are equipped with new generation concealed hinges on the side panel, with soft closure.  
For use on the 1101x1101 corner element, the glass doors are equipped with pivot hinges (SISTEMA 7), while the wooden doors with traditional 155° hinges.

A handle with lock is available considering a surcharge for single door or a pair (for wood and glass doors).  
The lock is not available for corners 1101x1101.

**Reductions**

The LINEAR doors can be reduced to the millimetre in height and width.

**Notes**

**LINEAR doors cannot be applied to frame or glass sides.**  
H 2889 hinged doors are available only in W 405/487.

**To match the lunar finish, we advise the side exterior finish in matt lacquered argilla and the extension profiles in the same finish as the handle.**

Molteni & C

34—  
71

**LINEAR door wood**

matt lacquer colours  
lunar

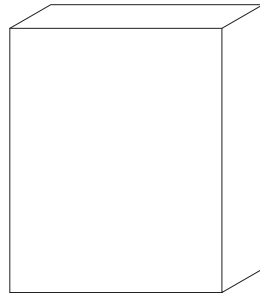

**LINEAR door 3D**

matt lacquer colours

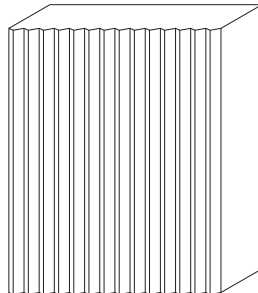

**LINEAR door glass**

extra-clear transparent glass  
smoked/bronze glass  
transparent stopsol glass  
silver stopsol glass  
bronze stopsol glass  
stopsol etched glass  
3D etched bronze

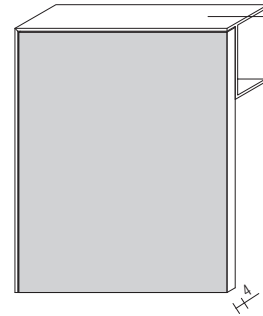

Profile finish:  
pewter colour  
bronze  
iris

**LINEAR handle**

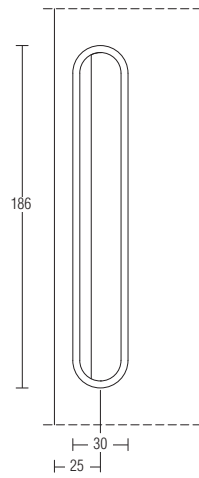

**LINEAR handle with lock**

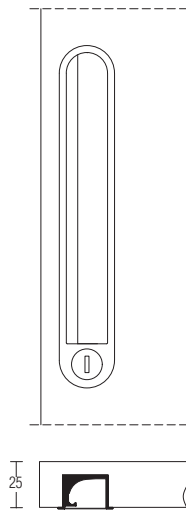

Handle finish:  
pewter colour  
bronze  
iris

**finishes**

	matt lacquer colours	lunar	3D matt lacquer colours	extra-clear transparent glass	smoked/bronze glass	transparent stopsol glass	silver stopsol glass	stopsol bronze glass	stopsol etched glass	3D etched bronze
<b>hinged doors</b>										
width 487 (19 1/8")	●	●	●	●	●	●	●	●	●	●
w. 651 (25 5/8")/608 (23 7/8")	●	●	●	●	●	●	●	●	●	●
width 815 (32 1/8")	●	●	●	●	●	●	●	●	●	●
width 979 (38 1/2")	●	●	●	●	●	●	●	●	●	●
width 1307 (51 1/2")	●	●	●	●	●	●	●	●	●	●
corner unit 1101x1101	●	●	●	●	●	●	●	●	●	●

**DATASHEET**

REGISTERED  
DESIGN

2026

**SISTEMA 7 wood doors th 35** design Vincent Van Duysen

Doors characterised by increased thickness, made in structural honeycombed panels that make the surface perfectly flat.  
 Patented folding system.  
 All doors are fitted with soft-closing mechanism.

**Notes**

Doors are not available with H 2889.

**SISTEMA 7 wood doors**

matt lacquer colours  
 glossy lacquer colours  
 wood

Molteni & C

35—  
 71

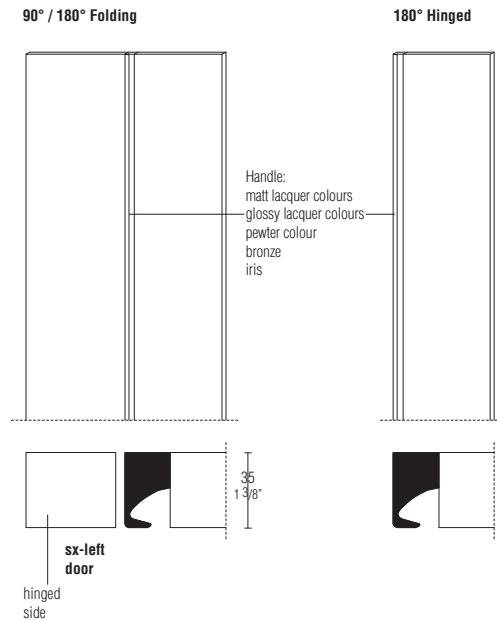

**finishes**

	matt lacquer colours	glossy lacquer colours	vertical grain wood
<b>180° Folding</b>			
width 815 (32 1/8")	●	●	●
width 979 (38 1/2")	●	●	●
corner unit 1101x1101	●	●	●
<b>90° Folding</b>			
width 815 (32 1/8")	●	●	●
width 979 (38 1/2")	●	●	●
<b>180° Hinged</b>			
width 405 (16")	●	●	●
width 487 (19 1/8")	●	●	●
w. 651 (25 5/8")/608 (23 7/8")	●	●	●
width 815 (32 1/8")	●	●	●
width 979 (38 1/2")	●	●	●
width 1307 (51 1/2")	●	●	●
corner unit 1101x1101	●	●	●

**DATASHEET**

REGISTERED  
 DESIGN

2026

## SISTEMA 7 glass doors th 35 design Vincent Van Duysen

Glass door with aluminium outer profile, th 35 mm.  
Patented folding mechanism.  
All doors are equipped with soft-closing system.

### Notes

Doors are not available with H 2889.

### Integrated lock with coded key

Hinged doors with 180° opening and 90° / 180° folding doors are available with integrated lock, considering a surcharge for single door or pair of doors.

As standard, all lockable doors in a wardrobe will have different coded keys.

On the pair of hinged doors, the lock will always be applied to the right door.

On the 90° / 180° folding doors it will be applied to the upright opposite to the handle (see section).

The lock is not applicable to hinged doors of the external corner units.

Molteni & C

### SISTEMA 7 glass doors

#### 90° / 180° Folding

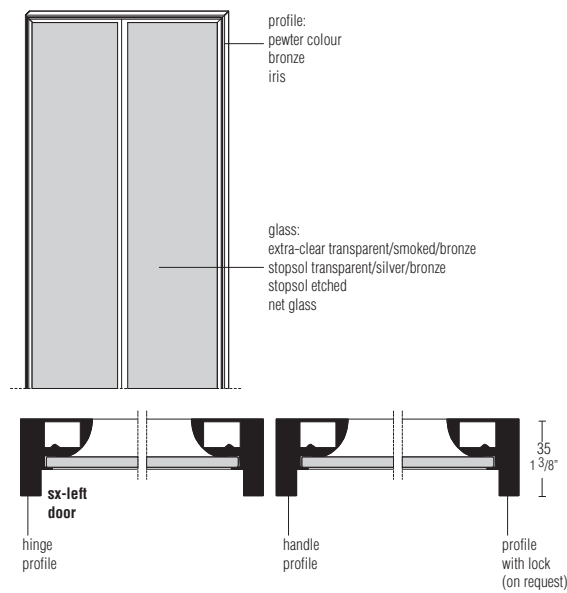

#### 180° Hinged

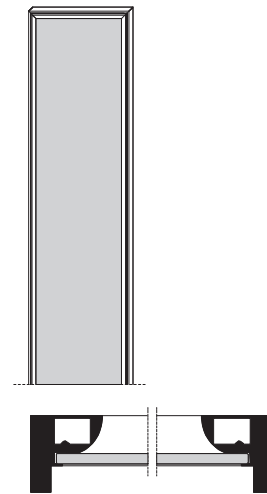

### finishes

	transparent/ smoked/ bronze glass	stopsol transparent/silver/ bronze glass	stopsol etched glass	net glass
<b>180° Folding</b>				
width 815 (32 1/8")	●	●	●	●
width 979 (38 1/2")	●	●	●	●
corner unit 1101x1101	●	●	●	●
<b>90° Folding</b>				
width 815 (32 1/8")	●	●	●	●
width 979 (38 1/2")	●	●	●	●
<b>180° Hinged</b>				
width 405 (16")	●	●	●	●
width 487 (19 1/8")	●	●	●	●
w. 651 (25 5/8")/608 (23 7/8")	●	●	●	●
width 815 (32 1/8")	●	●	●	●
width 979 (38 1/2")	●	●	●	●
width 1307 (51 1/2")	●	●	●	●
corner unit 1101x1101	●	●	●	●

### DATASHEET

REGISTERED  
DESIGN

2026

## SISTEMA 7 doors th 35

With SISTEMA 7 it is possible to create passageway solutions with doors fastened to Gliss Master wardrobe structures.  
This type of solution requires the insertion of a lid between the sides of the wardrobes.  
It can be opened thanks to a 180° folding door in wood or glass.

### Reductions

180° folding doors can be reduced in height only.

### Notes

Doors are not available with H 2889.

# Molteni & C

37—  
71

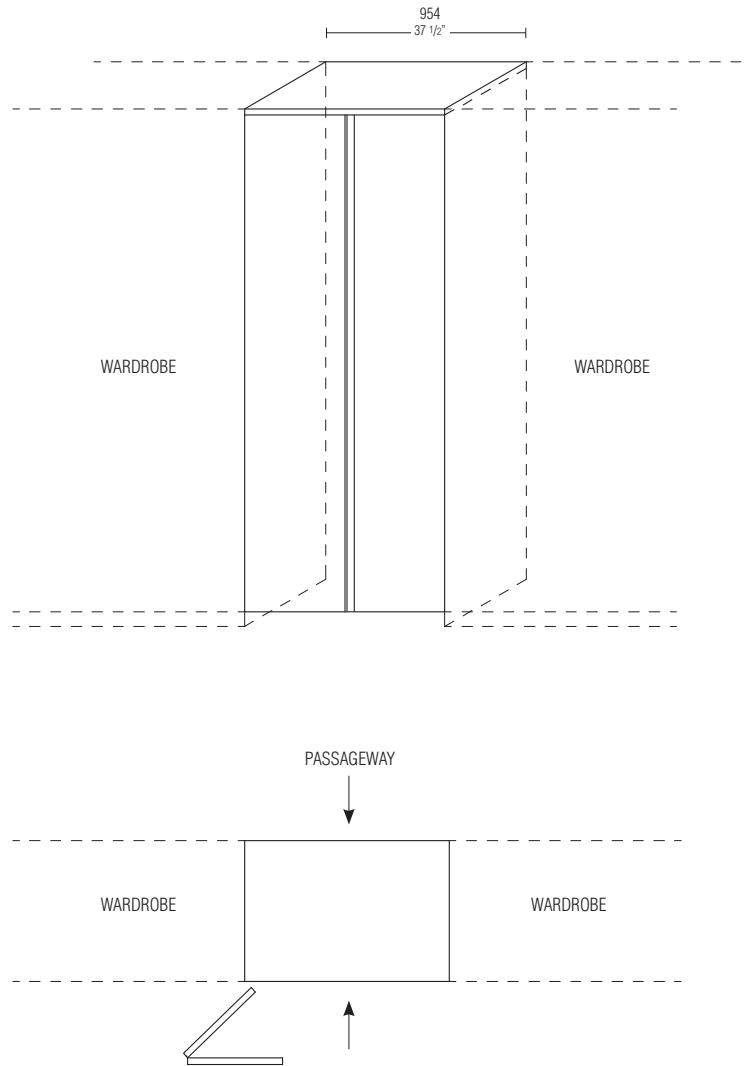

### DATASHEET

REGISTERED  
DESIGN

2026

## SPECIAL ELEMENTS

### Column with open compartment

- Can be inserted only in wardrobes without doors or with hinged doors.
- Central partitions and/or lateral pieces close the column and cannot be frame or glass.
- The open compartment is always in matt lacquered colours.
- Doors are always without handles because they protrude with respect to the structure.
- Drawers are fitted with the "E" handle of the START door.
- Front finish: melamine front, matt lacquered colours, glossy lacquered colours and wood.

\* **The price does not include the central partitions or side panels, nor the internal shelves.**

Reductions are allowed only in height, and costs of cutting the structure and doors are applied. Open compartment and lower part cannot be reduced.

Wire passage **EPA1 Ø 60** chrome on request on back.

### Notes

The back of the open compartment cannot hold a mounted TV.

# Molteni & C

38 —  
71

### Reductions

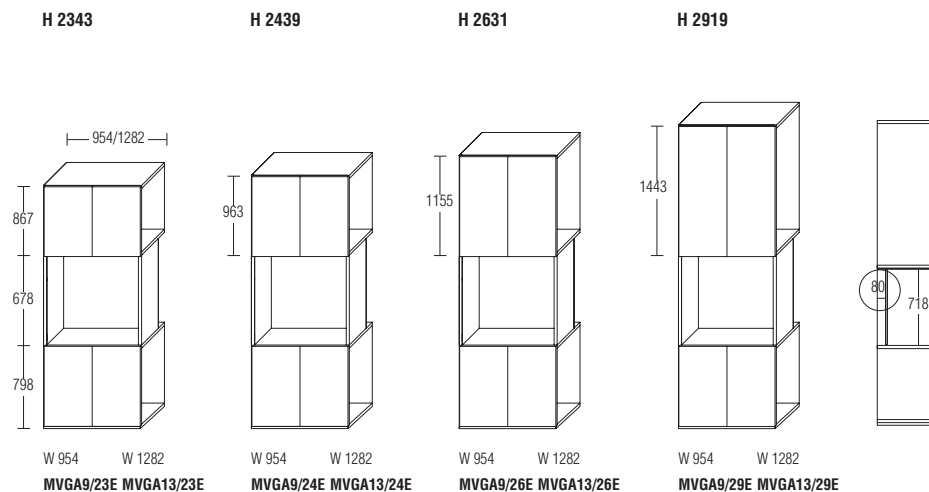
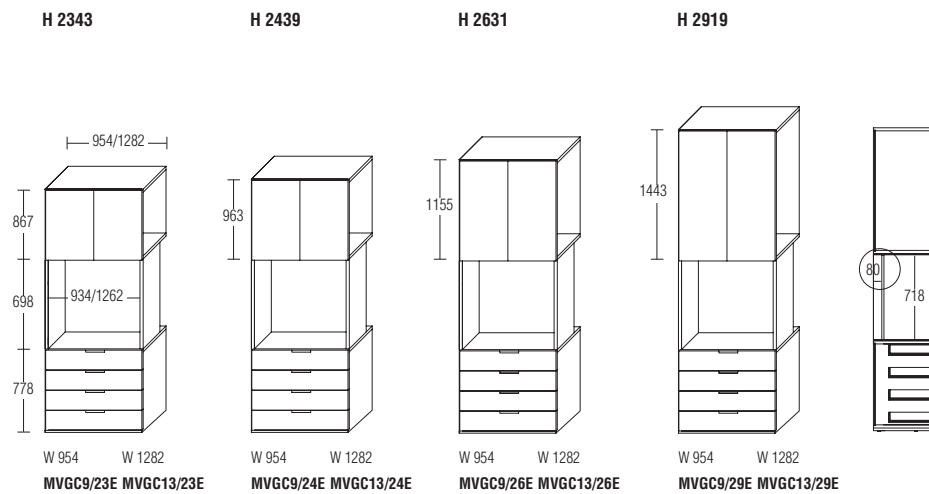

### DATASHEET

REGISTERED  
DESIGN

2026

## SPECIAL ELEMENTS

### Column with external drawers

- Can be inserted only in wardrobes with hinged doors.
- Central partitions and/or lateral pieces close the column and cannot be frame or glass.
- Pairs of doors always have only one handle mounted on the right door.
- Drawers are fitted with the "E" handle of the START door.
- Front finish: melamine front, matt lacquered colours, glossy lacquered colours and wood.

### Reductions

Reductions are allowed only in height, and costs of cutting the structure and doors are applied.

\* The price does not include the central partitions or side panels, nor the internal shelves.

# Molteni & C

39 —  
 71

### Doors with type "E" handle

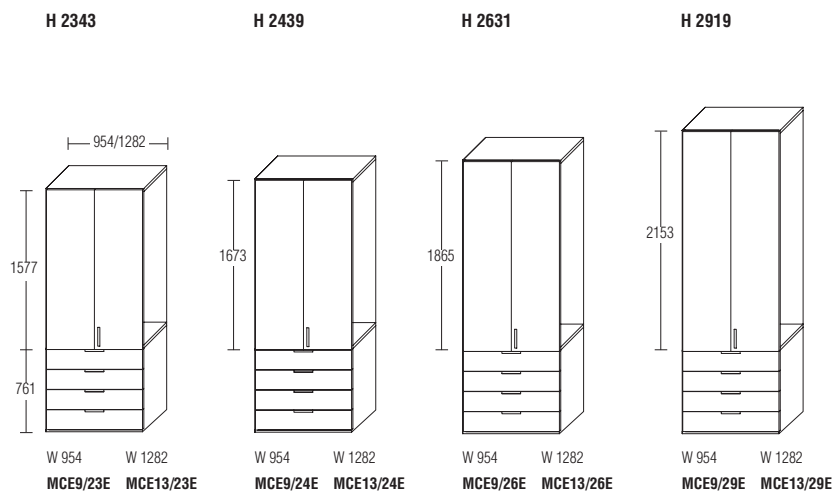

### Doors with "A FILO" handle

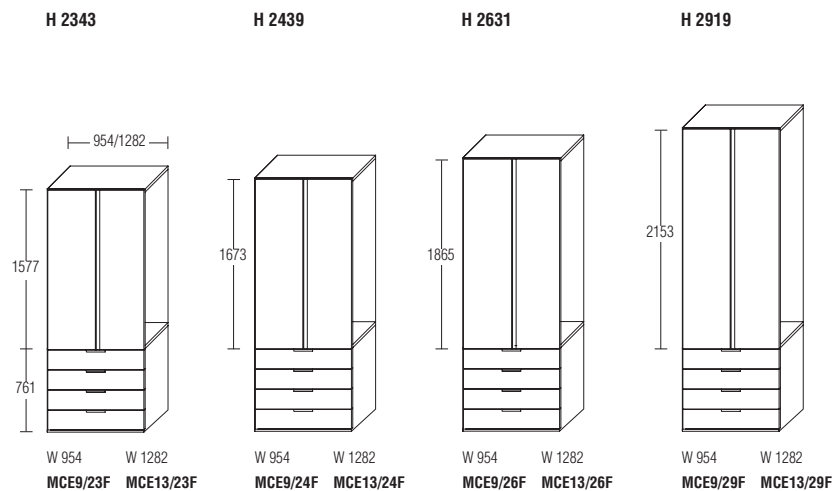

### DATASHEET

REGISTERED  
 DESIGN

2026

**BEAUTÈ** design Rodolfo Dordoni

Molteni & C

40—  
 71

finishes		eucalyptus / graphite oak / coffee oak / sunrise oak	pewter colour / bronze / iris	Eco Skin	melamine structure
<b>components</b>					
base / top	top	●			
	trim		●		
upper shelf and back mirror		●			
back panel				●	
display shelf	top			●	
	profile		●		
drawer unit structure		●			
drawer unit front	panel			●	
	profile	●			
internal drawers		●			
drawer unit top				●	
internal tray	structure	●			
	bottom			●	
end panel		●			
central panel	inside	●			
	outside				●

**Eco Skin**  
 grey  
 mink  
 hemp  
 ivory  
 dark brown  
 earth  
 arctic  
 taupe

**DATASHEET**

REGISTERED  
 DESIGN

2026



**BEAUTÉ** design Rodolfo Dordoni

**Vanity use example**

Molteni & C

41—  
71

**Side**

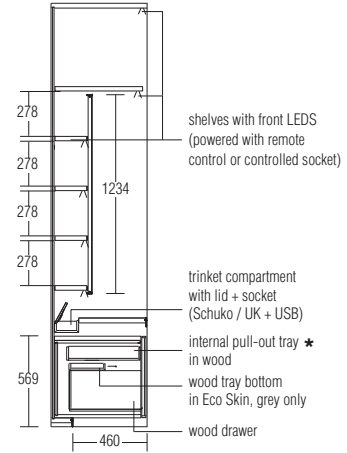
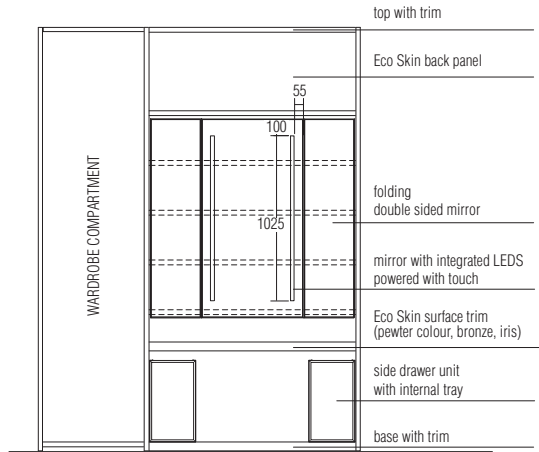

\* Insertion is possible of a tray leather (A) or two (B) (see price list page 176)

**Central**

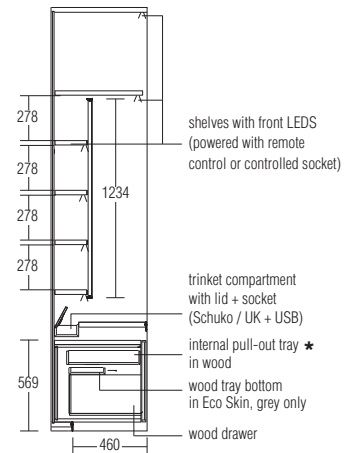
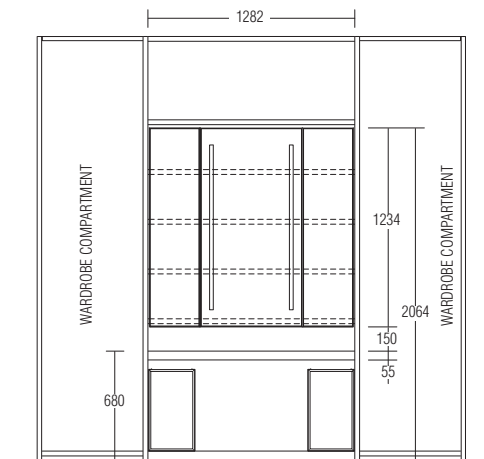

\* Insertion is possible of a tray leather (A) or two (B) (see price list page 176)

**Types of panels**

Central panel - used if the adjacent compartment has a door

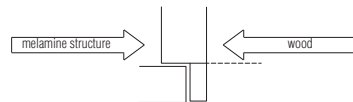

Central or end panel - used with open adjacent compartments with front profile panels or frame/glass panels

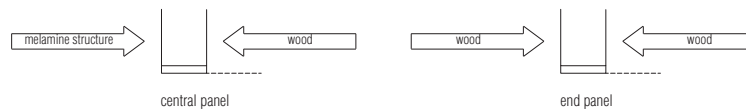

Central panel - used with open adjacent compartments with melamine structure panels

End panel - used whenever the adjacent compartments have a door or with open melamine structure panels

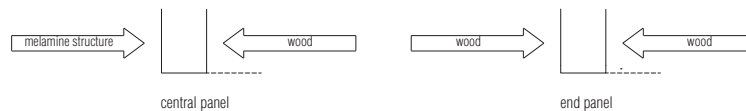

**DATASHEET**

REGISTERED  
DESIGN

2026

## FILLERS AND OPENING SIDE TRIMS

### Horizontal filler

The filler is supplied in two parts, one part to be fixed to the ceiling to which the other will be hooked on (see diagram below).

The distance of the filler from the door is the client's decision.

In the cartapaglia finish, the grain direction is always vertical.

In the wood, lunar, 3D lacquer finish, the grain is always horizontal.

### Vertical filler

The vertical filler can be placed flush with the structure or the door.

This detail must be specified in the order to prepare the side panel (see example).

If this detail is not specified when placing the order, the filler will automatically be placed flush with the structure and the side panel will have the extension profile.

### Opening fillers

Can be made with START and "A FILO" door. For handles, consider surcharge.

Always have the 155° hinges.

Are the same height as the other doors in the composition.

Have a closing strip on their lower part.

In the wood finish, the grain direction is always vertical.

42—  
 71

Horizontal filler side sections

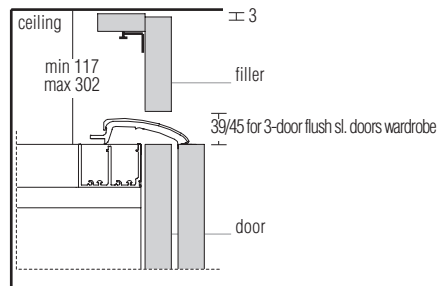
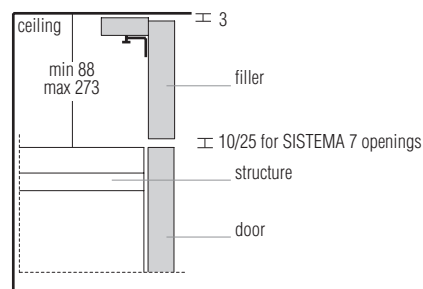

Vertical filler horizontal sections

Flush with structure

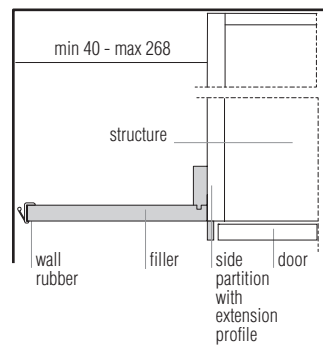

Flush with door

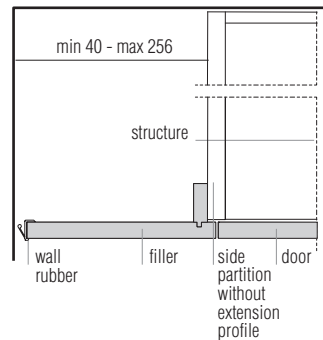

Set back

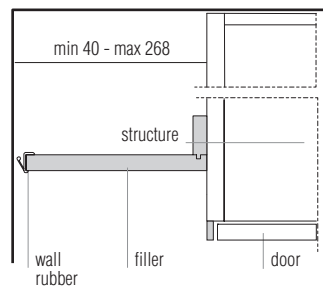

Opening filler horizontal sections

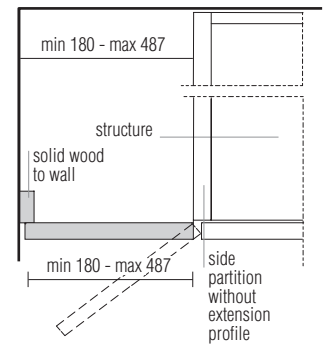

## DATASHEET

REGISTERED  
 DESIGN

2026

## LIGHTING SYSTEM

### Lighting bars with front LEDs

Internal compartments of Gliss Master wardrobes can be equipped with front LED lighting. The lighting bar can be applied to lids or to wooden, transparent glass and Eco Skin shelves, wood and glass shoe rack shelves. Using the electrified wire strip installed on the side (wood, frame or glass), the shelf can be moved. For each compartment length, we have made specific lighting bars with wiring compliant with European safety standards.

A wire strip is not needed if the compartment only has lighting on the top piece.  
**Lighting bars can be reduced with a surcharge for the shelf cutting.**

Horizontal and vertical LEDs cannot be used for the same composition.

### Notes

When placing the order, the customer must indicate how many shelves with lighting bars are required.

**For assembly: a lighting system on wardrobe with hinged doors requires a minimum extra height of 2,5 cm (1").**

**The height can be reduced to 15 mm by inspection on top cod. PAISPC01 (see page 33 price list).**

Individual wire strip is always installed on the left side panel of the compartment, with the exception of corner units for walk-in wardrobes and of the compartment next to the corner unit.









When ordering, indicate compartments with wire strip.

The electrified wire strip is mandatory for wardrobes with wooden sides and glass back.

# Molteni & C

43—  
71

### lighting bars 2700° K

W 380 2,5 watt	W 462 3 watt	W 626 4 watt	W 790 5 watt	W 954 6 watt	W 1282 8 watt	open corner element 8 watt	external corner unit 7 watt
							
EBI2C	EBI4C	EBI6C	EBI8C	EBI9C	EBI13C	EBA13C	EBB6C

### components per system

(see the diagram for component use and to calculate system cost)

### power supply unit 100W

(see the diagram for component use and to calculate system cost)

### sensor

(see the diagram for component use and to calculate system cost)

### electrified wire strip

(see the diagram for component use and to calculate system cost)

### connector (1 for 2 power supply units)

(see the diagram for component use and to calculate system cost)

### radio control kit with brightness setting (1 per power supply unit)

(see the diagram for component use and to calculate system cost)

### power supply unit block 100W with watertight box for wardrobe with glass top

(see the diagram for component use and to calculate system cost)

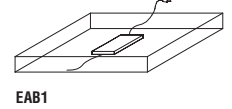
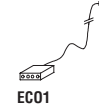
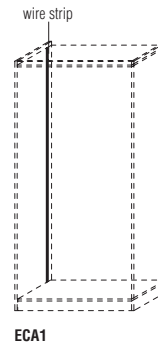
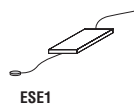
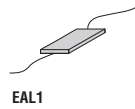

### position of bar and wire strip on wooden partitions

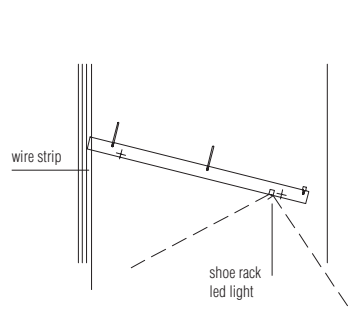
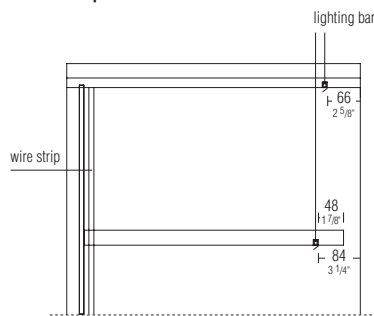

### position of bar and wire strip on glass partitions

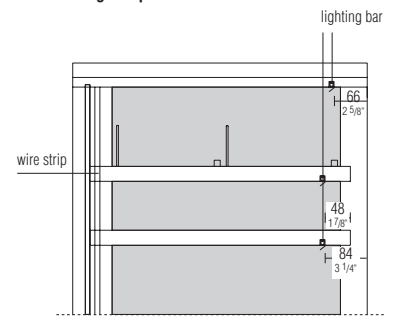

## DATASHEET

REGISTERED  
DESIGN

2026

## LIGHTING SYSTEM

### System construction diagram

A composition (wardrobe) can be equipped with more than one system and more than one power supply unit. The system with sensor must be autonomous from the system with remote controlled electrical socket.

**system type  
 with sensors  
 or remote control**

**system with sensor or remote control + channel**

**system with sensor or remote control  
 (not for use with glass backs)**

suggested for wardrobes with doors and bars positioned only on the top piece

Molteni & C

44 —

71

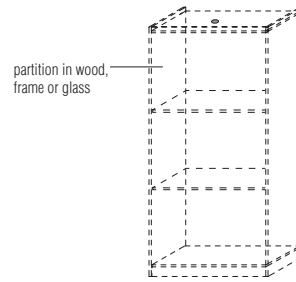
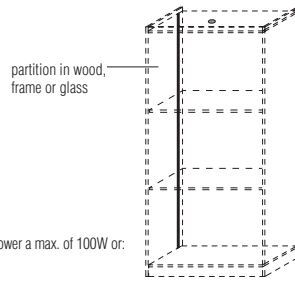

★ each power supply unit can power a max. of 100W or:  
 max 6 sensors  
 max 6 channels

power supply unit *	●	●
connector (2 power supply units max.)	●	●
wire strips on lateral pieces (1 per compartment)	●	●
sensor (1 per compartment) (optional)	●	●
radio remote control (1 per power supply unit) (optional)	●	●

### DALI kit (for DOMOTICA)

n. 1 for each power supply unit  
 cannot be used with  
 radio remote control

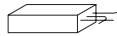

EKDA1

### DATASHEET

REGISTERED  
 DESIGN

2026

## SMART INTERNAL FITTINGS

### Clothes rails

For use only with wood shelves.  
Black finish.  
Supplementary cost for cut in width.

### Drawer units

Floor-standing or wall-mounted drawer units with drawers H 190 mm equipped with handles in black finish.  
2, 3, and 4 drawer versions cannot be modified.  
The drawer units are not stackable. In the event that requirements are different, use standard modular drawer units.  
The width of the drawer units can be reduced for a surcharge:

Molteni & C

45—  
71

### Clothes rails

### Clothes rail for corner element with doors



W 298	W 380	W 462	W 626	corner external	W 790	W 954	W 1282
PP/03	PP/02	PP/04	PP/06	PPB/06	PP/08	PP/09	PP/13



PPA/06

### Clothes rails

### Clothes rails for D 435

To mount on wooden shelves or top only with hinged door  
1 piece on compartment W 626 / 790  
2 pieces on compartment W 954 / 1282



PPQ/04

### Clothes rails for open corner element

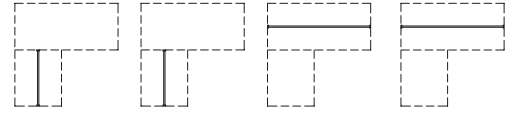

W 543  
PPA/05

W 723  
PPA/07

W 1081  
PPA/11

W 1262  
PPA/13

### Drawer units floor standing or suspended

**H 420**  
2 wooden drawers H 190



W 462	W 626	W 790	W 954	W 1282
CNT4/04PB	CNT6/04PB	CNT8/04PB	CNT9/04PB	CNT13/04PB

### Drawer units floor standing or suspended

**H 612**  
3 wooden drawers H 190



W 462	W 626	W 790	W 954	W 1282
CNT4/06PA	CNT6/06PA	CNT8/06PA	CNT9/06PA	CNT13/06PA

### Drawer units floor standing or suspended

**H 804**  
4 wooden drawers H 190



W 462	W 626	W 790	W 954	W 1282
CNT4/08PA	CNT6/08PA	CNT8/08PA	CNT9/08PA	CNT13/08PA

### "Smart" handle

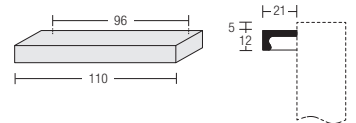

## DATASHEET

REGISTERED  
DESIGN

2026

## SMART INTERNAL FITTINGS

### Vertical Internal LED Lighting

The vertical illumination can only be used on central or lateral wooden side panels.  
Cannot be used with GLASS, SISTEMA 7 and LINEAR doors.  
Horizontal and vertical LEDs cannot be used in the same composition.  
LED bars can be reduced without a supplementary charge.

In the case of hinged doors with a lighting system, a minimum space measuring 3,5 cm in height is required. The height can be reduced to 15 mm by inspection on top cod. **PAISPC01**.

**Only 220V - Certifications C E**

Molteni & C

46—  
71

2700° K

### Vertical LED bars

H 2343  
16 watt

H 2439  
17 watt

H 2631  
18 watt

H 2919  
20 watt

### Side section with position



EVBA23



EVBA24



EVBA26



EVBA29

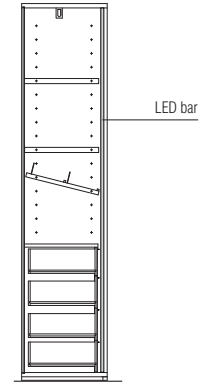

### Specific components for systems with vertical LEDs

**Power supply units**  
50 watt, 75 watt, 100 watt

### Sensor

**Connector**  
(1 for power supply unit)

**Remote control with dimmer**  
1 per power supply unit

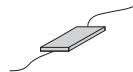

EVAL050

EVAL075

EVAL100



EVSE1



EVCO1



EVRA1

### Diagram of LED lighting system

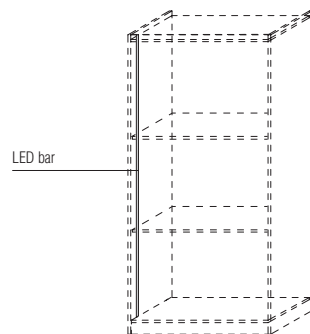

### Components

- LED bar, 1 or 2 per compartment
- power supply unit, 1 or 2 per wardrobe depending on total wattage
- connector, 1 per power supply unit
- optional remote control, in the absence of a controlled socket
- optional sensor, in the absence of a controlled socket

### DATASHEET

REGISTERED  
DESIGN

2026

## INTERNAL ACCESSORIES

Aircub is an air purifier and aroma diffuser that eliminates up to 95% of the harmful agents inside wardrobes through a process of ionisation and ozonation. Aircub can be installed on the back panel of each compartment. Just plug it into the electrical socket and turn it on. Every Aircub has a single plug. Up to 3 Aircubs per wardrobe can be installed using the specific multi-socket connector.

Information about Aircub is available on the website <https://www.puricraft.com>  
Not available for USA market.

# Molteni & C

47—

71

**Aircub - air purifier**  
W 270 D 28 H 120  
W 10 5/8" D 1 1/8" H 4 3/4"  
(cable length L3m)

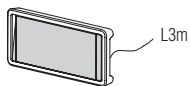

EAC1

### product advdoorges

- improves air quality
  - reduces bacteria that cause foul odours
  - prevents mould and mites from forming
  - dispenses fragrance
  - does not have filters that require maintenance or changes
  - includes n.1 fragrance pod
- Scented wafers can be ordered online:  
<https://www.puricraft.com>

**multi-socket connector**  
cable length 3m  
W 250 D 60 H 40  
W 9 7/8" D 2 3/8" H 1 5/8"

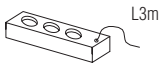

EAC2

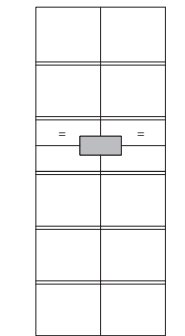
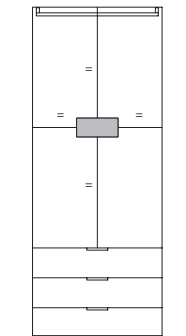

**For correct function it is advisable  
to position the Aircub at the centre  
of the compartment**

## DATASHEET

REGISTERED  
DESIGN

2026

**INTERNAL FITTINGS**

**Internal fittings with wooden sides**

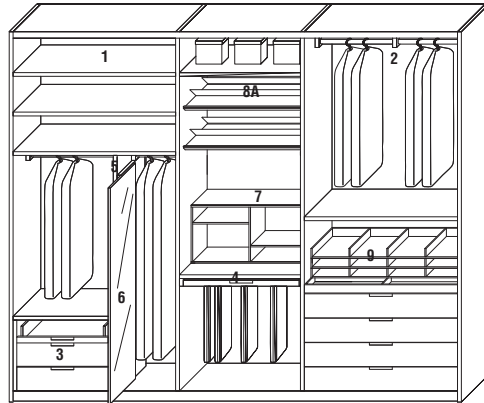

**Internal fittings with frame or glass sides**

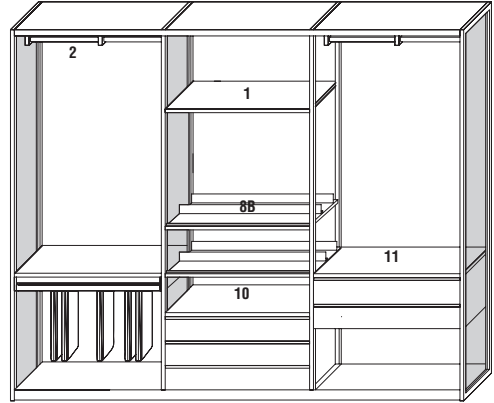

- 1** Shelf th 30 mm (wood, glass, Eco Skin)
- 2** Clothes rail
- 3** Modular drawer unit only for wooden sides and backs
- 4** Trouser holder
- 5** Central divider piece th mm 30 only for compart. with wooden sides and backs
- 6** Swivel pull-out mirror only for compart. with wooden sides and backs
- 7** Sweater and shirt holder module only for wooden sides and back panels
- 8A** Inclined shoe rack shelf only for wooden sides and backs
- 8B** Horizontal shoe rack shelf only for frame sides, glass sides or glass back
- 9** Pull-out shirt holder only for wooden sides and backs
- 10** Floor standing drawer unit only for compart. with frame or glass sides
- 11** Suspended drawer unit only for compart. with frame or glass sides

**Section of internal fittings**

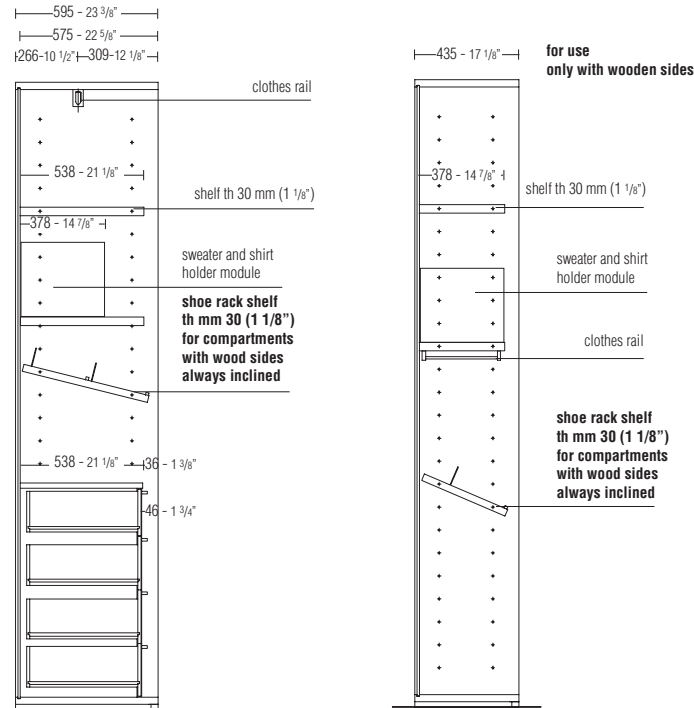

**DATASHEET**

REGISTERED  
DESIGN

2026



## SOFT LINE INTERNAL FITTINGS

- ▶ The SOFT LINE equipment can be used in units with frame, glass and wooden side panels and with all types of backs.
- ▶ In case of application on the glass/frame side panels, the special metal profiles PST/PSV must be used. These are not included in the price of the trays.
- ▶ The pull-out frames of the SOFT LINE equipment cannot be combined with modular drawer units.
- ▶ **No reductions of any kind are possible.**

### Notes

- The SOFT LINE equipment should not be used:
- in corner units
  - in units close to corner elements in wardrobes with doors
  - in units closed by overlapping sliding doors.

Molteni & C

49—  
 71

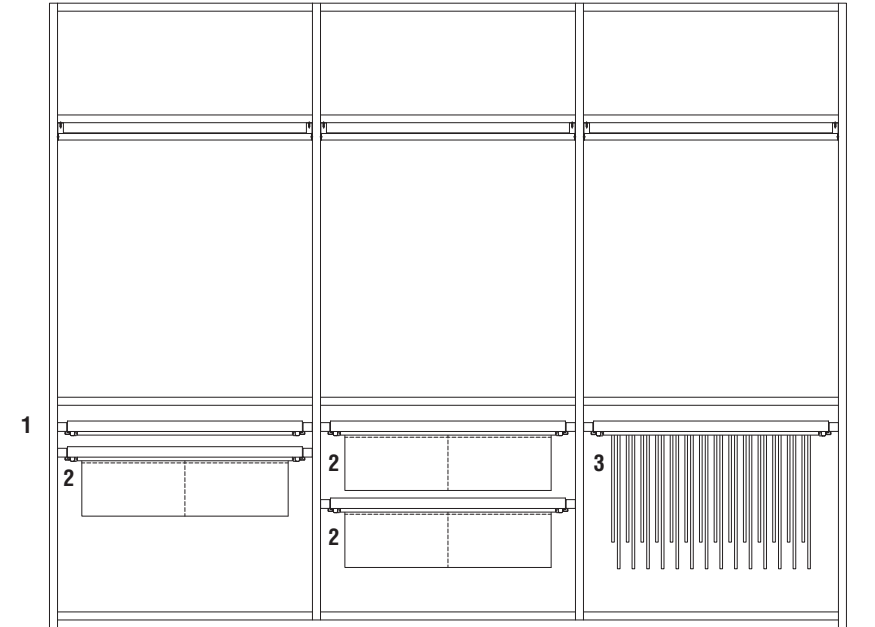

- 1 Pull-out frame with Eco Skin bottom / with Eco Skin bottom and internal grid
- 2 Pull-out frame with Eco Skin sack
- 3 Trouser holder pull-out frame

The positioning of the pull-out frames is always at 96 mm intervals (see example)

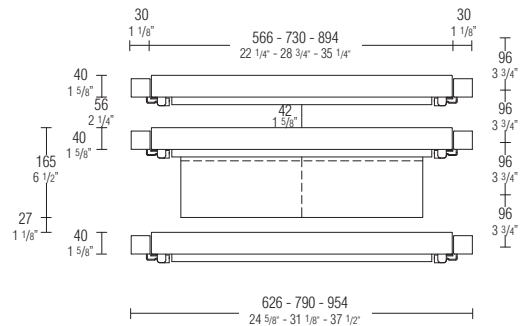
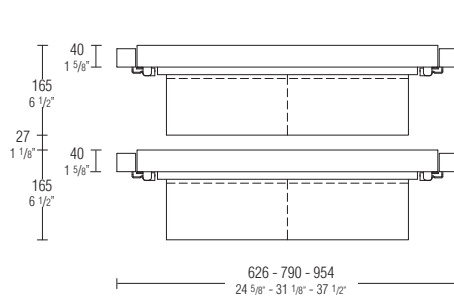

### DATASHEET

REGISTERED  
 DESIGN

2026

**SOFT LINE INTERNAL FITTINGS**

**Finishes of pull-out frame, internal grid and trouser holder bars**

bronze  
 pewter colour  
 iris

**Finishes of bottoms and Eco Skin sack**

grey  
 mink  
 hemp  
 ivory  
 dark brown  
 earth  
 arctic  
 taupe

**Molteni & C**

**50**—  
 71

**Pull-out frame with Eco Skin bottom**

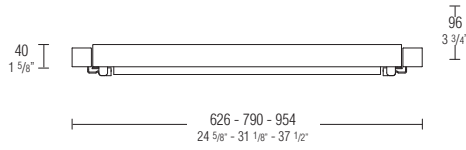

**Pull-out frame with Eco Skin bottom and internal grid**

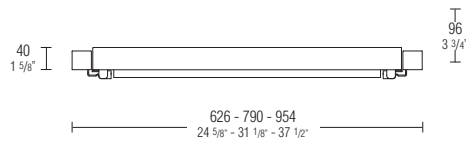

**Internal aluminium grid th 5 mm**

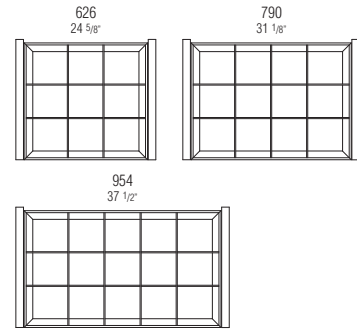

**Trouser holder pull-out frame**

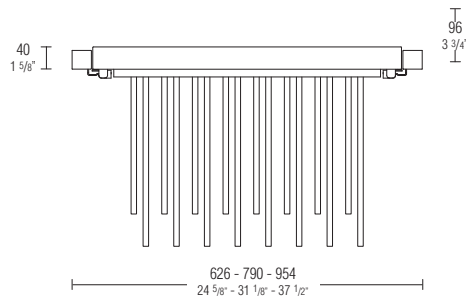

W 626 : max **8** bars  
 W 790 : max **11** bars  
 W 954 : max **14** bars

**Pull-out frame with Eco Skin sack**

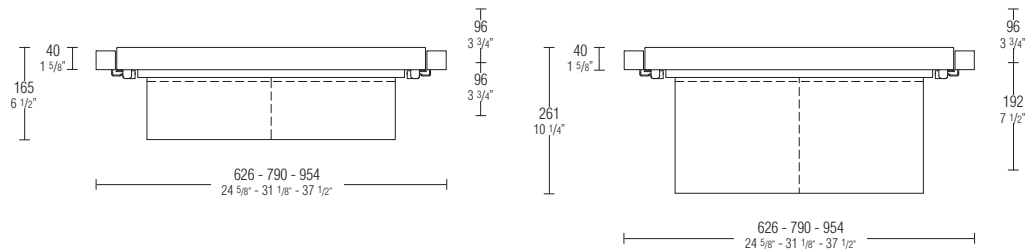

**DATASHEET**

REGISTERED  
 DESIGN

2026

## INTERNAL FITTINGS

### wood shelves - top shelves (only D 538)

D 538 th 30  
D 378 th 30

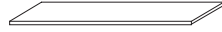

W 298	W 380	W 462	W 626	W 790	W 954	W 1282
<b>RI/3</b>	<b>RI/2</b>	<b>RI/4</b>	<b>RI/6</b>	<b>RI/8</b>	<b>RI/9</b>	<b>RI/13</b>

### shelf for external corner unit th 30

559x559  
**RIB/6**

### shelf for open corner element th 30

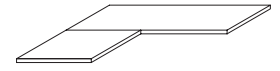

1081x1081  
**RIA/11**

1262x1262  
**RIA/13**

glass shelves can be fitted with front LED light bars and comply with the wiring standards specified on pages 140/141 price list

### transparent glass shelves

D 538 th 30  
D 378 th 30



W 380	W 462	W 626	W 790	W 954	W 1282
<b>RV/2</b>	<b>RV/4</b>	<b>RV/6</b>	<b>RV/8</b>	<b>RV/9</b>	<b>RV/13</b>

not for use in compartments adjacent to the corner element in wardrobes with doors

### shelf for external corner unit th 30

559x559  
**RVB/6**

Molteni & C

51—  
71

Eco Skin shelves can be fitted with front LED light bars and comply with the wiring standards specified on pages 140/141 price list

### Eco Skin shelves - shelves with Eco Skin cover (only D 538)

D 538 th 30  
D 378 th 30

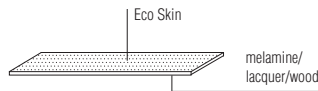

W 298	W 380	W 462	W 626	W 790	W 954	W 1282
<b>RE/3</b>	<b>RE/2</b>	<b>RE/4</b>	<b>RE/6</b>	<b>RE/8</b>	<b>RE/9</b>	<b>RE/13</b>

### shelf for external corner unit th 30

559x559  
**REB/6**

### Eco Skin shelf for open corner element th 30

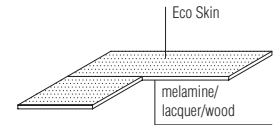

1081x1081  
**REA/11**

1262x1262  
**REA/13**

When ordering, specify the finish Eco Skin and profile

### terminal element shelf W 462 D 365/533 th 30



**RIT/4**

### corner shelf W 622 D 622 th 30

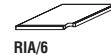

**RIA/6**

### metal profile for shelves beside the corner but not adjacent to shelves RIA/6

**PSA**

mandatory to cover drawer units W 1282 with single drawer

### reinforced shelves D 538 th 30

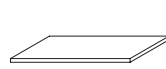

top  
W 1282  
**RR/13**

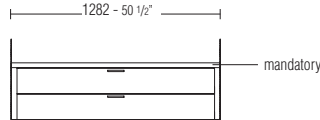

### reinforced Eco Skin shelves pewter colour, bronze or iris front profile D 538 th 30

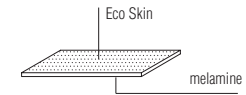

top  
W 1282  
**RRE/13**

### Shoe rack shelves

Shoe rack shelves can be used with wood sides and with frame or glass sides. When inserted between wood sides, this part will always be inclined (example 1). When there are frame or glass sides, this part will always be horizontal (example 2).

### Notes

To hook to the frame or glass sides, add the price of the relative metal profiles.

#### example 1

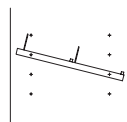

### shoe rack shelves D 538 th 30



W 462	W 626	W 790	W 954	W 1282
<b>RSP/4</b>	<b>RSP/6</b>	<b>RSP/8</b>	<b>RSP/9</b>	<b>RSP/13</b>

#### example 2

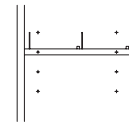

#### example 1

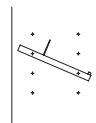

### shoe rack shelves D 368 th 30



W 462	W 626	W 790	W 954	W 1282
<b>RQP/4</b>	<b>RQP/6</b>	<b>RQP/8</b>	<b>RQP/9</b>	<b>RQP/13</b>

### metal profile for attaching shelves to frame side



**PST**

### metal profile for attaching shelves to glass side



**PSV**

### metal profile for attaching shelves with LEDs to frame side (always on the left, except in corner shelves)



**PSE**

### DATASHEET

REGISTERED  
DESIGN

2026

## INTERNAL FITTINGS

Molteni & C

52—  
71

### clothes rails

W 298	W 380	W 462	W 626	for external corner unit	W 790	W 954	W 1282
PO/3	PO/2	PO/4	PO/6	POB/6	PO/8	PO/9	PO/13

### clothes rail for corner compartment with doors

POA/6
-------

### clothes rail for D 435

to mount on wood shelves or  
top only with hinged doors

nr. 1 piece on compartment W 626/790  
nr. 2 pieces on compartment W 954/1282



POQ/4

### clothes rails for open corner compartment

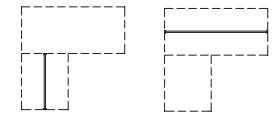

W 543  
W 723

POA/5  
POA/7

W 1081  
W 1262

POA/11  
POA/13

### pull-out coat hanger rail

for melamine shelf (without profile) th 30



OP7

### hanger W 450

beech stained grey  
(package of 10 pieces)



OP10

### hanger with clips W 450

beech stained grey  
(package of 3 pieces)



OP11

Maximum  
load-bearing capacity  
10 kg

### pull-down hanger

H mm 1040  
for compart. W 626

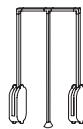

SER/6

for compart. W 790

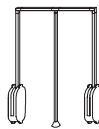

SER/8

for compart. W 954

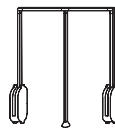

SER/9

for compart. W 1282

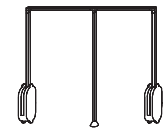

SER/13

When ordering, specify  
the finish of the front profile:  
pewter colour, bronze or iris

### floor standing central divider pieces

D 538 th 30

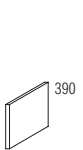

SDT/04

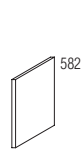

SDT/05

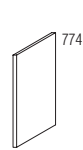

SDT/07

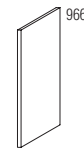

SDT/09

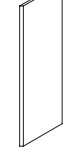

SDT/11

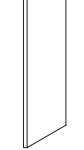

SDT/13

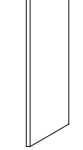

SDT/15

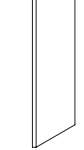

SDT/17

### Glass shoe rack shelves

Shoe rack shelves in glass can be used only with wood sides.

### Notes

No reductions of any kind are possible.

### glass shoe rack shelves

D 520 th 30

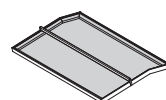
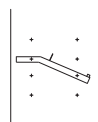

W 790  
RSW/8

W 954  
RSW/9

W 1282  
RSW/13

DATASHEET

REGISTERED  
DESIGN

2026

Dimensions in millimeters and inches. The right to discontinue and make changes is reserved. This information is based on the latest product information available at the time of printing.

## GLASS LID FOR CHEST OF DRAWERS

### To be used only in compartments with wooden sides

Modular chests of drawers can be made with a transparent glass lid in the module widths 790/954/1282.

It is mandatory that the first drawer be H 190 in wood (special measure).

The top can be fitted with a LED lighting bar, but it cannot be connected to the cable holder.

The connection to the power cord has to pass behind the back panel.

Grey Eco Skin bottoms and saffiano grey melamine dividers can be inserted into the 1st drawer.

**Lid profiles**  
 bronze  
 pewter colour  
 iris

Molteni & C

53—  
 71



W 790  
**CSV/08**

W 954  
**CSV/09**

W 1282  
**CSV/13**

### Example of use

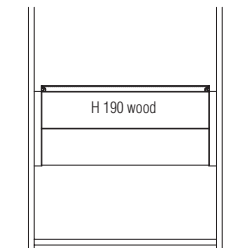

### dividers for 1st drawer with glass cover H 190

also usable with  
 Eco Skin bottom

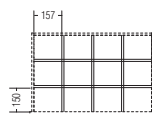

for drawer W 716  
**CED18V**

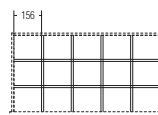

for drawer W 880  
**CED19V**

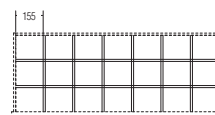

for drawer W 1208  
**CED113V**

### Eco Skin bottoms for drawers

D 473 for 1st drawer with glass cover



W 664  
**CEQ/F8V**

W 828  
**CEQ/F9V**

W 1156  
**CEQ/F13V**

DATASHEET

REGISTERED  
 DESIGN

2026

[moltenigroup.com](http://moltenigroup.com)

Dimensions in millimeters and inches. The right to discontinue and make changes is reserved. This information is based on the latest product information available at the time of printing.

**INTERNAL FITTINGS**

**Internal fittings - sweater and shirt holder module, watch charger and cloth boxes**

Fixed elements to be used resting on shelves or chests of drawers.

In the compartments indicated with ■ it is possible to insert the Swisskubik Masterbox automatic watch winding devices (rotors).

**sweater and shirt holder module**

W 625 D 378 H 354

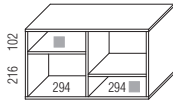

**■ BG06/03/1**

W 789 D 378 H 354

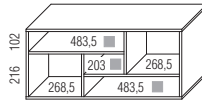

**■ BG08/03/1**

**sweater and shirt holder module**

W 953 D 378 H 354

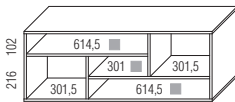

**■ BG09/03/1**

W 1281 D 378 H 354

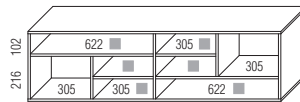

**■ BG013/03/1**

**watch winder  
 Masterbox of Swisskubik**

W 100 D 100 H 100



**BGC01**

**canvas-covered boxes  
 with Molteni logo**

**W 500 D 400 H 150**  
 (package of 2 pieces)

**W 500 D 400 H 300**  
 (package of 2 pieces)



**CES1**



**CES2**

**INTERNAL FITTINGS**

**Procedure for using the swivel pull-out mirror**

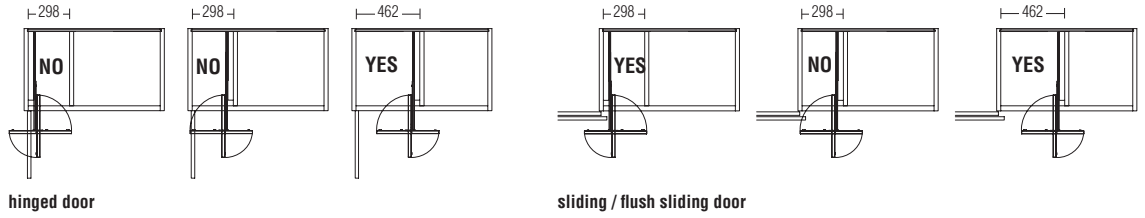

**Molteni & C**

55—  
 71

**mirror**  
 applied to inside of  
 hinged door  
 W 315 H 1600 th 4

**swivel pull-out mirror**  
 to be applied onto the side,  
 partition or central divider pieces  
 D 555 H 1443 th 90



**SPECH**

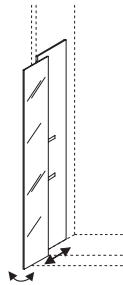

**SPECS/17**

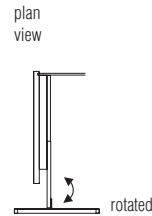

rotated

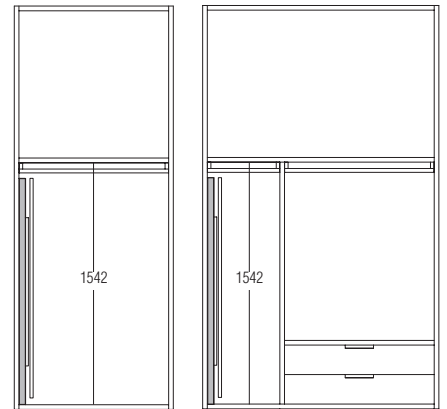

**DATASHEET**

REGISTERED  
 DESIGN

2026

## CAVE handle

### Internal fittings - modular drawers and trays

#### Notes

The parts of this internal fittings are produced with width and height dimensions corresponding to the modular compartments. This makes it possible to organise the internal spaces in a number of ways. To correctly and quickly determine the internal fittings, some of the possible compositions are in the following pages.

**When ordering, specify the handle finish as pewter colour, bronze or iris.**

For the CAVE handle covered in Eco Skin, add a supplementary charge each

**No reductions of any kind can be made on drawers, trays and pairs of side panels.**

The pairs of side panels p. 151 price list or structures p. 152 price list are necessary for inserting all the elements. Compositions must be completed with an upper shelf (p. 131 price list) or glass cover p. 137 price list.

**Warnings on using compartments adjacent to the corner element**  
It is impossible to use trouser or trinket trays (used individually).

#### Wood and open drawer finishes

Front:

- melamine structure
- piqué
- matt lacquer colours
- wood

Inside:

- saffiano grey melamine

# Molteni & C

### Items available

#### Wooden drawers

#### Open drawers only lower handle

Handle finishes:  
pewter colour  
bronze  
iris

#### Upper handle

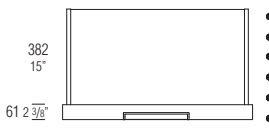
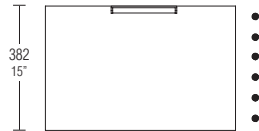
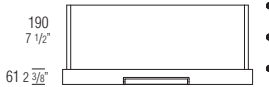
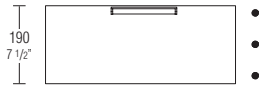

416 - 580 - 716 - 880 - 1208  
16 3/8 - 22 7/8 - 28 1/4 - 34 5/8 - 47 1/2

416 - 580 - 716 - 880 - 1208  
16 3/8 - 22 7/8 - 28 1/4 - 34 5/8 - 47 1/2

#### Lower handle



416 - 580 - 716 - 880 - 1208  
16 3/8 - 22 7/8 - 28 1/4 - 34 5/8 - 47 1/2

DATASHEET

REGISTERED  
DESIGN

2026



**CAVE handle**

**Trouser holder/laundry sack tray finishes**

- Front:  
 - melamine structure  
 - piqué  
 - matt lacquer colours  
 - wood  
 Internal frame:  
 - saffiano grey melamine with trouser rods  
 painted in textured saffiano grey

- Laundry sack:  
 - natural ecru cotton

**Trinket tray finishes**

- Front:  
 - melamine structure  
 - piqué  
 - matt lacquer colours  
 - wood  
 Internal frame, bottom, and grid:  
 - saffiano grey melamine

**Pull-out shelf finishes**

- Front:  
 - melamine structure  
 - piqué  
 - matt lacquer colours  
 - wood  
 Surface and back:  
 - saffiano grey melamine

**Molteni & C**

57—  
 71

**Trouser holder  
 only upper handle**

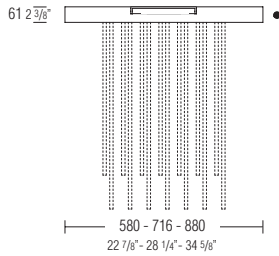

N.B.: usable only with suspended side panels  
 as the bottom piece

**Trinket trays (tie and belt)  
 with internal grid  
 only upper handle**

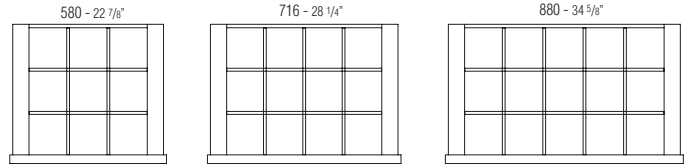
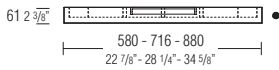

internal tray dividers

**Pull-out trays  
 only lower handle**

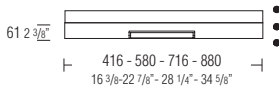

**Tray laundry sack  
 only upper handle**

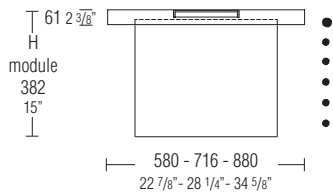

if the tray is  
 suspended  
 as a lower element  
 consider (●)

**DATASHEET**

REGISTERED  
 DESIGN

2026

## HOLD handle

### Internal fittings - modular drawers and trays

#### Notes

The parts of this internal fittings are produced with width and height dimensions corresponding to the modular compartments. This makes it possible to organise the internal spaces in a number of ways. To correctly and quickly determine the internal fittings, some of the possible compositions are in the following pages.

The pairs of side panels p. 151 price list or structures p. 152 price list are necessary for inserting all the elements. Compositions must be completed with an upper shelf (p. 131 price list) or glass cover p. 137 price list.

When ordering, specify the handle finish as pewter colour, bronze or iris.

**No reductions of any kind can be made on drawers, trays and pairs of side panels.**

#### Warnings on using compartments adjacent to the corner element

It is impossible to use trouser or trinket trays (used individually).

#### Wood drawer finishes

- Front:
- melamine structure
  - piqué
  - matt lacquer colours
  - wood
  - fine grain with pewter colour, bronze or iris profile
  - BLEND fabric with pewter colour, bronze or iris profile
- Inside:
- saffiano grey melamine

#### Glass drawer finishes

- Front:
- transparent glass with pewter colour, bronze or iris frame
- Inside:
- saffiano grey melamine

#### Open drawer finishes

- Front:
- melamine structure
  - piqué
  - matt lacquer colours
  - wood
- Inside:
- saffiano grey melamine

Molteni & C

58 —

71

### Items available

#### Wooden drawers

#### HOLD handle (pewter colour, bronze or iris finish)



416 - 580 - 716 - 880 - 1208  
 16 3/8 - 22 7/8 - 28 1/4 - 34 5/8 - 47 1/2

#### Glass drawers



416 - 580 - 716 - 880 - 1208  
 16 3/8 - 22 7/8 - 28 1/4 - 34 5/8 - 47 1/2

#### Open drawers

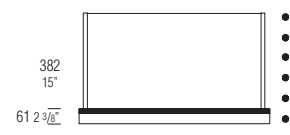
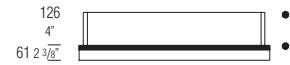

416 - 580 - 716 - 880 - 1208  
 16 3/8 - 22 7/8 - 28 1/4 - 34 5/8 - 47 1/2

### DATASHEET

REGISTERED  
 DESIGN

2026

**HOLD handle**

**Trouser holder/laundry sack tray finishes**

Front with pewter colour, bronze or iris profile:  
 - melamine structure  
 - piqué  
 - matt lacquer colours  
 - wood  
 - fine grain  
 - BLEND fabric  
 Internal frame:  
 - saffiano grey melamine with trouser rods  
 painted in textured saffiano grey

Laundry sack:  
 - natural ecru cotton

**Trinket tray finishes**

Front with pewter colour, bronze or iris profile:  
 - melamine structure  
 - piqué  
 - matt lacquer colours  
 - wood  
 - fine grain  
 - BLEND fabric  
 Internal frame, bottom, and grid:  
 - saffiano grey melamine

**Pull-out shelves finishes**

Front:  
 - melamine structure  
 - piqué  
 - matt lacquer colours  
 - wood  
 Surface and back:  
 - saffiano grey melamine

**HOLD handle  
 (pewter colour, bronze  
 or iris finish)**



**Trouser holder**

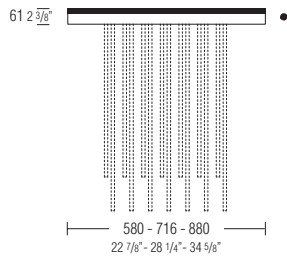

N.B.: usable only with suspended side panels  
 as the bottom piece

**Trinket trays (tie and belt)  
 with internal grid**

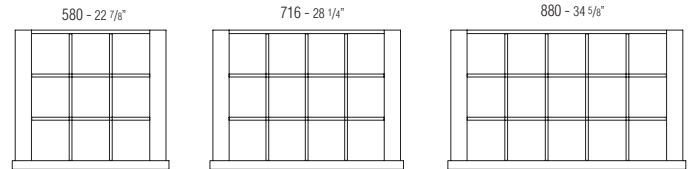
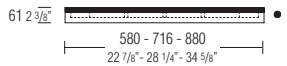

internal tray dividers

**Pull-out trays**

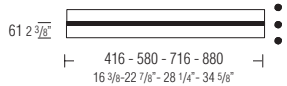

**Tray  
 laundry sack**

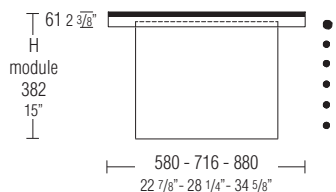

if the tray is  
 suspended  
 as a lower element  
 consider (●)

**DATASHEET**

REGISTERED  
 DESIGN

2026

**EXAMPLES OF COMPOSITE DRAWER UNITS WITH CAVE HANDLE**

Melamine faced drawers have upper and lower handles.  
 Trouser holder and trinket trays always have an upper handle;  
 pull-out trays and open drawers always have a lower handle.

Molteni & C

**Melamine drawers**  
**H 126/190/382**

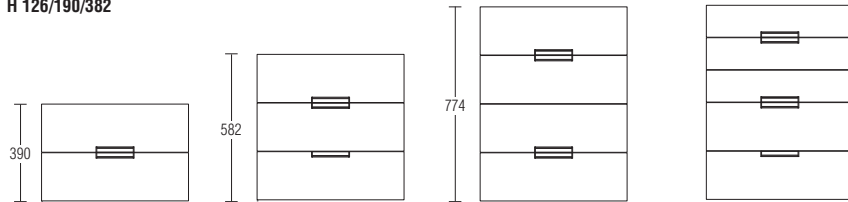

**Trouser holders/trinket trays/laundry sack tray**

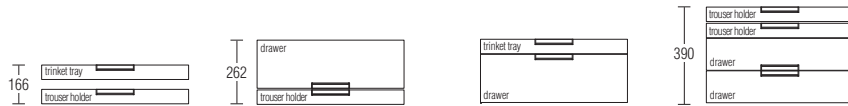

**Pull-out trays**

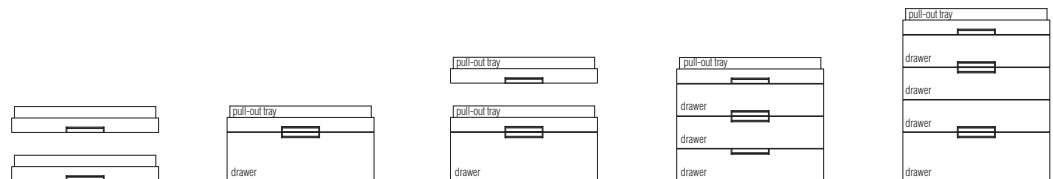

**Open drawers**

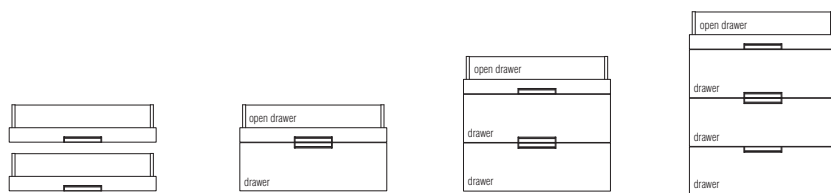

## INTERNAL FITTINGS - ACCESSORIES FOR DRAWERS

### Leather trays

Handmade leather trays with Alcantara bottom.  
The version for men is brown (cat. P col. D533),  
The version for women is powder pink (cat. P col. D524).

### Eco Skin bottoms

Made with grey coloured Eco Skin.

Molteni & C

61 —  
71

### leather trays men's drawers

W 206 D 430 H 58 (A)  
W 206 D 215 H 58 (B)

watch holder  
(A)

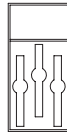

CEV/MA1

watch/  
bracelet holder  
(A)

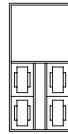

CEV/MA2

jewellery holder  
with movable dividers  
(B)



CEV/MB1

complete men's  
drawer offer



CVM1

### leather trays women's drawers

W 206 D 430 H 58 (A)  
W 206 D 215 H 58 (B)

watch holder  
(A)

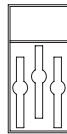

CEV/WA1

watch/  
bracelet holder  
(A)

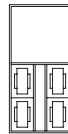

CEV/WA2

jewellery holder  
with movable dividers  
(B)



CEV/WB1

ring holder  
(B)



CEV/WB2

earring holder  
(B)



CEV/WB3

complete women's  
drawer offer

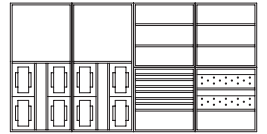

CVW1

### Modularity drawings for inserting trays into drawers

drawer W 416

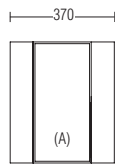

1 tray (A)  
or 2 trays (B)

drawer W 580

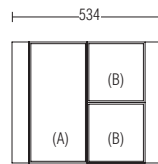

2 trays (A)  
or 4 trays (B)

drawer W 716

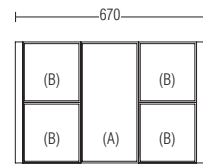

3 trays (A)  
or 6 trays (B)

drawer W 880

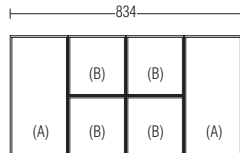

4 trays (A)  
or 8 trays (B)

drawer W 1208

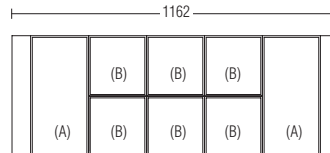

5 trays (A)  
or 10 trays (B)

### Eco Skin bottoms for drawers D 432



W 366

CEQ/F4

W 530

CEQ/F6

W 666

CEQ/F8

W 830

CEQ/F9

W 1158

CEQ/F13

### DATASHEET

REGISTERED  
DESIGN

2026

## ISLAND WITH GLASS TOP

### Island with glass top

#### Island finishes

silver cembran  
 sunrise chestnut  
 light chestnut  
 dark chestnut  
 matt lacquer colours in the Molteni colour range

#### Handles / top profile finishes

pewter colour  
 bronze  
 iris

#### No reductions of any kind are possible

For the CAVE handle covered in Eco Skin, add a supplementary charge each.

#### Notes

The divider grids are specific for upper drawers.  
 If dividers are desired in the other drawers,  
 use those shown on pages 157/160 of the price list.

Molteni & C

62—  
 71

**island with glass top**  
 W 1272 D 1022 H 864  
 W 50 1/8" D 40 1/4" H 34"

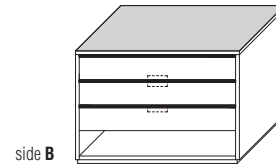
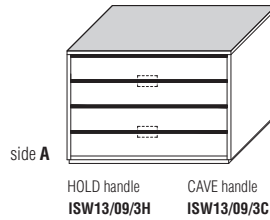

**island with glass top**  
 W 1498 D 1022 H 864  
 W 59" D 40 1/4" H 34"

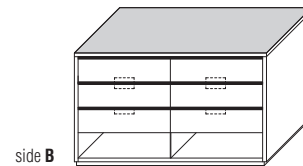
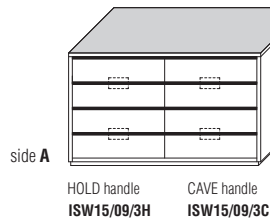

#### accessories for upper drawer

#### partition grid

grey saffiano  
 W 666 D 443 W 1158 D 443  
 W 26 1/4" D 17 1/2" W 45 5/8" D 17 1/2"

#### Eco Skin bottom

grey  
 W 664 D 443 W 1156 D 443  
 W 26 1/8" D 17 1/2" W 45 1/2" D 17 1/2"

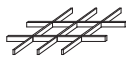

CEGD/28



CEGD/33

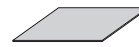

CEQ/F28



CEQ/F33

#### DATASHEET

REGISTERED  
 DESIGN

2026

## GLISS MASTER — Island and modular drawer unit VINCENT VAN DUYSSEN 2025

63 —  
71



The system of modular island and drawer units, born from the Gliss Master project, is designed to fully adapt to the needs of any wardrobe. Retaining the modules and internal compartments of the Gliss Master system, it offers an organization aimed at optimizing space, with finishes that match those of the wardrobes. The system features a Hold handle on the drawer fronts, enhancing its functionality and design. It is available in various configurations, with 3, 4, or 5 drawers, allowing you to choose the height that best fits the space. Designed to be the centerpiece of the wardrobe, the island offers a dual-side solution for optimal usability from both sides. The system is fully customizable in size and configuration.

### DATASHEET

REGISTERED  
DESIGN

2026

## FINISHES

### Notes

- No reductions of any kind or changes to the types provided are possible.
- Islands with changes in height cannot be created.

The drawer unit must always be fixed to the wall

# Molteni & C

64 —  
71

Finishes	melamine	matt lacquer colors	woods	pewter colour/bronze/iris	transparent extraclear glass	BLEND fabric	grey saffiano	Eco Skin	tatami grey melamine	black melamine
external side panel and central partition	•	•	•							
wooden drawer front	•	•	•							
glass drawer front				•	•					
fabric drawer front				•		•				
drawer internal							•			
30mm thick wooden top	•	•	•							
Eco Skin top								•		
internal structure									•	
plinth				•						•

colours	Melamine	Matt lacquer	Woods	BLEND fabric	Eco Skin
	YC sunrise chestnut	BC chalk white	RC coffee oak	bark brown	grey
	YA silver cembran	PE pearl	RF graphite oak	moss green	mink
	QC light chestnut	DN dune	RS sunrise oak	olive green	hemp
	QS dark chestnut	PL platinum	EU eucalyptus	vanilla	ivory
	QA ivory tatami	NE black		malachite	dark brown
	QG grey tatami	AT anthracite		hay	earth
	WW White	SE mustard		moon	arctic
		SI silica		storm	taupe
		DO dolomite grey		river rocks	
		AL clay			
		MK moka			
		CZ light blue grey			
		SA sand			
		RU ruby			
		PX pewter colour			
		RX copper			
		TO dove grey			
		PR petroleum blue			
		BG burgundy			
		LS london sky			
		SU stardust			
		ML moonlight			
		SP spice			
		PG pine green			
		AW almond white			
		CP cappuccino			
		IX iris			
		FG forest green			
		DB dark blue gray			
		OY oz yellow			

## DATASHEET

REGISTERED  
DESIGN

2026



**MODULARITY**

**H structure**  
 (excluding top thickness)

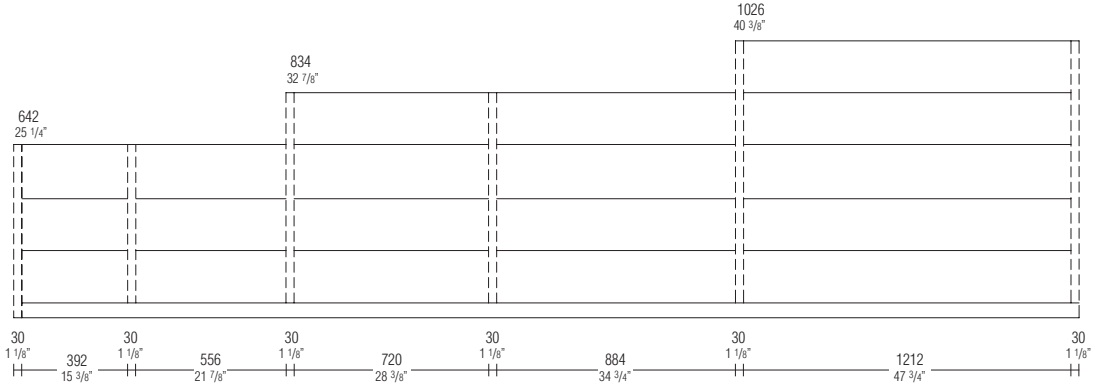

**Island**

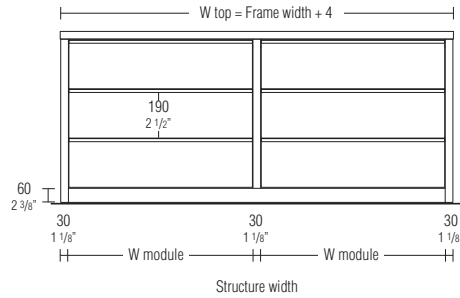
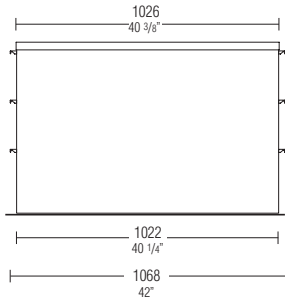

**Drawer unit**

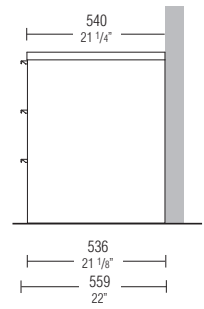

The drawer unit must always be fixed to the wall with the anti-tilt system provided

**Finishing top**

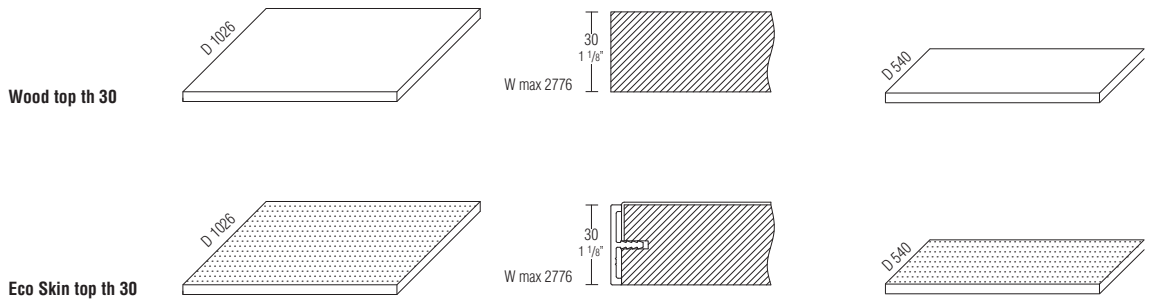

In compositions longer than the maximum size allowed for a single-piece top, it will be possible to create jointed tops ONLY in the melamine, matt lacquer or wood versions. The joint will always be made in correspondence with a central partition.

**DATASHEET**

REGISTERED  
 DESIGN

2026

**DIMENSIONS**

**island structures**  
 H 642 D 1022

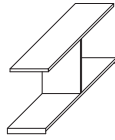

W 392  
**ICML04/06**

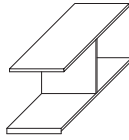

W 556  
**ICML06/06**

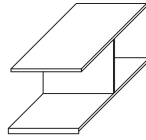

W 720  
**ICML08/06**

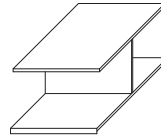

W 884  
**ICML09/06**

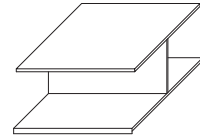

W 1212  
**ICML13/06**

**island structures**  
 H 834 D 1022

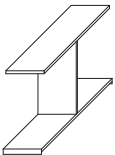

W 392  
**ICML04/08**

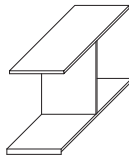

W 556  
**ICML06/08**

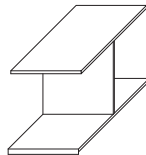

W 720  
**ICML08/08**

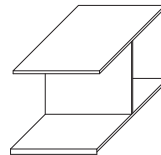

W 884  
**ICML09/08**

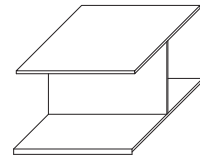

W 1212  
**ICML13/08**

**island structures**  
 H 1026 D 1022

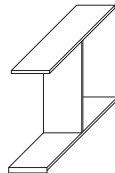

W 392  
**ICML04/09**

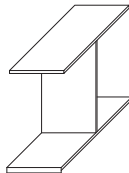

W 556  
**ICML06/09**

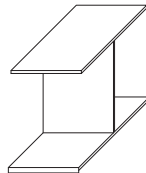

W 720  
**ICML08/09**

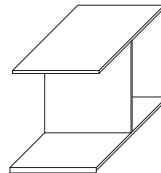

W 884  
**ICML09/09**

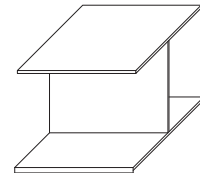

W 1212  
**ICML13/09**

**side or central panel for island**  
 D 1022 th 30

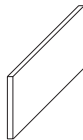

H 642  
**ICSL/06**

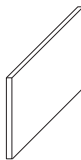

H 834  
**ICSL/08**

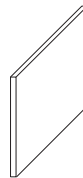

H 1026  
**ICSL/09**

**DATASHEET**

REGISTERED  
 DESIGN

2026

**DIMENSIONS**

**drawer unit structures**  
 H 642 D 536

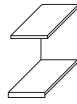

W 392  
**ICMC04/06**

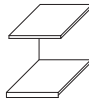

W 556  
**ICMC06/06**

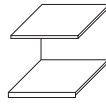

W 720  
**ICMC08/06**

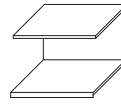

W 884  
**ICMC09/06**

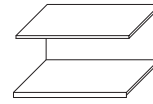

W 1212  
**ICMC13/06**

**drawer unit structures**  
 H 834 D 536

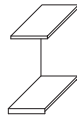

W 392  
**ICMC04/08**

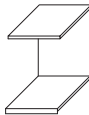

W 556  
**ICMC06/08**

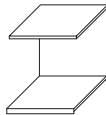

W 720  
**ICMC08/08**

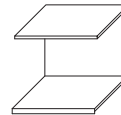

W 884  
**ICMC09/08**

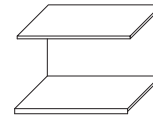

W 1212  
**ICMC13/08**

**drawer unit structures**  
 H 1026 D 536



W 392  
**ICMC04/09**

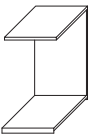

W 556  
**ICMC06/09**

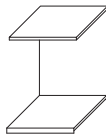

W 720  
**ICMC08/09**

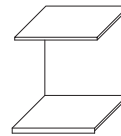

W 884  
**ICMC09/09**

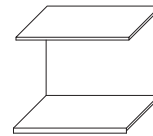

W 1212  
**ICMC13/09**

**side or central panel for drawer unit**  
 D 536 th 30



H 642  
**ICSLC/06**



H 834  
**ICSLC/08**



H 1026  
**ICSLC/09**

**DATASHEET**

REGISTERED  
 DESIGN

2026

## DIMENSIONS

### island tops D 1026 th 30

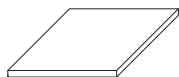

until  
W 1276  
**ICT012**

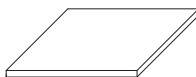

from W 1277  
to W 1534  
**ICT015**

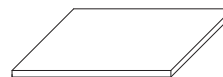

from W 1535  
to W 1862  
**ICT018**

# Molteni & C

68—  
71

### island tops D 1026 th 30



from W 1863  
to W 2518  
**ICT025**



from W 2519  
to W 2776  
**ICT027**

### drawer unit tops D 540 th 30



until  
W 1276  
**ICTOC12**

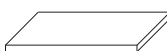

from W 1277  
to W 1534  
**ICTOC15**



from W 1535  
to W 1862  
**ICTOC18**

### drawer unit tops D 540 th 30

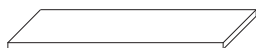

from W 1863  
to W 2518  
**ICTOC25**

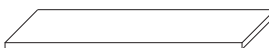

from W 2519  
to W 2776  
**ICTOC27**

## DATASHEET

REGISTERED  
DESIGN

2026

## DIMENSIONS

### wooden drawers D 478 H 190

usable space  
W 342 D 435 H 106

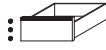

W 388  
**CLN4/19H**

usable space  
W 506 D 435 H 106

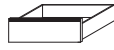

W 552  
**CLN6/19H**

usable space  
W 670 D 435 H 106



W 716  
**CLN8/19H**

usable space  
W 834 D 435 H 106



W 880  
**CLN9/19H**

usable space  
W 1162 D 435 H 106



W 1208  
**CLN13/19H**

## Molteni & C

### glass drawers D 478 H 190

usable space  
W 342 D 435 H 106

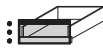

W 388  
**CVN4/19H**

usable space  
W 506 D 435 H 106



W 552  
**CVN6/19H**

usable space  
W 670 D 435 H 106

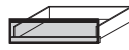

W 716  
**CVN8/19H**

usable space  
W 834 D 435 H 106

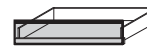

W 880  
**CVN9/19H**

usable space  
W 1162 D 435 H 106



W 1208  
**CVN13/19H**

### drawers dividers H 126/190

also usable with  
Eco Skin bottom

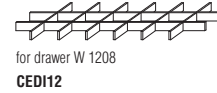
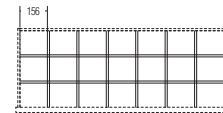
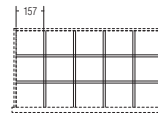
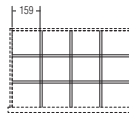
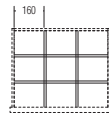
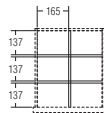

## DATASHEET

REGISTERED  
DESIGN

2026

**DIMENSIONS**

**leather trays  
 men's drawers**  
 W 206 D 430 H 58 (A)  
 W 206 D 215 H 58 (B)

**watch holder  
 (A)**

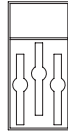

CEV/MA1

**watch/  
 bracelet holder  
 (A)**

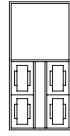

CEV/MA2

**jewellery holder  
 with movable  
 dividers  
 (B)**



CEV/MB1

**complete men's  
 drawer offer**



CVM1

**leather trays  
 women's drawers**  
 W 206 D 430 H 58 (A)  
 W 206 D 215 H 58 (B)

**watch holder  
 (A)**

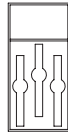

CEV/WA1

**watch/  
 bracelet holder  
 (A)**

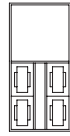

CEV/WA2

**jewellery holder  
 with movable  
 dividers  
 (B)**



CEV/WB1

**ring holder  
 (B)**



CEV/WB2

**earring holder  
 (B)**



CEV/WB3

**complete women's  
 drawer offer**



CVW1

**Modularity drawings  
 for inserting trays into  
 drawers**

drawer W 388

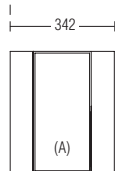

1 tray (A)  
 or 2 trays (B)

drawer W 552

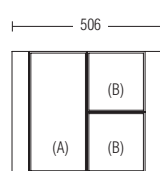

2 trays (A)  
 or 4 trays (B)

drawer W 716

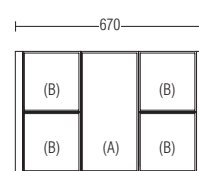

3 trays (A)  
 or 6 trays (B)

drawer W 880

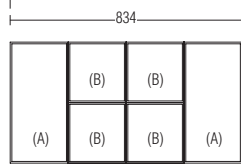

4 trays (A)  
 or 8 trays (B)

drawer W 1208

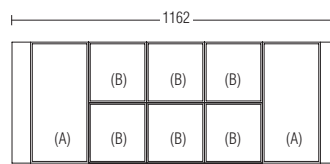

5 trays (A)  
 or 10 trays (B)

**Eco Skin bottoms  
 for drawers**

D 432/473 special for 1st drawer with glass lid



W 338  
**CEQ/F4**

W 502  
**CEQ/F6**

W 666  
**CEQ/F8**

W 830  
**CEQ/F9**

W 1158  
**CEQ/F13**

**DATASHEET**

REGISTERED  
 DESIGN

2026

## DIMENSIONS

### Locking system for drawers

The drawers of the modular islands and drawer units can be equipped with a multiple locking system. All the drawers can be closed using a single lock with key applied to the first drawer at the top. This system can be applied to all drawer widths. The multiple locking occurs thanks to the operation, via the lock, of a bar with pins embedded in the side panel.

### Notes

The key is always in nickel finish.

### closure system

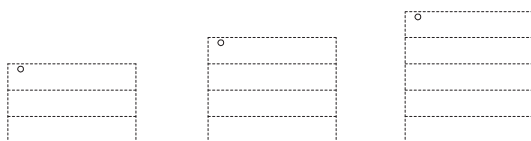

# Molteni & C

71—

71

DATASHEET

REGISTERED  
DESIGN

2026