

# Molteni & C

## OLD FORD — RODOLFO DORDONI 2023

1—  
3



The Old Ford table by Italian designer Rodolfo Dordoni perfectly embodies Molteni&C's commitment to combine aesthetics, functionality, and technical innovation. The table consists of a smooth, rounded top narrowed at the ends resting on a solid shiny base that connects the legs to an H-shaped structure. The top is carefully finished and available in coffee oak, or opaque or shiny polyester marble, giving it a warm, inviting appearance. The lower body of the table recalls a shell, featuring soft lines. The supportive frame of the table is made using the hydroforming technique, a sophisticated process commonly used in the furniture industry, in which water pressure is applied to shape the material. This process ensures that the table is lightweight but structurally rigid, guaranteeing resistance over time. The table provides ample room for sitting and eating, or, with its characteristic shape, can serve as a sculptural item at the centre of a foyer. The oval shape also allows the table to adapt to various interior layouts, making it a versatile option for any home. The Old Ford table expresses Molteni&C's commitment to achieving aesthetic originality through research and technological innovation. Attention to detail, harmonious shapes, and exceptional durability are evident in every aspect of its refined construction.

### DATASHEET

REGISTERED  
DESIGN

2026

## FINISHES

### STRUCTURE FINISHES

glossy pine green - glossy burgundy - glossy black nickel

### FINISHES WOODEN TOPS

coffee oak

### FINISHES MATT FINISH OR GLOSSY FINISH MARBLE TOPS

emperador dark - calacatta - Sahara noir



The product is available with other kinds of stone in **matt and glossy finish**, present in the Molteni&C collection, subject to feasibility and price request. For more information please contact the Sales Office.

# Molteni&C

## TECHNICAL INFORMATION

### WOOD TOP

Medium density fibreboard panel shaped and covered in wood veneer.

### MARBLE TOP

Marble in the range of finishes specific for the product.

### STRUCTURE

Legs made by hydroforming and central crosspiece by hydroforming and coning, painted in the finishes of the specific range for the product. Top support frame in epoxy painted metal.

### UNDERTOP

Lacquered anthracite medium-density fibreboard.

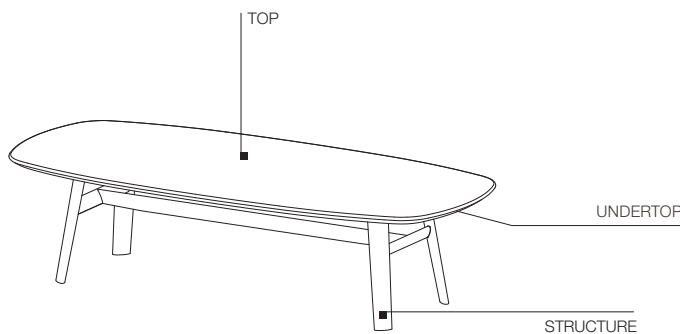

## DATASHEET

REGISTERED  
DESIGN

2026

**DIMENSIONS**

**Notes**

No reductions of any kinds are available.

Tables

**wooden top**  
 section

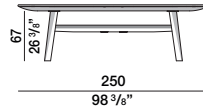
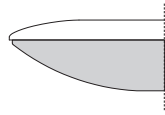

**OTE2**

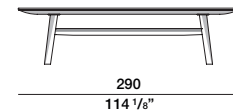
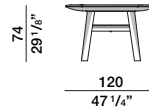

**OTE3**

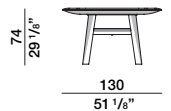

Tables

**marble top**  
 section

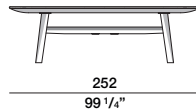
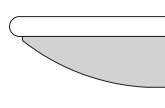

**OTM2**

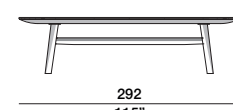
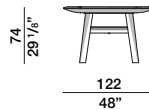

**OTM3**

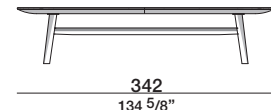

**OTM4**

