

## EDMOND — CHRISTOPHE DELCOURT 2026

1—  
5



Il sistema di divani componibili Edmond nasce come un esercizio di architettura domestica, in cui il comfort si fa espressione funzionale e la visione stilistica rimane in costante evoluzione. Lo schienale si modella, la profondità della seduta si calibra, suggerendo modalità d'uso sempre diverse senza mai imporle, lasciando spazio a un abitare libero e personale. Il piping a contrasto agisce come un filo conduttore, una linea tracciata a matita che attraversa il progetto. Un segno sottile ma eloquente, capace di mettere in evidenza appoggi, angoli, e punti di connessione, rendendo leggibile la costruzione e il disegno del volume. In Edmond, l'organicità delle forme incontra un rigore progettuale reso fluido. Il sistema modulare moltiplica le possibilità di vivere questo arredo, cuore pulsante di accoglienza, dove comfort, relazione e libertà compositiva trovano un equilibrio naturale.



Il simbolo indica che questo prodotto è dotato di rivestimento sfoderabile. In alcuni casi, il prodotto è sfoderabile, ma solo da personale qualificato; questa evenienza viene evidenziata nelle avvertenze.



Il simbolo indica che il prodotto è disponibile, su richiesta, in versione ignifuga in ottemperanza alle normative BS 5852 e TB 117-2013.

È responsabilità dell'acquirente verificare che il prodotto sia idoneo e conforme ai requisiti richiesti per la destinazione d'uso e alle normative vigenti nel luogo di destinazione e utilizzo del prodotto.

SCHEDA  
TECNICA

REGISTERED  
DESIGN

2026

## INFORMAZIONI TECNICHE

### INTERNO STRUTTURA SEDUTA

Telaio composto da legno massello di Abete (Picea abies) e pannelli di particelle di legno, con cinghie elastiche.

### INTERNO STRUTTURA SCHIENALE

Telaio composto da pannelli di multistrato di legno.

### IMBOTTITURA STRUTTURA SEDUTA

Poliuretano espanso ad alta portanza. Fodera in vellutino accoppiato cotone/fibra poliestere.

### IMBOTTITURA STRUTTURA SCHIENALE

Poliuretano espanso a densità variabile e fodera in vellutino accoppiato cotone/fibra poliestere.

### CUSCINI SEDUTA

Insero in poliuretano sagomato a densità variabile, fodera in cotone 100%.

### CUSCINI SCHIENALE

Fibra di poliestere, fodera in cotone 100%.

### PIEDINI

Acciaio verniciato con puntali antiscivolo in materiale plastico.

### RIVESTIMENTO ESTERNO SFODERABILE

(Vedi scheda allegata, specifica del rivestimento).



PRODOTTO DISPONIBILE  
IN VERSIONE CONFORME  
A TB117 O BS5852

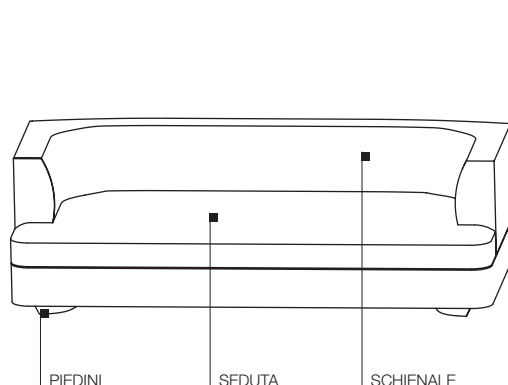

PIEDINI

SEDUTA

SCHIENALE

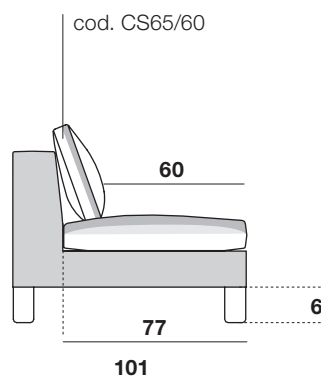

cod. CS65/60

60

77

101

6

Profondità di seduta solo struttura 77 cm  
Profondità di seduta con cuscino schienale cod. CS65/60 cm 60  
Altezza da pavimento a sotto divano 6 cm

## AVVERTENZE

- Per la corretta ergonomia e per godere del massimo confort si consiglia di progettare ogni modulo utilizzando uno o più cuscini schienale, secondo le misure proposte a listino. Oltre alla corretta ergonomia la presenza di questi elementi conferisce al prodotto un aspetto estetico completo ed elegante.
- Le strutture ed i cuscini, sia nelle versioni in tessuto che nelle versioni pelle, sono confezionati con un profilo in grosgrain nei colori indicati nel capoverso finiture.

## FINITURE

FINITURE GROSGRAIN  
antracite  
testa di moro  
verde oliva  
bianco carta  
castoro  
cuoio  
ferro  
nero  
panna  
sabbia  
topo

**DIMENSIONI**

**divano**

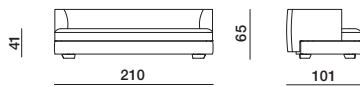

**DI2110**

**divano**

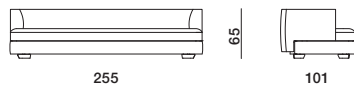

**DI2510**

**terminale**

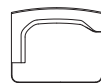

**TL1210 dx-sx**

**terminale**

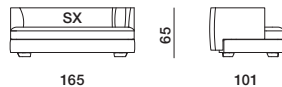

**TL1610 dx-sx**

**terminale**



**TL2110 dx-sx**

**cuscin  
schienale**



**CS65/60**

**cuscin  
schienale**



**CS65/60**

**cuscin  
schienale**



**CS45/45**

**cuscin  
schienale**



**CS45/45**

**cuscin  
schienale  
ornamentale**

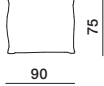

**PCU90/75**

**cuscin  
schienale  
ornamentale**

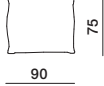

**PCU90/75**

**cuscin  
schienale**



**CS65/60**

**cuscin  
schienale**



**CS45/45**

**cuscin  
schienale  
ornamentale**

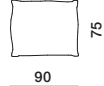

**PCU90/75**

**cuscin  
schienale**



**CS65/60**

**cuscin  
schienale**



**CS45/45**

**cuscin  
schienale  
ornamentale**

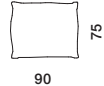

**PCU90/75**

**cuscin  
schienale**



**CS65/60**

**cuscin  
schienale**



**CS45/45**

**cuscin  
schienale  
ornamentale**

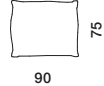

**PCU90/75**

**DIMENSIONI**

**terminale curvo**

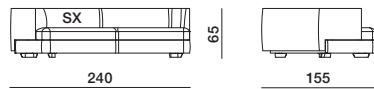

TC2415 dx-sx

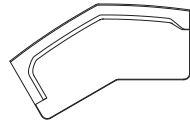

**centrale**



CE1210



**centrale**

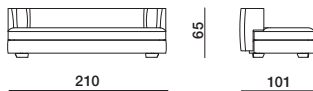

CE2110



**centrale**

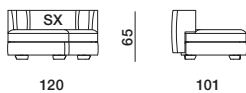

CA1210 dx-sx



**angolo**



AN1313



**cuscinò  
schienale**



CS65/60

**cuscinò  
schienale**



CS45/45

**cuscinò  
schienale  
ornamentale**

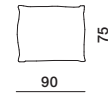

PCU90/75

**cuscinò  
schienale**



CS65/60

**cuscinò  
schienale**



CS45/45

**cuscinò  
schienale  
ornamentale**

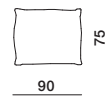

PCU90/75

**cuscinò  
schienale**



CS65/60

**cuscinò  
schienale**



CS45/45

**cuscinò  
schienale  
ornamentale**

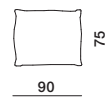

PCU90/75

**cuscinò  
schienale**



CS65/60

**cuscinò  
schienale**



CS45/45

**cuscinò  
schienale  
ornamentale**

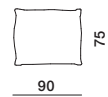

PCU90/75

**cuscinò  
schienale**



CS65/60

**cuscinò  
schienale**



CS45/45

**cuscinò  
schienale  
ornamentale**

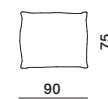

PCU90/75

**DIMENSIONI**

**angolare**

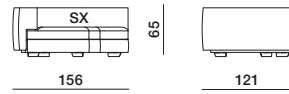

**AN1512 dx-sx**

**angolare grande**

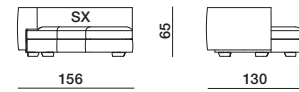

**AN1513 dx-sx**

**isola**



**IS1810 dx-sx**

**chaise longue**



**CL1213 dx-sx**

**pouf**

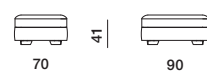

**PF0709**

**cuscin  
schienale**



**CS65/60**

**cuscin  
schienale**



**CS65/60**

**cuscin  
schienale**



**CS45/45**

**cuscin  
schienale**



**CS45/45**

**cuscin  
schienale  
ornamentale**

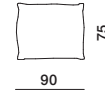

**PCU90/75**

**cuscin  
schienale  
ornamentale**

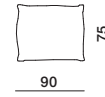

**PCU90/75**

**cuscin  
schienale**



**CS65/60**

**cuscin  
schienale**



**CS45/45**

**cuscin  
schienale  
ornamentale**

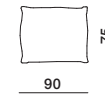

**PCU90/75**

**cuscin  
schienale**



**CS65/60**

**cuscin  
schienale**



**CS45/45**

**cuscin  
schienale  
ornamentale**

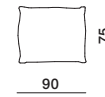

**PCU90/75**