

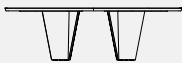

# CONTENT



Tables

pp 12-137



Home office

pp 138-167



Chairs

pp 168-255

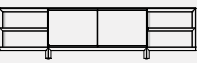

Single furniture  
and bookcases

pp 256-331



Mirrors

pp 332-335

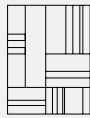

Carpet  
collection

pp 336-367



# OVERVIEW

## TABLES



Arc Foster + Partners - p. 92



Asterias Patricia Urquiola - p. 118



Ava Table Foster + Partners - p. 106



P n lope Christophe Delcourt - p. 44



Blevio Ignazio Gardella - p. 22



D.8591 Gio Ponti - p. 14



Diamond Patricia Urquiola - p. 62



Filigree Rodolfo Dordoni - p. 48



Gatwick Rodolfo Dordoni - p. 100



Half a Square Michael Anastassiades - p. 126



Lise Christophe Delcourt - p. 34



Mateo Vincent Van Duysen - p. 72



Old Ford Rodolfo Dordoni - p. 110

## HOME OFFICE



Aria Vincent Van Duysen - p. 144



D.8471 Gio Ponti - p. 140

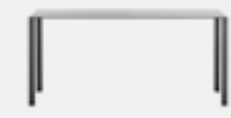

LessLess Jean Nouvel - p. 150



Note Matteo Nunziati - p. 154

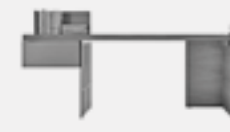

Scriba Patricia Urquiola - p. 158



Touch Down Unit Studio Klass - p. 162



# OVERVIEW

## CHAIRS



**123** *Michael Anastassiades* - p. 246



**Barbican** *Rodolfo Dordoni* - p. 216



**Chelsea** *Rodolfo Dordoni* - p. 210



**Outline** *Arik Levy* - p. 194



**Porta Volta** *Herzog & de Meuron* - p. 222



**Tea** *Jasper Morrison* - p. 252



**Devon** *Rodolfo Dordoni* - p. 204



**D.235.1 Montecatini** *Gio Ponti* - p. 190



**Glove / Glove-Up** *Patricia Urquiola* - p. 234 / p. 238



**Woody** *Francesco Meda* - p. 242



**Janet** *Vincent Van Duysen* - p. 230



**MHC.3 Miss** *Tobia Scarpa* - p. 184



**Monk** *Tobia Scarpa* - p. 170



# OVERVIEW

## SINGLE UNITS



**Adrien** *Vincent Van Duysen* - p. 296



**Andromeda** *Studio LSM* - p. 266



**Carteggio** *Aldo Rossi* - p. 302



**D.655.1 D.655.2** *Gio Ponti* - p. 258



**Horizons** *Dante Bonuccelli* - p. 290



**Living Box** *Vincent Van Duysen* - p. 272



**MHC.1** *Werner Blaser* - p. 262



**Teorema** *Ron Gilad* - p. 292

## BOOKCASES

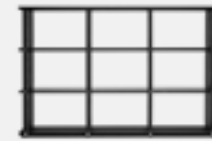

**Card** *Michael Anastassiades* - p. 326



**D.355.1 D.355.2** *Gio Ponti* - p. 308



**D.357.1 D.357.2** *Gio Ponti* - p. 304

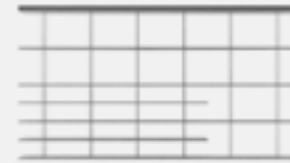

**Graduate** *Jean Nouvel* - p. 316



**MHC.2** *Yasuhiko Itoh* - p. 312



**Piroscalo** *Aldo Rossi, Luca Meda* - p. 322

## MIRRORS

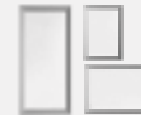

**D.950.1** *Gio Ponti* - p. 332



**Hector Mirror** *Vincent Van Duysen* - p. 334

# OVERVIEW

## CARPET COLLECTION



**D7541**  
Gio Ponti - Heritage Collection - p. 338



**Aura**  
Nicola Gallizia - p. 340



**Dedalo**  
by Pierre Frey - Marta Ferri - p. 342



**Random**  
by Altai- Patricia Urquiola - p. 356

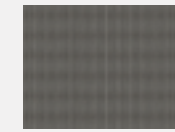

**Roads**  
Marta Ferri - p. 358



**Sonoro**  
Nicola Gallizia - p. 360



**Duna**  
Nicola Gallizia - p. 344



**Edge**  
Nicola Gallizia - p. 346



**Eone**  
Nicola Gallizia - p. 348



**Stripe**  
Vincent Van Duysen - p. 362



**Telaro**  
by Armini - Marta Ferri - p. 364



**Vibrazioni**  
Marta Ferri - p. 366



**Hem**  
by G.T.Design - Patricia Urquiola - p. 350



**Orizzonti**  
Marta Ferri - p. 352



**Palette**  
Nicola Gallizia - p. 354



MOLTENI MAKE FURNITURE BY BUILDING ON TRADITION, ADDING EXPERIENCE TO EXPERIENCE. BY APPLYING TECHNICAL INNOVATION TO TIME-HONOURED SKILLS THEY ACHIEVE UNEXPECTED, INGENUOUS ADVANCES. THE DURABILITY OF FURNITURE DEPENDS ON GOOD WORKMANSHIP BUT ALSO ON THE COMPLETENESS AND SUITABILITY OF THE FORMS. MATERIALS HAVE TO BE “GOOD” MATERIALS, BUT ARE ONLY SUCH IF USED IN KEEPING WITH THEIR POTENTIAL, THEIR HISTORY AND THEIR PURPOSE.

MOLTENI COSTRUISCE MOBILI SVILUPPANDO LA TRADIZIONE. AD ESPERIENZA AGGIUNGE ESPERIENZA. L'INNOVAZIONE TECNICA CONSENTE DI SVILUPPARE IN DIREZIONI IMPREVISTE I RISULTATI SEDIMENTATI DAL TEMPO. LA DURATA DEI MOBILI È LEGATA ALLA BUONA FATTURA, MA ANCHE ALLA COMPIUTEZZA E ALL'ADEGUATEZZA DELLE FORME. I MATERIALI DEVONO ESSERE “BUONI” MATERIALI, MA DIVENTANO TALI SE SONO COERENTI CON LE LORO POSSIBILITÀ, CON LA LORO STORIA E IL LORO USO.

tables





## D.859.1

GIO PONTI

In 1958 Gio Ponti was enlisted to design the auditorium for the Time&Life Building at 1271 Avenue of the Americas in New York. The building housed the headquarters of Time Inc., publisher of influential historical magazines such as Time, Life, Fortune, People, and Sports Illustrated. This was Ponti's most prestigious project in New York. The D.859.1 table, designed primarily as a meeting table for up to ten people, stands out among the auditorium furnishings not only for its impressive size—over 3,60 meters long—but especially for its simple yet refined design. The legs are notable for their fine-membered modernity, creating a trapezoidal single-span bridge upon which the large tapered top conveys the idea of aerodynamics. Originally made of solid ash with bronze ferrules, it is now also available in a darker-toned wood such as Black Stained Ash. In addition to its original dimensions, the D.859.1 is available in two smaller version that faithfully reproduce the harmony and proportions of the original design.

Nel 1958 viene affidato a Gio Ponti l'incarico di progettare l'auditorium annesso al Time&Life building, al 1271 di Avenue of the Americas a New York, sede della Time Inc., casa editrice di storiche e influentissime testate come Time, Life, Fortune, People e Sports Illustrated. È l'incarico più importante per Ponti a New York. Il tavolo D.859.1, utilizzato principalmente come grande tavolo per conferenze, fino a dieci posti, spicca tra gli arredi dell'auditorium non solo per le sue imponenti dimensioni, oltre 3,60 mt di lunghezza, ma soprattutto per il disegno raffinato ed essenziale. La base trapezoidale si impone per la sua leggerezza e modernità. Un vero e proprio ponte a campata unica, su cui poggia un piano di grandi dimensioni dalla forma affusolata che ne accentua l'aerodinamicità. Realizzato al tempo in frassino massello con puntali in ottone, viene riproposto sia in versione originale che in un legno dalle tonalità scure come il frassino tinto nero. Oltre alle dimensioni originali, D.859.1 è disponibile in due dimensioni più contenute che rispettano fedelmente l'armonia e le proporzioni del progetto originale.

HERITA-  
GE COL-  
LECTION



D.859.1 —

TABLE—  
ASH WOOD STAINED BLACK,  
SATIN BRASS FEET  
MHC.3 MISS CHAIRS—  
ASH WOOD STAINED BLACK,  
L200 LEATHER  
PALETTE CARPET—

TAVOLO—  
FRASSINO TINTO NERO,  
PIEDI OTTONE SATINATO  
SEDIE MHC.3 MISS—  
FRASSINO TINTO NERO,  
PELLE L200  
TAPPETO PALETTE—





D.859.1 —

TABLE—  
ASH WOOD IN NATURAL COLOUR,  
SATIN BRASS FEET  
MHC.3 MISS CHAIR—  
ASH WOOD IN NATURAL COLOUR,  
HANDWOVEN PAPER CORD  
ECRU COLOUR  
EDGE CARPET—

TAVOLO—  
FRASSINO NATURALE,  
PIEDI OTTONE SATINATO  
SEDIAMO MHC.3 MISS—  
FRASSINO NATURALE,  
CORDA  
COLORE ECRU  
TAPPETO EDGE—



D.859.1 —

TABLE—  
ASH WOOD IN NATURAL COLOUR  
D.655.1 CHEST OF DRAWERS—  
ELM, ITALIAN WALNUT,  
MAHOGANY, ROSEWOOD,  
WHITE HAND-PAINTED,  
SATIN BRASS  
MHC.3 MISS CHAIR—  
ASH WOOD IN NATURAL COLOUR,  
HANDWOVEN PAPER CORD  
ECRU COLOUR  
EDGE CARPET—

TAVOLO—  
FRASSINO NATURALE  
CASSETTONE D.655.1—  
OLMO, NOCE NAZIONALE,  
MOGANO, PALISSANDRO,  
VERNICIATO A MANO BIANCO,  
OTTONE SATINATO  
SEDIA MHC.3 MISS—  
FRASSINO NATURALE,  
CORDA  
COLORE ECRÙ  
TAPPETO EDGE—

# BLEVIO

IGNAZIO GARDELLA

Ignazio Gardella's Blevio table joins Molteni&C's Heritage Collection, inaugurating a partnership with the Gardella Historical Archive: the first episode of a relationship based on research and exchange, destined to develop over the years to come. Elegant and geometrically linear, the Blevio table is rich in design, in details that reveal themselves to the attentive eye. It is a project that focuses on the essential and on the removal of decoration for decoration's sake. The refined and unusual play of counter curves is also a structural stabilizing element: the geometric center of the semicircular extremities of the table top coincides with that of the vertical supports.

Il tavolo Blevio di Ignazio Gardella entra a far parte dell'Heritage Collection di Molteni&C, inaugurando la collaborazione con l'Archivio Storico Gardella: primo episodio di una relazione di ricerca e di scambio, destinata a svilupparsi nei prossimi anni. Elegante e dalla geometricità lineare, il tavolo Blevio è ricco di disegno, di dettagli che si svelano a un'osservazione attenta. È un progetto che si concentra sull'essenziale e sull'abbandono del decoro fine a se stesso. Il gioco di controcurve, raffinato e inedito, è anche un elemento di stabilizzazione strutturale: il centro geometrico delle estremità semicircolari del piano coincide con quello dei sostegni verticali.

**HERITA-**  
**GE COL-**  
**LECTION**



BLEVIO —

TABLE—  
ECLIPSE STRUCTURE AND TOP  
505 UP SYSTEM—  
505 UP SIDEBOARD—  
JANET CHAIR—  
STRIPE CARPET—

TAVOLO—  
STRUTTURA E PIANO ECLIPSE  
505 UP SYSTEM—  
505 UP SIDEBOARD—  
SEDIA JANET—  
TAPPETO STRIPE—





BLEVIO —

TABLE—  
ECLIPSE STRUCTURE AND TOP  
STRIPE CARPET—

TAVOLO—  
STRUTTURA E PIANO ECLIPSE  
TAPPETO STRIPE—



BLEVIO —

TABLE—  
ECLIPSE STRUCTURE  
BRECCIA CAPRAIA TOP  
PORTA VOLTA CHAIRS—  
505 UP SYSTEM—  
STRIPE CARPET—

TAVOLO—  
STRUTTURA ECLIPSE  
PIANO BRECCIA CAPRAIA  
SEDIE PORTA VOLTA—  
505 UP SYSTEM—  
TAPPETO STRIPE—







BLEVIO —

TABLE—  
ECLIPSE STRUCTURE  
BRECCIA CAPRAIA TOP

TAVOLO—  
STRUTTURA ECLIPSE  
PIANO BRECCIA CAPRAIA



BLEVIO —

TABLE—  
ECLIPSE STRUCTURE  
BRECCIA CAPRAIA TOP  
JANET CHAIRS—

TAVOLO—  
STRUTTURA ECLIPSE  
PIANO BRECCIA CAPRAIA  
SEDIE JANET—



# LISE

CHRISTOPHE DELCOURT

A table of great aesthetic significance, designed to enrich the most refined and airy home spaces with elegance. The Lise table is characterized by a strong sculptural presence. The harmony of forms is elegantly expressed by the two opposing, curved base structures that intertwine, reaching upwards with grace. Made of rigid polyurethane, the shapes of the base can be finished with a high-gloss lacquered finish or covered with a sheet of polished steel. The top is available in wood with a glossy lacquered rim or in rich marble with a glossy steel rim. The finish of the rim is consistently mirrored in the base, creating a material continuity between the top and base, giving Lise a distinctive aesthetic.

Tavolo di grande rilevanza estetica pensato per arricchire con eleganza gli spazi domestici più raffinati e spaziosi. Il tavolo Lise è caratterizzato da un forte carattere scultoreo. L'armonia di forme viene elegantemente raccontata dalle due strutture contrapposte ricurve della base che si insinuano una nell'altra slanciate verso l'alto. Realizzate in poliuretano rigido le forme della base possono essere completate con una finitura laccato lucido o rivestite da una lastra di acciaio lucido. Il piano è disponibile con finitura in essenza arricchita da un bordo in laccato lucido o nella ricca finitura in marmo con bordo acciaio lucido. La finitura del bordo viene sempre ripresa dal basamento, creando continuità materica tra top e base e donando a Lise un'estetica decisa e mai banale.



LISE —

TABLE—  
SHINY STEEL STRUCTURE  
AND TOP FRAME,  
MALDIVE WHITE MARBLE TOP  
MONK CHAIRS—  
EONE CARPET—

TAVOLO—  
STRUTTURA E CORNICE TOP  
ACCIAIO LUCIDO,  
TOP MARMO MALDIVE WHITE  
SEDIE MONK—  
TAPPETO EONE—





LISE —

TABLE—  
SHINY STEEL STRUCTURE  
AND TOP FRAME,  
MALDIVE WHITE MARBLE TOP  
MONK CHAIRS—  
EONE CARPET—

TAVOLO—  
STRUTTURA E CORNICE TOP  
ACCIAIO LUCIDO,  
TOP MARMO MALDIVE WHITE  
SEDIE MONK—  
TAPPETO EONE—



LISE —

TABLE—  
BURGUNDY GLOSSY LACQUERED  
STRUCTURE AND TOP FRAME,  
COFFEE OAK TOP  
123 CHAIRS—  
LOGOS LIVING SYSTEM—  
ARIAL BOISERIE—  
ORIZZONTI CARPET—

TAVOLO—  
STRUTTURA E CORNICE TOP  
LACCATO LUCIDO BORGOGNA,  
TOP ROVERE CAFFE  
SEDIE 123—  
LIVING SYSTEM LOGOS—  
BOISERIE ARIAL—  
TAPPETO ORIZZONTI—



LISE —

TABLE—  
BURGUNDY GLOSSY LACQUERED  
STRUCTURE AND TOP FRAME,  
COFFEE OAK TOP  
DEVON CHAIRS—  
LOGOS LIVING SYSTEM—  
ARIAL BOISERIE—  
ORIZZONTI CARPET—

TAVOLO—  
STRUTTURA E CORNICE TOP  
LACCATO LUCIDO BORGOGNA,  
TOP ROVERE CAFFÈ  
SEDIE DEVON—  
LIVING SYSTEM LOGOS—  
BOISERIE ARIAL—  
TAPPETO ORIZZONTI—



# PÉNÉLOPE

CHRISTOPHE DELCOURT

Console designed with an organic vision of design, where form and function merge in balance. The base features two opposing curved structures with plastic and harmonious shapes that interlock, creating a sculptural effect reminiscent of the design of the Lise table. Made of rigid polyurethane, the shapes of the base can be finished with a high-gloss lacquered finish or covered with a sheet of polished steel. Above, a skillfully joined polymorphic top is available in marble with a glossy steel edge or in wood with a glossy lacquered edge. The edge finish is echoed in the base, creating a material continuity that gives the console a bold aesthetic with a strong visual presence.

Consolle progettata secondo una visione organica del design in cui forma e funzione si fondono con equilibrio. Il basamento è caratterizzato da due strutture contrapposte ricurve dalle forme plastiche e armoniche che si insinuano una dentro l'altra creando un effetto scultoreo che richiama il design del tavolo Lise. Realizzate in poliuretano rigido le forme della base possono essere completate con una finitura laccato lucido o rivestite da una lastra di acciaio lucido. Sopra, un piano poliforme sapientemente raccordato disponibile in marmo con bordo in acciaio lucido oppure in essenza con bordo laccato lucido. La finitura del bordo viene ripresa nel basamento creando una continuità materica che dona un'estetica decisa e dalla forte presenza scenica.

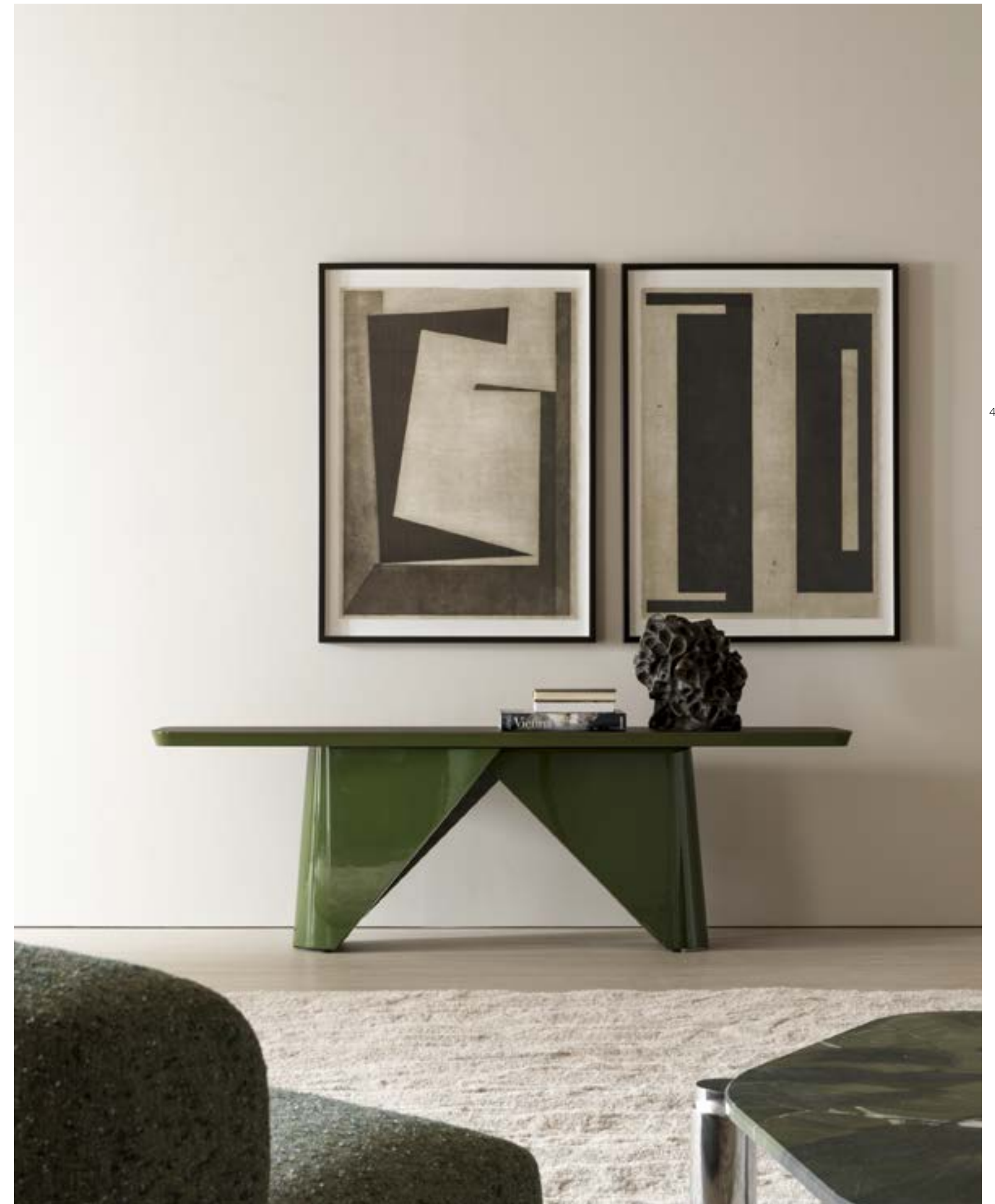



PÉNÉLOPE —

CONSOLE—  
SHINY STEEL STRUCTURE  
AND TOP FRAME,  
LEPANTO RED MARBLE TOP

FOREST GREEN GLOSSY  
LACQUERED STRUCTURE AND  
TOP FRAME, COFFEE OAK TOP

CONSOLLE—  
STRUTTURA E CORNICE TOP  
ACCIAIO LUCIDO,  
TOP MARMO ROSSO LEPANTO

STRUTTURA E CORNICE TOP  
LACCATO LUCIDO FOREST GREEN,  
TOP ROVERE CAFFÈ



# FILIGREE

RODOLFO DORDONI

Filigree is a range of fixed size and extendable tables. Diecast aluminium frames underpin tops enhanced by a wide range of finishes. The technological devices adopted play a key role with telescopic extension systems, thin reinforced tops and dedicated surface treatments for each type of material used. The structure is now offered with a refined Iridium brown finish, a metallic surface with a warm, soft-to-the-touch tone. This new color, which integrates harmoniously with the entire Molteni&C production, is further enhanced by new stone tops in Ecotone™ (in Sienna and Poseidon variants) or in Eucalyptus wood with inlay. The wood top is distinguished by exquisite craftsmanship, reinterpreted in an industrial key, with a "herringbone" inlay, available exclusively in Eucalyptus wood. This inlay work is available in all sizes, including the extendable version.

Filigree è una serie di tavoli fissi ed allungabili. Strutture in alluminio pressofuso si sposano con piani in diverse finiture. La tecnologia impiegata è protagonista discreta, con sistemi di allungamento telescopico, piani rinforzati a spessore ridotto, trattamenti delle superfici specifici per ogni tipo di materiale impiegato. La struttura viene ora proposta con una raffinata finitura Iridium brown, una superficie metallica dal tono caldo e morbido al tatto. Questo nuovo colore, che si inserisce armoniosamente nell'intera produzione Molteni&C, viene ulteriormente valorizzato dai nuovi piani in pietra, Ecotone™ (nelle varianti Sienna e Poseidon) o in essenza di Eucalipto intarsiata. Il piano in essenza si distingue per una pregiata lavorazione artigianale, reinterpreta in chiave industriale, con l'intarsio a "spina di pesce", disponibile esclusivamente per l'essenza Eucalipto. Questa lavorazione è disponibile su tutte le misure, inclusa la versione allungabile.



FILIGREE —

EXTENDABLE TABLE—  
IRIDIUM BROWN STRUCTURE,  
EUCALYPTUS TOP WITH INLAY  
OUTLINE CHAIRS—  
ARIAL BOISERIE—  
EONE CARPET—

TAVOLO ALLUNGABILE—  
STRUTTURA IRIDIUM BROWN,  
TOP EUCALIPTO CON INTARSIO  
SEDIE OUTLINE—  
BOISERIE ARIAL—  
TAPPETO EONE—



FILIGREE —

TABLE—  
IRIDIUM BROWN  
STRUCTURE,  
AVOCADUS GREEN  
MARBLE TOP

EUCALYPTUS TOP  
WITH INLAY

TAVOLO—  
STRUTTURA  
IRIDIUM BROWN,  
TOP MARMO  
AVOCADUS GREEN

TOP EUCALIPTO  
CON INTARSIO



FILIGREE —

EXTENDABLE TABLE—  
IRIDIUM BROWN STRUCTURE,  
EUCALYPTUS TOP WITH INLAY  
OUTLINE CHAIRS—  
ARIAL BOISERIE—  
ROADS CARPET—

TAVOLO ALLUNGABILE—  
STRUTTURA IRIDIUM BROWN,  
TOP EUCALIPTO CON INTARSIO  
SEDIE OUTLINE—  
BOISERIE ARIAL—  
TAPPETO ROADS—



FILIGREE —

EXTENDABLE TABLE—  
IRIDIUM BROWN STRUCTURE,  
EUCALYPTUS TOP WITH INLAY  
OUTLINE CHAIRS—  
ARIAL BOISERIE—  
ROADS CARPET—

TAVOLO ALLUNGABILE—  
STRUTTURA IRIDIUM BROWN,  
TOP EUCALIPTO CON INTARSIO  
SEDIE OUTLINE—  
BOISERIE ARIAL—  
TAPPETO ROADS—

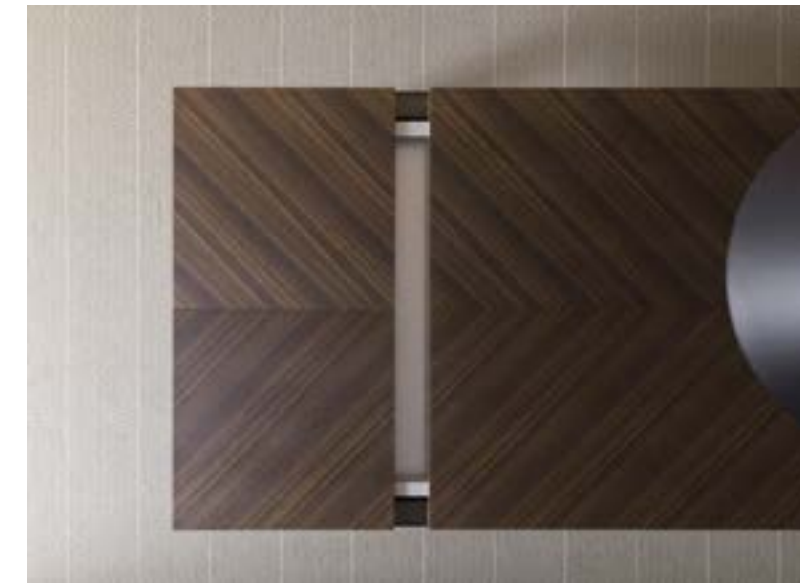

FILIGREE —

TABLE—  
BLACK NICKEL STRUCTURE,  
WHITE CARRARA MARBLE TOP  
CHELSEA CHAIRS—  
GRAPHITE OAK,  
HEM CARPET—

TAVOLO—  
STRUTTURA NICKEL NERO,  
PIANO MARMO BIANCO CARRARA  
SEDIE CHELSEA—  
ROVERE GRAFITE,  
TAPPETO HEM—





## FILIGREE —

TABLE—  
BLACK NICKEL STRUCTURE,  
WHITE CARRARA MARBLE TOP  
CHelsea CHAIRS—  
GRAPHITE OAK,  
HEM CARPET—

TAVOLO—  
STRUTTURA NICKEL NERO,  
PIANO MARMO BIANCO CARRARA  
SEDIE CHELSEA—  
ROVERE GRAFITE,  
TAPPETO HEM—





# DIAMOND

PATRICIA URQUIOLA

A range of tables with wrapped and folded feet like a delicate origami. The square or rectangular tops are available in glass or marble, the support structure is matt or glossy lacquered, copper or pewter colour (metallic finishes). The table is enhanced in 2025 with new finishes. The glossy finish is now also available on the top, and new stones and marbles are introduced, along with a new material: Ecotone™, a new-generation quartzite slab with a more sustainable formulation that reduces environmental impact.

Una serie di tavoli dalla gamba piegata e incartata come un delicato origami. I piani, quadrati o rettangolari, sono disponibili in vetro o marmo, da comporre con strutture di sostegno in laccato opaco o lucido, rame o peltro (finiture metalliche). Il tavolo viene valorizzato nel 2025 da nuove finiture. La finitura lucida viene portata anche sul piano ed entrano in collezione nuove pietre e marmi oltre ad un nuovo materiale: Ecotone™, una quarzite di nuova generazione in lastra con una formulazione più sostenibile e attenta all'impatto ambientale.



DIAMOND —

TABLE—  
BURGUNDY GLOSSY  
LACQUERED STRUCTURE  
AND TOP  
GLOVE-UP CHAIRS—

TAVOLO—  
STRUTTURA E TOP  
LACCATO LUCIDO  
BORGOGNA  
SEDIE GLOVE-UP—

DIAMOND —

TABLE—  
PEWTER STRUCTURE,  
ECOTONE™ SIENNA TOP  
MONK CHAIRS—  
GRADUATE BOOKCASE—  
STRIPE CARPET—

TAVOLO—  
STRUTTURA PELTRO,  
TOP ECOTONE™ SIENNA  
SEDIE MONK—  
LIBRERIA GRADUATE—  
TAPPETO STRIPE—





DIAMOND —

TABLE—  
PEWTER STRUCTURE,  
ECOTONE™ SIENNA TOP  
STRIPE CARPET—

TAVOLO—  
STRUTTURA PELTRO,  
TOP ECOTONE™ SIENNA  
TAPPETO STRIPE—



DIAMOND —

TABLE—  
PEWTER STRUCTURE,  
GRAPHENE GLASS TOP  
TEA CHAIR—

PEWTER STRUCTURE,  
SAHARA NOIR MARBLE TOP  
GLOVE CHAIRS—

TAVOLO—  
STRUTTURA PELTRO,  
PIANO VETRO GRAFENE  
SEDIA TEA—

STRUTTURA PELTRO,  
PIANO MARMO SAHARA NOIR  
SEDIE GLOVE—



# MATEO

VINCENT VAN DUYSSEN

The Mateo table introduces fresh possibilities in 2024. Featuring a characteristic central base with a conical shape, vertically grooved at the base, this table is enriched with new compositional options. Available in both dining and lounge versions, the Mateo table offers a range of sizes to accommodate various settings. The dining version includes round tops in sizes 140, 160, 180 and 200 cm, as well as oval tops in 220 and 250 cm, supplemented by a new version with two bases and oval top in marble in 300, 350 and 400 cm version, perfect for larger spaces and social gatherings. The distinctive conical base is now offered with a polished steel finish, in addition to classic options such as coffee oak, sunrise oak, glossy lacquers, and burnished metal. Representing a modern approach to dining, this table boasts scalable proportions and sleek lines, designed to elevate the art of entertaining.

Il tavolo Mateo, dotato di un caratteristico basamento centrale dalla forma conica solcata in due nella verticale alla base, si arricchisce nel 2024 di nuove possibilità compositive. Il tavolo Mateo resta disponibile in due versioni: dining e lounge. Nella versione dining, al piano tondo nelle dimensioni 140, 160, 180, 200 cm e a quello ovale in 220 e 250 cm, si aggiunge la nuova versione a due basamenti della versione ovale, disponibile solo in marmo per le dimensioni da 300, 350, 400 e adatta per arricchire gli spazi più ampi e ospitare momenti di convivialità. La caratteristica base conica si arricchisce di una finitura in acciaio lucido in aggiunta a quelle classiche in rovere caffè, rovere sunrise, nell'intera gamma dei laccati lucidi e in metallo brunito. Un moderno concetto di dining: un tavolo dalle proporzioni scalabili e dalle linee pulite, pensato per l'arte del ricevere.



MATEO —

OVAL DINING TABLE—  
ALMOND WHITE  
GLOSSY LACQUER  
BASE AND TOP  
JANET CHAIRS—  
505 UP SIDEBOARD—  
EDGE CARPET—

TAVOLO DINING OVALE—  
BASAMENTO E PIANO  
LACCATO LUCIDO  
ALMOND WHITE  
SEDIE JANET—  
505 UP SIDEBOARD—  
TAPPETO EDGE—





MATEO —

OVAL DINING TABLE—  
COFFEE OAK  
BASE AND TOP  
JANET CHAIRS—

TAVOLO DINING OVALE—  
BASAMENTO E PIANO  
ROVERE CAFFÈ  
SEDIE JANET—





MATEO —

ROUND DINING TABLE  
WITH LAZY SUSAN—  
BURNISHED MATT  
LACQUER BASE,  
CALACATTA MARBLE TOP  
PORTA VOLTA CHAIRS—  
STRIPE CARPET—

TAVOLO DINING ROTONDO  
CON LAZY SUSAN—  
BASAMENTO  
LACCATO OPACO BRUNITO,  
PIANO MARMO CALACATTA  
SEDIE PORTA VOLTA—  
TAPPETO STRIPE—



MATEO —

OVAL DINING TABLE—  
PEWTER GLOSSY LACQUER  
BASE AND TOP  
JANET CHAIRS—  
AURA CARPET—

TAVOLO DINING OVALE—  
BASAMENTO E PIANO  
LACCATO LUCIDO PELTRO  
SEDIE JANET—  
TAPPETO AURA—



MATEO —

ROUND DINING TABLE—  
PINE GREEN GLOSSY LACQUER  
BASE AND TOP  
JANET CHAIRS—  
PALETTE CARPET—

ROUND DINING TABLE—  
SUNRISE OAK BASE,  
CALACATTA MARBLE TOP

TAVOLO DINING ROTONDO—  
BASAMENTO E PIANO  
LACCATO LUCIDO PINE GREEN  
SEDIE JANET—  
TAPPETO PALETTE—

TAVOLO DINING ROTONDO—  
BASAMENTO ROVERE SUNRISE,  
PIANO MARMO CALACATTA



MATEO —

ROUND DINING TABLE—  
BURGUNDY GLOSSY LACQUER  
BASE AND TOP  
DUNA CARPET—

TAVOLO DINING ROTONDO—  
BASAMENTO E PIANO  
LACCATO LUCIDO BORGOGNA  
TAPPETO DUNA—





MATEO —

ROUND LOUNGE TABLE—  
COFFEE OAK  
BASE AND TOP  
PORTA VOLTA CHAIRS—

TAVOLO LOUNGE ROTONDO—  
BASAMENTO E PIANO  
ROVERE CAFFÈ  
SEDIE PORTA VOLTA—



MATEO —

ROUND LOUNGE TABLE  
WITH LAZY SUSAN—  
BURNISHED MATT  
LACQUER BASE,  
CALACATTA MARBLE TOP  
PORTA VOLTA CHAIRS—

TAVOLO LOUNGE ROTONDO  
CON LAZY SUSAN—  
BASAMENTO  
LACCATO OPACO BRUNITO,  
PIANO MARMO CALACATTA  
SEDIE PORTA VOLTA—



MATEO —

ROUND LOUNGE TABLE—  
BURNISHED MATT  
LACQUER BASE,  
CALACATTA MARBLE TOP  
PORTA VOLTA CHAIR—  
ATALANTE CARPET—

TAVOLO LOUNGE ROTONDO—  
BASAMENTO  
LACCATO OPACO BRUNITO,  
PIANO MARMO CALACATTA  
SEDIA PORTA VOLTA—  
TAPPETO ATALANTE—



# ARC

FOSTER + PARTNERS

A sculptural table, inspired by the technostructures. Un tavolo scultura che ripropone le forme delle  
The table Arc embodies the innovative concepts tensostrutture. Il tavolo Arc incorpora diversi concetti  
which distinguish it. The base shape is inspired by the innovativi che lo distinguono. La forma del basamento  
technostructures currently used in modern building: a si ispira alle tecnostrutture spesso utilizzate nei moderni  
new "light" cement which mixes colour and a special edifici, il materiale utilizzato: un nuovo cemento  
fibrous material obtaining resistant structures with a "leggero" che nel suo impasto incorpora, il colore ed  
low specific weight. Arc is available with round and uno speciale materiale fibroso che permette di ottenere  
oval tops which come in glass or in marble. strutture resistenti caratterizzate da un basso peso  
specifico. Arc è disponibile con piani rotondi e ovali  
in vetro o in marmo.





ARC —

TAVOLO—  
BRONZE BASE,  
SMOKED GLASS TOP  
OUTLINE CHAIRS—  
ROADS CARPET—

TAVOLO—  
BASAMENTO BRONZO,  
PIANO VETRO FUMÉ  
SEDIE OUTLINE—  
TAPPETO ROADS—



ARC —

TABLE—  
BLACK BASE,  
BLACK MARQUINA MARBLE TOP  
OUTLINE CHAIRS—  
SIRIA S1291 LEATHER  
GRADUATE BOOKCASE—  
SUPPORTING TOP-SHELF AND SHELVES  
BLACK ALUMINIUM

TAVOLO—  
BASAMENTO NERO,  
PIANO MARMO NERO MARQUINA  
SEDIE OUTLINE—  
PELLE SIRIA S1291  
LIBRERIA GRADUATE—  
PIANO DI SOSTEGNO E RIPIANI  
ALLUMINIO NERO



ARC —

OVAL TABLE—  
BRONZE BASE,  
EXTRALIGHT GLASS TOP  
JANET CHAIRS—  
EUCALYPTUS STRUCTURE  
SIRIA S1230 LEATHER  
LOGOS SYSTEM—  
STRIPE CARPET—

TAVOLO OVALE—  
BASAMENTO BRONZO,  
PIANO VETRO EXTRACHIARO  
SEDIE JANET—  
STRUTTURA EUCALIPTO  
PELLE SIRIA S1230  
SISTEMA LOGOS—  
TAPPETO STRIPE—



# GATWICK

RODOLFO DORDONI

This table, designed by Milanese architect Rodolfo Dordoni, takes the name of London's Gatwick airport, one of the busiest in the world. A hub where cosmopolitan travellers meet every hour of the day and night on their way in or out of the U.K. capital, much like a table where people meet for dinner. It is the particular structure of twisted and criss-cross steel recalling an airplane propeller or a helicopter blade that inspired the name. The aluminium frame in several contemporary finishes, such as black nickel, pewter colour (satin finish) and iris (satin finish), supports elegant oval tops of different sizes enriched with wood or marble, selected from the Molteni&C collection.

Questo progetto di tavolo, dell'architetto milanese Rodolfo Dordoni, prende il nome da uno degli aeroporti londinesi più trafficati al mondo. Un Hub dove viaggiatori cosmopoliti si incontrano ogni ora del giorno e della notte diretti verso la capitale del Regno Unito o per partirci, similamente ad un tavolo dove ci si incontra per cenare. È la particolare struttura in alluminio ritorta e incrociata a ricordare un'elica o una pala d'elicottero che ne ha ispirato il nome. La struttura in alluminio, in diverse finiture contemporanee come il nickel nero, il peltro (satinato) e l'iris (satinato), sostiene eleganti piani ovali di diverse dimensioni impreziosite dalla presenza di essenza o marmo, tratti dalla collezione Molteni&C.

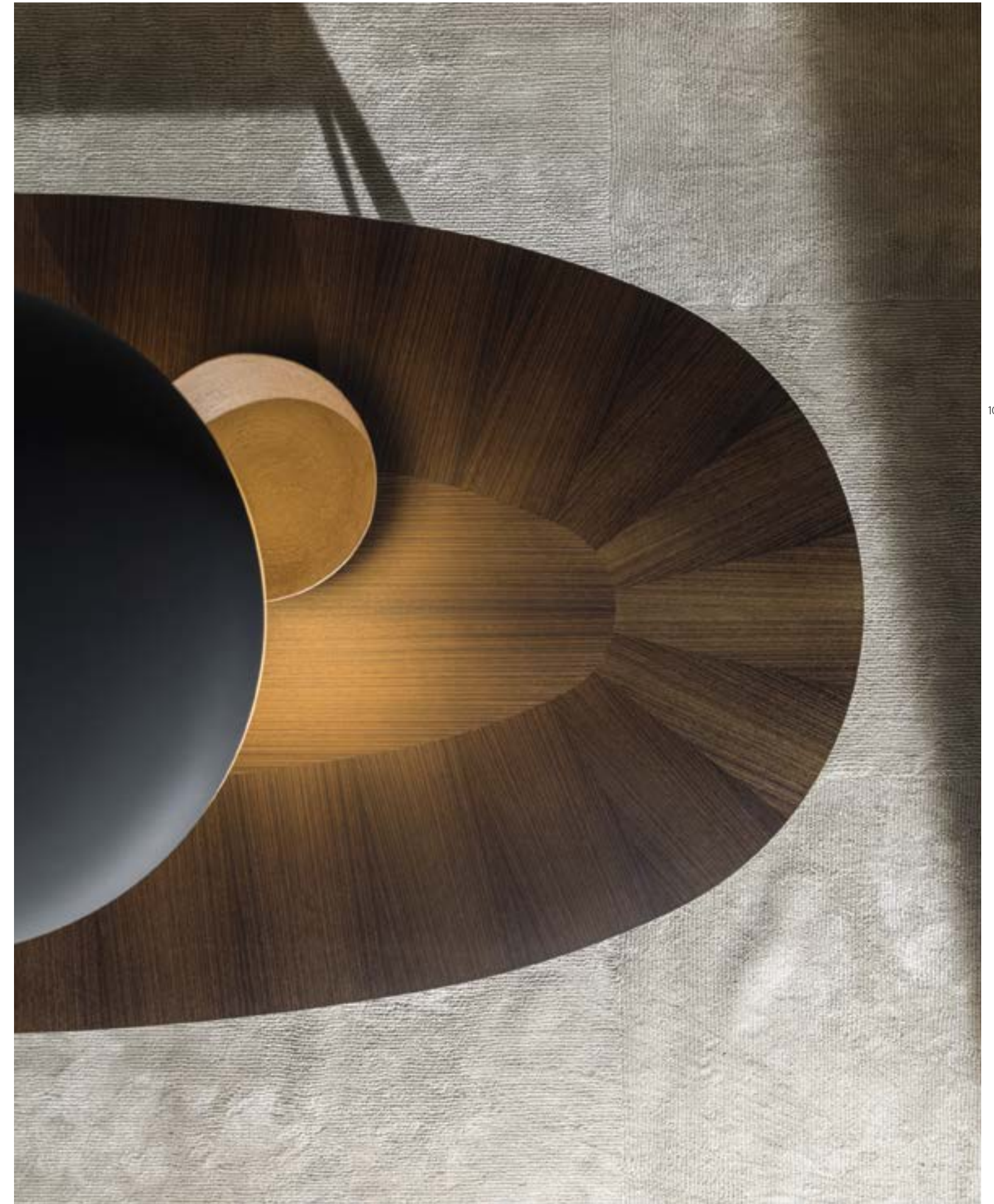

GATWICK —

TABLE—  
PEWTER COLOUR SATIN  
FINISH STRUCTURE,  
EUCALYPTUS TOP  
TEA CHAIRS—  
PASS-WORD EVOLUTION—  
STRIPE CARPET—

TAVOLO—  
STRUTTURA  
PELTRO SATINATO,  
PIANO EUCALIPTO  
SEDIE TEA—  
PASS-WORD EVOLUTION—  
TAPPETO STRIPE—





GATWICK —

TABLE—  
PEWTER COLOUR SATIN  
FINISH STRUCTURE,  
SAHARA NOIR MARBLE TOP  
WOODY CHAIRS—  
BLACK OAK STAINED ASH

TAVOLO—  
STRUTTURA  
PELTRO SATINATO,  
PIANO MARMO SAHARA NOIR  
SEDIE WOODY—  
FRASSINO TINTO ROVERE NERO



# AVA TABLE

FOSTER + PARTNERS

True to their policy of designing eco-friendly buildings and furnishings, Foster + Partners have come up with a set of tables for contemporary settings. Made entirely of wood, the natural material par excellence, the Ava Table responds to the ever-increasing need for designer furniture to meet the demand for ecosustainability without forgoing the need to represent the space that every piece of furniture deserves. With its characteristic T-shaped legs, placed in a rear position with respect to the top so as to maximise its useful capacity, the table is all-one with the top, giving rise to an object that is at once compact but light in form. The skillful use of materials, combined with refined construction details, underlines the style dear to Foster+ Partners: furniture defined by its stunning formal lightness. The table comes in various sizes and the external finishes are all strictly made of quality wood veneers.

Fedele alla filosofia volta a progettare edifici e arredi rispettosi dell'ambiente, Foster + Partners progettano una serie di tavoli per ambienti contemporanei. Monomaterico, realizzato interamente in legno, materiale naturale per eccellenza e molto facilmente riciclabile, il tavolo Ava Table dà risposta al bisogno sempre più presente, nell'ambito dell'arredo di design, di soddisfare esigenze di eco sostenibilità non sacrificando il bisogno di rappresentazione dello spazio che ogni arredo deve meritarsi. Il tavolo con la sua caratteristica gamba a T svasata e posta in posizione arretrata rispetto al piano per massimizzare la sua capacità ricettiva, si raccorda senza soluzione di continuità al piano dando luogo ad un elemento compatto ma leggero nella forma. Sapiente uso dei materiali abbinati a raffinati dettagli costruttivi evidenziano il segno stilistico caro allo studio Foster + Partners al fine di ottenere arredi dotati di grande leggerezza formale. Diverse le misure disponibili e i rivestimenti esterni tutti rigorosamente in pregiata essenza.



AVA TABLE —

AVA TABLE—  
WALNUT STRUCTURE AND TOP  
BARBICAN CHAIRS—  
EUCALYPTUS STRUCTURE  
UNIQUE UE134 LEATHER SHELL  
WILUNA WF536 SEAT  
PASS-WORD EVOLUTION—  
MOKA MATT LACQUER STRUCTURE  
PEWTER FEET  
STRIPE CARPET—

TAVOLO AVA TABLE—  
STRUTTURA E PIANO NOCE  
SEDIE BARBICAN—  
STRUTTURA EUCALIPTO  
SCOCCA PELLE UNIQUE UE134  
SEDUTA WILUNA WF536  
PASS-WORD EVOLUTION—  
STRUTTURA LACCATO MOKA OPACO  
PIEDINI PELTRO  
TAPPETO STRIPE—





# OLD FORD

RODOLFO DORDONI

The Old Ford table by the Italian designer Rodolfo Dordoni is a perfect embodiment of a commitment by Molteni&C in combining aesthetics, functionality, and technical innovation. The table is composed of a rounded, lozenge-shaped top that curves downward on the underside to meet four glossy lacquered legs connected by an H-shaped beam. The finely worked top is available with the choice of coffee oak wood finish, and in emperador dark, calacatta and sahara noir marble in in matt and glossy polyester version, giving it a warm and inviting appearance. The table under-top resembles a shell composed of soft lines. The contrasting-coloured legs are available in three glossy lacquered finishes, burgundy, pine green, and black nickel. The table's supportive frame is made using hydroforming, a sophisticated process commonly used in the automotive industry that uses water pressure to give shape to the material. This process allows the table to be lightweight yet strong and structurally rigid, ensuring that it can withstand the test of time. The oval shape also allows the table to fit into various room layouts, making it a versatile option for any home.

Il tavolo Old Ford del designer italiano Rodolfo Dordoni incarna perfettamente l'impegno di Molteni&C nel coniugare estetica, funzionalità e innovazione tecnica. Il tavolo è composto da un piano arrotondato e sinuoso, con una sezione raccordata agli estremi che incontra un solido basamento lucido caratterizzato dal collegamento delle gambe ad una struttura ad H. Il top finemente lavorato è disponibile nelle finiture rovere caffè e marmo emperador dark, calacatta, sahara noir in versione opaca e poliestere lucida che gli conferiscono un aspetto caldo e invitante. Il corpo inferiore del tavolo ricorda un guscio, caratterizzato da linee morbide. Le gambe, a contrasto, sono disponibili in tre finiture laccate lucide in pine green, rosso borgogna e nickel nero. La struttura portante del tavolo è realizzata mediante la tecnica dell'idroformatura, un sofisticato processo comunemente utilizzato nel settore industriale della mobilità, che sfrutta la pressione dell'acqua per plasmare la materia. Questo processo consente al tavolo di essere leggero ma strutturalmente rigido, garantendo la resistenza nel tempo. La forma ovale consente inoltre al tavolo di adattarsi a svariati layout d'interni, rendendolo un'opzione versatile per qualsiasi casa.



OLD FORD —

TABLE—  
GLOSSY BLACK NICKEL  
STRUCTURE,  
COFFEE OAK TOP  
PORTA VOLTA CHAIR—  
EDGE CARPET—

TAVOLO—  
STRUTTURA  
NICKEL NERO LUCIDO,  
PIANO ROVERE CAFFÈ  
SEDIA PORTA VOLTA—  
TAPPETO EDGE—



OLD FORD —

TABLE—  
GLOSSY PINE GREEN  
STRUCTURE,  
CALACATTA MARBLE TOP  
PORTA VOLTA CHAIRS—  
AURA CARPET—

TAVOLO—  
STRUTTURA  
PINE GREEN LUCIDO,  
PIANO MARMO CALACATTA  
SEDIE PORTA VOLTA—  
TAPPETO AURA—





# ASTERIAS

PATRICIA URQUIOLA

Asterias a generously-sized round table, featuring a central base reminiscent of the cactus from which it takes its name. It consists of six curved, wedge-shaped, panels, applied protruding over the central plinth. The wooden panels are 3D printed. The top (Ø 160 or 180 cm) features a rounded edge subdivided, into four wedges that give rise to an interesting geometric pattern. Asterias can also be fitted with a practical accessory: a central Lazy Susan turntable. very popular in Asian countries. The table is available in wood, graphite Oak, Sunrise Oak and Eucalyptus.

Asterias, un tavolo rotondo dalle dimensioni generose, caratterizzato da una base centrale che ricorda il cactus da cui prende il nome. È, infatti, composta da sei pannelli in curvati, a forma di spicchio, applicati a sbalzo sul plinto centrale. I pannelli in essenza sono realizzati con la particolare tecnica dello stampaggio 3D. Il piano (Ø 160 o 180 cm), dal bordo arrotondato, è suddiviso in quattro spicchi che danno luogo a un interessante disegno geometrico. Asterias dispone inoltre di un pratico accessorio: un piatto girevole centrale (Lazy Susan), molto apprezzato nei paesi asiatici. Il tavolo è disponibile in essenza, Rovere grafite, Rovere Sunrise e Eucalipto.



ASTERIAS —

TABLE—  
GRAPHITE OAK  
TOP, BASE AND  
LAZY SUSAN  
GLOVE-UP CHAIRS—

TAVOLO—  
PIANO, BASAMENTO,  
PIATTO GIREVOLE  
ROVERE GRAFITE  
SEDIE GLOVE-UP—





ASTERIAS —

TABLE—  
GRAPHITE OAK  
TOP, BASE AND  
LAZY SUSAN  
GLOVE-UP CHAIRS—

TAVOLO—  
PIANO, BASAMENTO,  
PIATTO GIREVOLE  
ROVERE GRAFITE  
SEDIE GLOVE-UP—

ASTERIAS —

TABLE—  
EUCALYPTUS  
BASE AND TOP  
MHC.3 MISS CHAIR—  
HEM CARPET—

TABLE WITH  
CENTRAL TURNTABLE—  
SUNRISE OAK  
BASE AND TOP

TAVOLO—  
BASAMENTO E PIANO  
EUCALIPTO  
SEDIA MHC.3 MISS—  
TAPPETO HEM—

TAVOLO CON  
PIATTO GIREVOLE—  
BASAMENTO E PIANO  
ROVERE SUNRISE





# HALF A SQUARE

MICHAEL ANASTASSIADES

The project is very minimalist in design but rich in materials, such as aluminium and marble. The structural frame, made of satin-finished extruded aluminium painted pewter and green, is assembled using sturdy die-cast legs. The combination of the parts results in a triangular shape with a brass finish that encompasses its distinctive aesthetics of elegance and design. The tops are in marble. Available in various rectangular and square sizes. In this project, Anastassiades' engineering background nearly eclipses his design background, leading to a unique and intriguing object.

Il progetto è fortemente minimalista nel disegno ma ricco nei materiali utilizzati come alluminio e marmo. Il telaio strutturale, realizzato con estrusi di alluminio satinati e verniciati color peltro e verde, è assemblato mediante le robuste gambe pressofuse. La giunzione tra le parti, determina una geometria triangolare in finitura ottone che riassume la particolarità estetica, caratterizzandone l'eleganza e il design. I piani sono in marmo. Proposto in diverse dimensioni rettangolari e quadrati. Un progetto dove la formazione ingegneristica di Anastassiades, prende quasi il sopravvento su quella di designer per regalarci un oggetto unico ed intrigante.



HALF A SQUARE —

TABLE—  
PEWTER COLOUR SATIN  
FINISH STRUCTURE,  
GREEN ALPINE MARBLE TOP  
TEA CHAIRS—

TAVOLO—  
STRUTTURA  
PELTRO SATINATO,  
PIANO IN MARMO VERDE ALPI  
SEDIE TEA—





HALF A SQUARE —

TABLE—  
GREEN SATIN FINISH STRUCTURE,  
GREEN ALPINE MARBLE TOP  
BARBICAN CHAIRS—  
EUCALYPTUS BASE,  
L216 LEATHER  
PALETTE CARPET—

TAVOLO—  
STRUTTURA VERDE SATINATO,  
PIANO MARMO VERDE ALPI  
SEDIE BARBICAN—  
BASAMENTO EUCALIPTO,  
PELLE L216  
TAPPETO PALETTE—





HALF A SQUARE —

TABLE—  
PEWTER COLOUR SATIN  
FINISH STRUCTURE,  
GREEN ALPINE MARBLE TOP  
DEVON CHAIRS—  
BLACK OAK BASE, EXTRA L162 LEATHER  
VIBRAZIONI CARPET—

TAVOLO—  
STRUTTURA PELTRO SATINATO,  
PIANO MARMO VERDE ALPI  
SEDIE DEVON—  
BASAMENTO ROVERE NERO,  
PELLE L162  
TAPPETO VIBRAZIONI—



HALF A SQUARE —

TABLE—  
GREEN SATIN FINISH STRUCTURE,  
GREEN ALPINE MARBLE TOP  
AND STRUCTURE—  
DEVON CHAIRS—  
BLACK OAK BASE,  
KAOS K08CS  
AURA CARPET—

TAVOLO—  
STRUTTURA VERDE SATINATO,  
PIANO MARMO VERDE ALPI  
BIANCO CALCE—  
SEDIE DEVON—  
BASAMENTO ROVERE NERO,  
KAOS K08CS  
TAPPETO AURA—



WORK IS NOT PLAY, PLAY IS NOT WORK, NOT EVERYTHING CAN BE FORESEEN IN THE LIFE OF A HOME OR THE REQUIREMENTS OF ITS INHABITANTS. BUT TODAY THE TOOLS OF PLAY AND THOSE OF WORK, THOSE THAT INFORM AND THOSE THAT COMMUNICATE, ARE ONE AND THE SAME. NOT EVERYTHING CAN BE FORESEEN IN THE LIFE OF FURNITURE, BUT GOOD FURNITURE WILL ACCOMMODATE DIFFERENT OBJECTS AND INSTRUMENTS AND WILL ADAPT TO THE MATERIAL PROBLEMS AND THE SPIRIT OF THE HOME'S INHABITANTS.

IL LAVORO NON È UN GIOCO, IL GIOCO NON È UN LAVORO, NON TUTTO PUÒ ESSERE PREVISTO NELLA VITA DELLE CASE E NELLE ESIGENZE DELLE PERSONE. MA OGGI ACCADE CHE GLI STRUMENTI DEL GIOCO E QUELLI DEL LAVORO, QUELLI PER INFORMARSI E QUELLI PER COMUNICARE, SI IDENTIFICHINO E CONFONDANO. NON TUTTO PUÒ ESSERE PREVISTO NELLA VITA DI UN MOBILE, MA UN BUON MOBILE DEVE POTER ACCOGLIERE OGGETTI E STRUMENTI DIVERSI, DEVE POTERSI ADATTARE AI PROBLEMI MATERIALI E ALLO SPIRITO DI CHI ABITA LA CASA.

home  
office



## D.847.1

GIO PONTI

1945 marked the end of the Second World War and the problem of converting war productions into "peace" productions immediately arose in order to restart economic activity. Gio Ponti made contact with an important aircraft manufacturer who owned a factory specialising in the manufacture of gliders. Wood and cloth are, together with great craftsmanship, the most commonly used raw materials. It is, therefore, natural to move into the production of furniture and, as it happens, also wooden toys. In 1947 Gio Ponti designed a "bedroom for a bachelor", presented first at the Galleria del Sagrato, then at the RIMA - Riunione Italiana Mostre per l'Arredamento - at the Triennale, both in Milan, and finally at the XVI International Exhibition in Barcelona in '48. More than 70 years after its original design, the D.847.1 console table is reborn thanks to the Heritage Collection reissue project by Molteni&C, in collaboration with the Gio Ponti Archives. As with all the projects in the Heritage Collection, careful study of drawings, photos and period materials has made it possible to faithfully reproduce the D.847.1 desk in all its details, bringing to light a masterpiece, inspired by the high level of craftsmanship in solid wood processing.

Il 1945 segna la fine del II conflitto mondiale e subito si pone il problema di convertire produzioni belliche in produzioni "di pace" per far ripartire l'attività economica. Gio Ponti entra in contatto con un importante costruttore aeronautico che possiede una fabbrica specializzata in fabbricazione di alianti. Il legno e la tela sono, insieme a una grande capacità artigianale, le materie prime più utilizzate. È naturale, quindi, passare alla produzione di mobili e, guarda caso, anche di giocattoli in legno. Nel 1947 Gio Ponti progetta una "camera da letto per uno scapolo", presentata prima alla Galleria del Sagrato, poi alla RIMA - Riunione Italiana Mostre per l'Arredamento - presso la Triennale, entrambe a Milano, e infine alla XVI Mostra Internazionale di Barcellona nel '48. Dopo oltre 70 anni dal progetto originale, la consolle D.847.1 rinasce grazie al progetto di riedizioni Heritage Collection di Molteni&C, in collaborazione con i Gio Ponti Archives. Come per tutti i progetti della collezione Heritage, lo studio attento di disegni, foto e materiali d'epoca ha permesso di riprodurre fedelmente lo scrittoio D.847.1 in tutti i dettagli, riportando alla luce un capolavoro, dettato dall'alta artigianalità della lavorazione del massello.

### HERITA- GE COL- LECTION







D.847.1—

WRITING DESK—  
HONEY STAINED ASH  
WOOD STRUCTURE,  
SATIN BRASS FEET

SCRITTOIO—  
STRUTTURA  
FRASSINO TINTO MIELE,  
PIEDI OTTONE SATINATO



# ARIA

VINCENT VAN DUYSSEN

The Aria writing desk, with its clean lines and minimalist aesthetic, stands out for its timeless elegance. Characterized by a sheet folded at both ends, the design expresses extreme purity, enhanced by the top surface covered in Eco Skin, available in two colours of the Molteni&C collection (ivory and earth). Painted steel structure characterized by lightness and strength, ensuring durability and solidity over time. The lower part, tapered along the entire perimeter, is made of solid wood painted in open-pore black. Inside, a small pull-out drawer provides the perfect space to store precious items. A versatile writing desk with ideal dimensions for seamless integration into any context, including domestic environments.

Lo scrittoio Aria, dalle linee nitide e dall'estetica purista, si distingue per la sua eleganza senza tempo. Il design, caratterizzato da un foglio ripiegato ai due estremi, esprime una purezza estrema, impreziosita dalla superficie superiore rivestita in materiale Eco Skin, disponibile in due colori della collezione Molteni&C (avorio e terra). Struttura in acciaio verniciato caratterizzata da leggerezza e resistenza, garanzia di solidità e durata nel tempo. La parte inferiore, rastremata lungo tutto il perimetro, è realizzata in massello di legno verniciato nero a poro aperto. Al suo interno, un piccolo cassetto estraibile offre uno spazio perfetto per custodire oggetti preziosi. Scrittoio dal design versatile e dalle dimensioni ideali per un'integrazione armoniosa in qualsiasi contesto, inclusi ambienti domestici.





ARIA —

WRITING DESK—  
IVORY ECO SKIN  
UPPER COVER  
MONK CHAIR—  
ORIZZONTI CARPET—

SCRITTOIO—  
RIVESTIMENTO SUPERIORE  
ECO SKIN AVORIO  
SEDLIA MONK—  
TAPPETO ORIZZONTI—



ARIA —

WRITING DESK—  
IVORY ECO SKIN  
UPPER COVER  
MONK CHAIR—  
ORIZZONTI CARPET—

SCRITTOIO—  
RIVESTIMENTO SUPERIORE  
ECO SKIN AVORIO  
SEDIA MONK—  
TAPPETO ORIZZONTI—

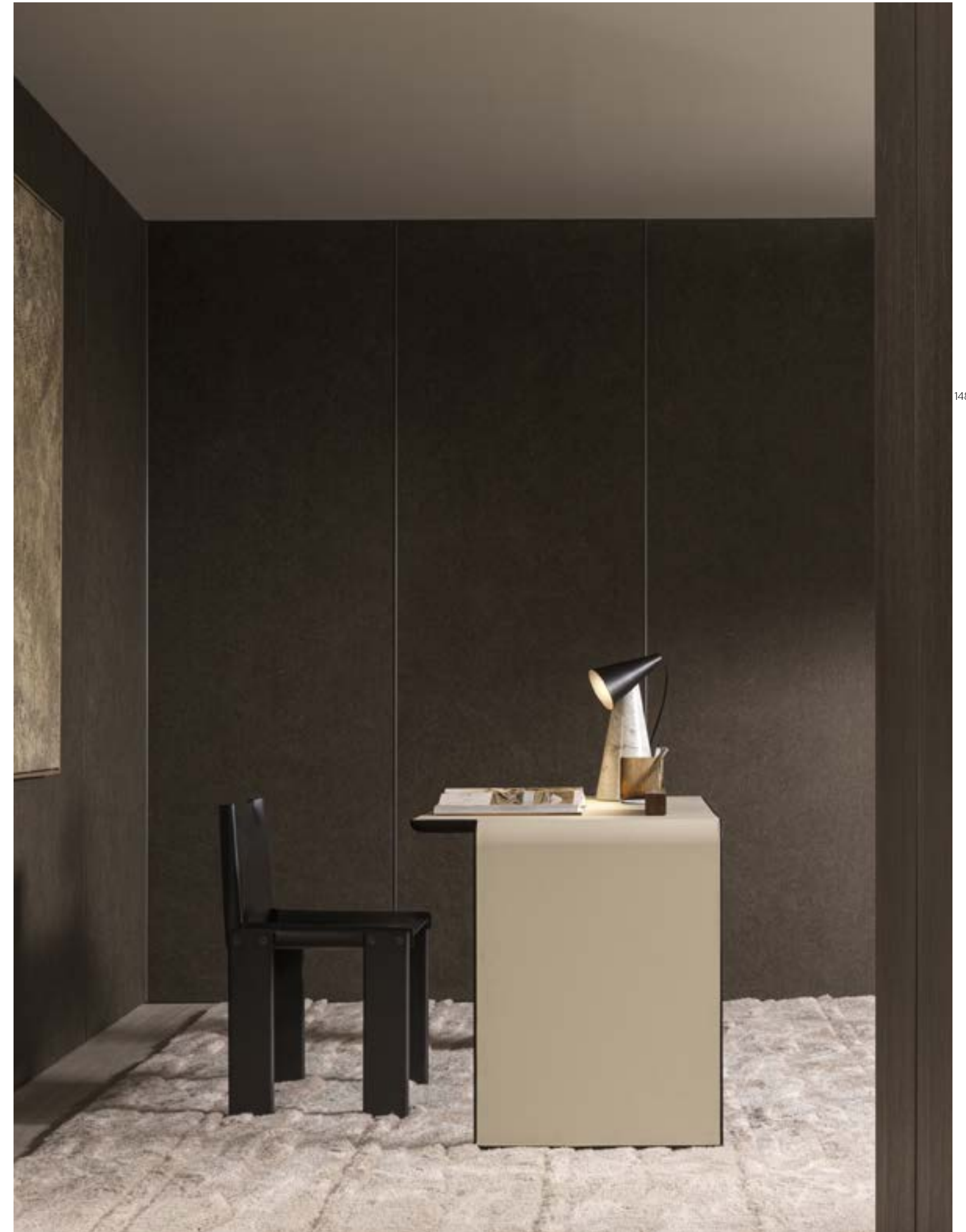

# LESSLESS

JEAN NOUVEL

LessLess is a complete range of tables, rectangular and square, lacquered in different colours. An aluminium structure the strength of which lies in a play on corners and folds. The external outline of the horizontal table top is very thin and stiffness and it is obtained by bending the aluminium sheet along inclined planes. Designed originally for the Fondation Cartier in Paris, the LessLess tables stand out for intrinsic elegance and light lines in every environment.

LessLess è una famiglia completa di tavoli, rettangolari e quadrati, laccati in diversi colori. Una struttura in alluminio, la cui resistenza è tutta affidata ad un gioco di spigoli e pieghe. Il profilo esterno del piano orizzontale è sottilissimo e la rigidità è ottenuta piegando la lamiera di alluminio secondo piani inclinati. Disegnati originariamente per la Fondation Cartier a Parigi, i tavoli LessLess rivelano la loro estrema eleganza e leggerezza in ogni ambiente.



LESSLESS —

TABLE—  
CHALK WHITE MATT LACQUER  
MONTECATINI D.235.1 CHAIR—  
POLISHED ALUMINIUM

TAVOLO—  
LACCATO OPACO BIANCO CALCE  
SEDLIA MONTECATINI D.235.1—  
ALLUMINIO LUCIDATO



## NOTE

MATTEO NUNZIATI

This desk is the result of the desire to create a contemporary product with essential characteristics and very refined aesthetic and technical details that demonstrate the woodworking expertise that Molteni&C. is devoted to maintaining. The top, positioned asymmetrically on the structure, has two trays carved into its wood surface, and the central tray is covered in hide leather. The wood on the rear is made with a pronounced curved shape that allows it to hold small drawers, which are also covered in hide leather. The legs are made with a complex three-dimensional woodworking technique in which grooves are carved into three sides of the piece. The resulting product shows a good balance of essential style and elegance, simultaneously modern and linear while also refined and rich in expert cabinet-making details.

Il progetto nasce dalla volontà di creare un prodotto contemporaneo ma essenziale, molto ricercato nei dettagli estetici e tecnici, che esaltano tutta la maestria della lavorazione del legno tanto cara a Molteni&C. Il piano di scrittura, posizionato assimetricamente, rispetto alla struttura, è dotato di due vassoi scavati direttamente nel piano stessi, di cui quello centrale ha un rivestimento in cuoio. La parte posteriore è caratterizzata da un pronunciata curvatura del legno che permette l'alloggiamento di piccoli cassetti rivestiti anch'essi in cuoio. Le gambe, realizzate grazie ad una complessa tecnica di lavorazione tridimensionale del legno, sono scavate su tre lati. Il risultato è un prodotto in equilibrio tra essenzialità ed eleganza, un prodotto moderno e lineare ma allo stesso tempo raffinato e ricco di dettagli di alta ebanisteria.





NOTE —

WRITING DESK—  
AMERICAN WALNUT  
STRUCTURE AND TOP,  
DARK BROWN BONDED HIDE LEATHER  
MHC.3 MISS CHAIR—  
ASH WOOD STAINED BLACK,  
L200 LEATHER

SCRITTOIO—  
STRUTTURA E PIANO  
NOCE CANALETTO,  
CUIO RIGENERATO TESTA DI MORO  
SEDA MHC.3 MISS—  
FRASSINO TINTO NERO,  
PELLE L200





# SCRIBA

PATRICIA URQUIOLA

A writing desk with very clean lines and a decoratively perforated top support element that conveys a sense of lightness. Wood tops, a practical side drawer and a clever bookshelf support element in lacquered sheet metal complete the desk.

Uno scrittoio dalle nitide linee dove, l'elemento di sostegno del piano di scrittura, si caratterizza per la leggerezza data dal decoro traforato. Piani in legno, un pratico cassetto laterale e un ingegnoso supporto reggilibri in lamiera laccata completano lo scrittoio.



SCRIBA —

WRITING DESK—  
EUCALYPTUS,  
DOLOMITE GREY MATT LACQUER  
MHC.3 MISS CHAIR—  
ASH WOOD STAINED BLACK  
L209 LEATHER  
HEM CARPET—

SCRITTOIO—  
EUCALIPTO,  
LACCATO OPACO DOLOMITE  
SEDIA MHC.3 MISS—  
FRASSINO TINTO NERO  
PELLE L209  
TAPPETO HEM—



# TOUCH DOWN UNIT

## STUDIO KLASS

Touch Down Unit, an innovative workstation designed by Studio Klass and originally thought for advanced work environments and produced by UniFor (a Molteni Group company), has become part of the Molteni&C collection in its new home version. TDU, enhanced by a series of new and more homely finishes, has been reinterpreted and conceived as an autonomous, discreet workstation. A safe place where to leave the necessary equipment to carry out your activity, may it be just sending an email or checking your schedule, thus becoming an object designed to meet individual requirements which changes and comes to life as a space for your personal items. The Touch Down Unit is discreet, autonomous and multitasking, allowing you to work from a chair, sofa, stool, or from a standing position, thus ensuring your physical wellbeing and adapting to any space.

Touch Down Unit l'innovativa workstation, design Studio Klass, pensata in origine per ambienti di lavoro evoluti e prodotta da UniFor (azienda del Gruppo Molteni), nella nuova versione home entra a far parte della collezione Molteni&C. TDU arricchito anche da una serie di nuove finiture più vicine al mondo della casa, viene riletto e pensato come una postazione intima, personale, un nido dove lasciare e ritrovare i propri strumenti per svolgere un certo tipo di attività, dal mandare una mail al consultare la propria agenda, diventando quindi un oggetto cucito sulla persona, mutando e prendendo vita insieme ai suoi oggetti ed effetti personali. Touch Down Unit è discreto, autonomo e multitasking, permette di lavorare da sedia, divano, sgabello, oppure stando in piedi garantendo così il benessere fisico e adattandosi ad ogni spazio.

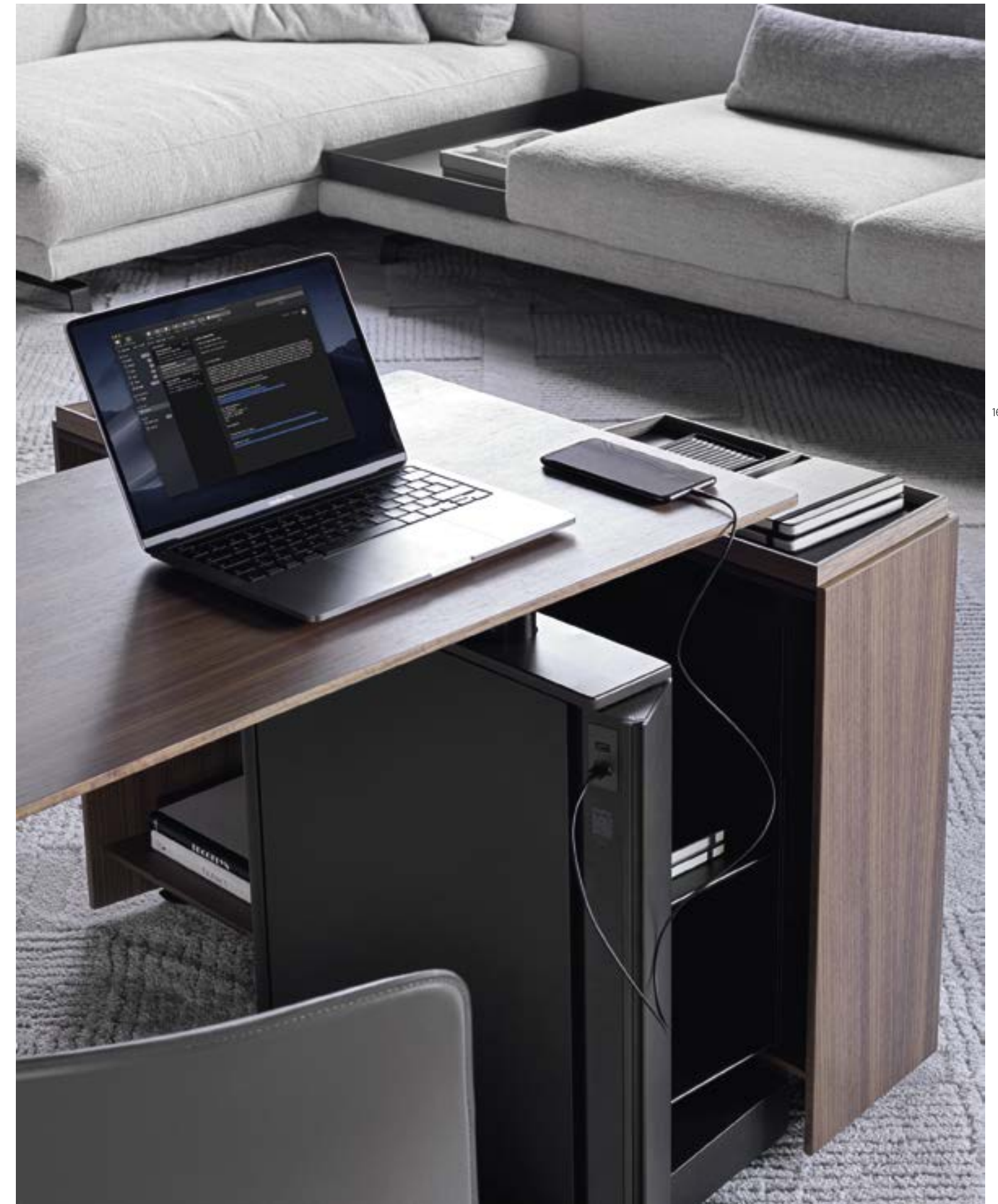

TOUCH DOWN UNIT —

WORKSTATION—  
AMERICAN WALNUT TOP  
AND EXTERNAL SHELL BRONZE  
LACQUER CENTRAL BODY  
ARMCHAIRS—  
WALTER  
CHAIRS—  
BARBICAN

POSTAZIONE DA LAVORO—  
TOP NOCE CANALETTO CORPO  
CENTRALE VERNICIATO BRONZO  
FINITURA UNIFORME  
POLTRONE—  
WALTER  
SEDIE—  
BARBICAN





TOUCH DOWN UNIT —

WORKSTATION—  
 SHELL AND WORKTOP IN UNIFOR  
 AMERICAN WALNUT FINISH  
 CENTRAL BODY PAINTED BRONZE  
 BARBICAN—  
 PAINTED PEWTER COLOUR FINISH BASE  
 MUD GREEN BONDED HIDE  
 LEATHER SHELL

POSTAZIONE DA LAVORO—  
 GUSCIO E TOP NOCE CANALETTO  
 FINITURA UNIFOR  
 CORPO CENTRALE VERNICIATO BRONZO  
 BARBICAN—  
 BASAMENTO VERNICIATO  
 PELTRO  
 SCOCCA CUIO VERDE FANGO



SITTING ROUND A TABLE IS A RITUAL, AN EVERYDAY WAY OF COMING TOGETHER. TABLES AND CHAIRS PROVIDE THE BEATING HEART OF A HOME AROUND WHICH FURNITURE AND STORAGE UNITS, PLUS THEIR CONTENTS, ARE ARRANGED. CHAIRS ARE AWKWARD: THEY HAVE TO SUPPORT BODYWEIGHT WHILE TAKING SIZE, MOVEMENTS AND POSTURE INTO ACCOUNT. IT FOLLOWS THAT NOT ALL ITEMS OF FURNITURE CAN MATCH IN SHAPE OR STYLE BECAUSE THEY HAVE TO SATISFY A VARIETY OF USES.

SEDESI ATTORNO AD UN TAVOLO È UN ATTO RITUALE, PICCOLA CERIMONIA QUOTIDIANA DELL'INCONTRO. TAVOLO E SEDIA SONO IL NUCLEO GENERATORE DELLA CASA ATTORNO AL QUALE SI DISPONGONO MOBILI E CONTENITORI IN CUI RACCOLGERE ORDINATAMENTE GLI OGGETTI E GLI STRUMENTI DI OGNI GIORNO. LA SEDIA È UN OGGETTO DIFFICILE: DEVE REGGERE IL PESO DEL CORPO TENENDO CONTO DELLE SUE FORME, DEI MOVIMENTI, DELLE POSTURE. PER QUESTO I MOBILI NON POSSONO OBBEDIRE A UNA SCELTA UNIVOCA DI FORMA O DI STILE, MA DEVONO CORRISPONDERE A TANTE POSSIBILITÀ DI IMPIEGO.

chairs



# MONK

TOBIA SCARPA

For 2025, Molteni&C proposes a re-edition of the iconic Monk chair, originally designed by Afra and Tobia Scarpa in 1973. Preserving the character of the original, Monk presents a solid wood frame (available in American walnut, black oak or coffee oak finishing) made of two equally-sized trestles attached to shaped metal tubing creating a single element for the seat and back. The two structural parts are joint by two pairs of special rings for each trestle, with the decorative touch of large hubs in burnished steel. The seat structure is made of two hide leather sections shaped for comfort and available in any color from the Molteni&C collection. Monk is also proposed in a lower and wider armchair version, designed to enhance any living space.

Nel 2025 Molteni&C propone una riedizione dell'iconica sedia Monk, disegnata da Afra e Tobia Scarpa nel 1973, preservandone il carattere originale. Monk presenta una struttura in legno massello come la versione originale, (disponibile nelle finiture noce canaletto, rovere nero o rovere caffè) composta da due cavalletti uguali in legno massello fissati a tubolari metallici sagomati che creano un unico elemento per la seduta e lo schienale. Le due parti strutturali sono unite da due paia di viti per ogni cavalletto, con un tocco decorativo dato da grandi anelli speciali in acciaio brunito. La struttura della seduta è composta da due parti in cuoio sagomate per garantire una seduta confortevole e disponibile in tutti i colori della collezione Molteni&C. Monk è anche proposta in una versione poltrona, più bassa e larga, progettata per valorizzare qualsiasi ambiente living.

**HERITA-**  
**GE COL-**  
**LECTION**



MONK —

CHAIRS—  
BLACK OAK STRUCTURE,  
BLACK HIDE LEATHER  
SEAT AND BACKREST  
DIAMOND TABLE—  
GRADUATE BOOKCASE—  
STRIPE CARPET—

SEDIE—  
STRUTTURA ROVERE NERO,  
SEDUTA E SCHIENALE  
CUOIO NERO  
TAVOLO DIAMOND—  
LIBRERIA GRADUATE—  
TAPPETO STRIPE—





MONK —

CHAIR—  
BLACK OAK STRUCTURE,  
BLACK HIDE LEATHER  
SEAT AND BACKREST—  
ARIA WRITING DESK—  
ORIZZONTI CARPET—

SEDIA—  
STRUTTURA ROVERE NERO,  
SEDUTA E SCHIENALE  
CUOIO NERO—  
SCRITTOIO ARIA—  
TAPPETO ORIZZONTI—





MONK —

CHAIR—  
AMERICAN WALNUT STRUCTURE,  
NATURAL HIDE LEATHER  
SEAT AND BACKREST  
LISE TABLE—  
EONE CARPET—

SEDIA—  
STRUTTURA NOCE CANALETTO,  
SEDUTA E SCHIENALE  
CUOIO NATURALE  
TAVOLO LISE—  
TAPPETO EONE—



MONK —

CHAIRS—  
AMERICAN WALNUT STRUCTURE,  
BLACK HIDE LEATHER  
SEAT AND BACKREST  
MAYLIS, FLEUR—  
COFFEE TABLES—  
LOGOS LIVING SYSTEM—  
PASS-WORD EVOLUTION  
SHELVES SYSTEM—  
RANDOM CARPET—

SEDIE—  
STRUTTURA NOCE CANALETTO,  
SEDUTA E SCHIENALE  
CUOIO NERO  
TAVOLINI  
MAYLIS, FLEUR—  
LIVING SYSTEM LOGOS—  
SISTEMA DI MENSOLE  
PASS-WORD EVOLUTION—  
TAPPETO RANDOM—



MONK —

CHAIRS—  
AMERICAN WALNUT STRUCTURE,  
HAZELNUT HIDE LEATHER  
SEAT AND BACKREST  
FILIGREE TABLE—  
TEOREMA DRAWER UNIT—  
ROADS CARPET—

SEDIE—  
STRUTTURA NOCE CANALETTO,  
SEDUTA E SCHIENALE  
CUOIO NOCCIOLA  
TAVOLO FILIGREE—  
CONTENITORE TEOREMA—  
TAPPETO ROADS—



MONK —

CHAIR—  
AMERICAN WALNUT STRUCTURE,  
HAZELNUT HIDE LEATHER  
SEAT AND BACKREST  
FILIGREE TABLE—  
ROADS CARPET—

SEDIA—  
STRUTTURA NOCE CANALETTO,  
SEDUTA E SCHIENALE  
CUOIO NOCCIOLA  
TAVOLO FILIGREE—  
TAPPETO ROADS—

## MHC.3 MISS

TOBIA SCARPA

The form is linked to a system of soft, unbroken, linear rhythms. The legs are slim and divaricated, to ensure stability. The front ones are bent to form the armrests and continue into the curve of the backrest. The back legs reach the backrest from behind, underpinning it. The seat is inserted between the lines and links them. Tobia Scarpa has re-designed the armrest joint to make the chair comfier and more linear. Structure in natural or black tinted ash, seat in leather, fabric or hand woven, ecru or grey, paper cord.

La forma è riportata a un sistema di ritmi di linee, con un segno morbido e continuo. Le gambe sono sottili e divaricate, per acquistare stabilità. Quelle anteriori si piegano a formare i braccioli e proseguono nella curva dello schienale. Le posteriori raggiungono lo schienale da dietro, per puntellarlo. Il sedile si inserisce tra le linee e le raccorda. Tobia Scarpa ha ridisegnato il giunto dei braccioli, per renderla più lineare e confortevole. Struttura in frassino naturale o tinto nero, seduta in pelle, tessuto o in corda intrecciata nei colori ecru e grigio.

**HERITA-**  
**GE COL-**  
**LECTION**



MHC.3 MISS —

CHAIRS—  
STAINED BLACK  
AND NATURAL ASH,  
HANDWOVEN PAPER CORD  
GREY AND ECRU COLOURS,  
L200, L209 LEATHERS

SEDIE—  
FRASSINO  
TINTO NERO E NATURALE,  
CORDA  
COLORI GRIGIO E ECRÙ,  
PELLI L200, L209





MHC.3 MISS —

CHAIR—  
STAINED BLACK ASH,  
HANDWOVEN PAPER CORD  
GREY COLOUR  
HEM CARPET—

CHAIR—  
STAINED BLACK ASH,  
L209 LEATHER

SEDIA—  
FRASSINO TINTO NERO,  
CORDA  
COLOR GRIGIO  
TAPPETO HEM—

SEDIA—  
FRASSINO TINTO NERO,  
PELLE L209





# D.235.1 MONTECATINI

GIO PONTI

Chair designed originally in 1938 for the first Palazzo Montecatini in Milan. This re edition is produced based on the original drawings from the Gio Ponti Archives. Entirely built from polished aluminium.

Sedia disegnata originariamente nel 1938 per il primo Palazzo Montecatini di Milano. La riedizione è prodotta sulla base dei disegni originali custoditi nei Gio Ponti Archives. Realizzata completamente in alluminio lucidato.

**HERITA-  
GE COL-  
LECTION**



D.235.1 MONTECATINI —

CHAIR—  
POLISHED ALUMINIUM  
LESSLESS TABLE—  
CHALK WHITE MATT LACQUER

SEDIA —  
ALLUMINIO LUCIDATO  
TAVOLO LESSLESS—  
LACCATO OPACO BIANCO CALCE



# OUTLINE

ARIK LEVY

Outline is the ideal companion for all tables due to the multitude of available versions: in full fabric or leather, or fabric and leather with metal legs. In 2025, it is enhanced with an additional padding to improve seating comfort. Outline combines comfort and functionality, thanks to an ergonomically correct fibreglass seat with removable fabric or leather covers.

Outline è la compagna ideale di tutti i tavoli grazie alla molteplicità delle versioni disponibili: totalmente in tessuto o pelle, in tessuto e pelle con gambe in metallo. Nel 2025 si arricchisce di una ulteriore cuscinatura per migliorare il comfort della seduta. Outline è caratterizzata dalla struttura in vetroresina appoggiata su gambe metalliche e dalla seduta ergonomica con rivestimenti sfoderabili in tessuto o pelle.



OUTLINE —

CHAIRS—  
WOODSTOCK WL221 FABRIC,  
IRIDIUM BROWN STRUCTURE  
FILIGREE TABLE—  
ARIAL BOISERIE—  
EONE CARPET—

SEDIE—  
TESSUTO WOODSTOCK WL221,  
STRUTTURA IRIDIUM BROWN  
TAVOLO FILIGREE—  
BOISERIE ARIAL—  
TAPPETO EONE—





OUTLINE —

CHAIR—  
SIRIA S1299 LEATHER,  
IRIDIUM BROWN STRUCTURE  
ROADS CARPET—

SEDIA—  
PELLE SIRIA S1299,  
STRUTTURA IRIDIUM BROWN  
TAPPETO ROADS—



OUTLINE —

CHAIRS—  
SIRIA S1299 LEATHER,  
IRIDIUM BROWN STRUCTURE  
FILIGREE TABLE—  
ARIAL BOISERIE—  
ROADS CARPET—

SEDIE—  
PELLE SIRIA S1299,  
STRUTTURA IRIDIUM BROWN  
TAVOLO FILIGREE—  
BOISERIE ARIAL—  
TAPPETO ROADS—





OUTLINE —

CHAIR—  
EXTRA L212 LEATHER

SEDIA—  
PELLE EXTRA L212

# DEVON

RODOLFO DORDONI

The Milanese designer Rodolfo Dordoni, also a master of trendy contemporary furnishings, has designed a collection of chairs suitable for any space and circumstance. Four chairs, two bucket armchairs, one bar stool with backrest and another without, these are the components of the Devon collection. All the frames are made of solid wood stained Eucalyptus, graphite Oak, black Oak, Sunrise Oak, coffee Oakveneers. Seats and backrests upholstered in fabric or leather chosen from the Molteni&C range. The strong feature of the solid wooden frame balances the fluid line of the backrests, blending ergonomics and elegance to create refined and comfortable chairs. Each element of the Devon collection expresses the value of craftsmanship, which is manifest in the way the top quality materials are processed, with details expressed with dedication and passion.

Rodolfo Dordoni, designer milanese, maestro dell'arredo contemporaneo di tendenza, disegna una collezione di sedute adatte ad ogni spazio e circostanza. Quattro sedie, due poltroncine a pozzetto, uno sgabello bar con supporto lombare e uno senza, sono gli elementi che compongono la collezione Devon. Tutte le strutture sono in massello tinto in essenza Eucalipto, Rovere grafite, Rovere nero, Rovere Sunrise, Rovere caffè. Sedute e schienali imbottiti in tessuto o pelle scelti tra la gamma Molteni&C. Il segno forte della struttura in massello bilancia la linea fluida degli schienali fondendo ergonomia ed eleganza per dare vita a sedute confortevoli e raffinate. Ogni singolo elemento della collezione Devon esprime il valore della maestria artigianale che trova evidenza nella lavorazione di materie prime di assoluta qualità con dettagli eseguiti con cura e passione.





DEVON —

CHAIRS—  
BLACK OAK BASE,  
EXTRA L162 LEATHER  
VIBRAZIONI CARPET—

SEDIE—  
BASAMENTO ROVERE NERO,  
PELLE EXTRA L162  
TAPPETO VIBRAZIONI—





DEVON —

CHAIR—  
WONDER WG447 COVER  
BLACK OAK BASE  
VIBRAZIONI CARPET—

SEDIA—  
RIVESTIMENTO WONDER WG447  
BASAMENTO ROVERE NERO  
TAPPETO VIBRAZIONI—



# CHELSEA

RODOLFO DORDONI

The value of handcraftsmanship is expressed in the masterful use of high quality raw materials: wood, fabric and leather. Details were designed and applied with passion and care, which underscores the versatile nature and appeal of these pieces. Available with completely removable cover, for both fabric and leather versions. Wood finishes: Eucalyptus, Sunrise Oak, coffee Oak, graphite Oak, black Oak; silica, moka and black glossy lacquered finishes.

Tutto il valore di una maestria artigianale si esprime nella lavorazione di materie prime di assoluta qualità, dal legno al tessuto alla pelle, con particolari fatti con cura e passione che garantiscono il fascino a queste sedute estremamente versatili. Prodotto completamente sfoderabile sia nelle versioni in tessuto che in pelle. Finiture essenza: Eucalipto, Rovere Sunrise, Rovere caffè, Rovere grafite, Rovere nero; laccato lucido silice, moka e nero.



CHELSEA —

CHAIRS—  
GRAPHITE OAK,  
KERMESSE KH733 FABRIC  
FILIGREE TABLE—  
BLACK NICKEL STRUCTURE,  
WHITE CARRARA MARBLE TOP  
HEM CARPET—

SEDIE—  
ROVERE GRAFITE,  
TESSUTO KERMESSE KH733  
TAVOLO FILIGREE—  
STRUTTURA NICKEL NERO,  
PIANO MARMO BIANCO CARRARA  
TAPPETO HEM—



CHELSEA —

CHAIRS—  
BLACK OAK,  
SAFIRE ZF613 FABRIC,  
SIRIA S1222 LEATHER

SEDIE—  
ROVERE NERO,  
TESSUTO SAFIRE ZF613,  
PELLE SIRIA S1222



# BARBICAN

RODOLFO DORDONI

A series of comfortable chairs suitable for all sorts of settings. The design is based on a built-in padded seat, open or complete with armrests, the stiff polyurethane frame of which can be fully upholstered in textiles or leather, or alternatively the two materials that highlight the wrap-around shape of the chair. The seat can have three types of bases made of different materials such as wood or metal in two versions, making Barbican perfect for use in diverse contexts. The wooden base with linked curves is perfect for important tables. The metal base, with its modern design, is perfect both round a table and with home office desks or console tables. The tubular version is light and airy, ideal for contract projects where ruggedness and practicality are prime considerations. Barbican is a versatile design that redefines the chair in a contemporary style.

Una serie di comode sedie adatte a tutte le tipologie di arredo. Il progetto è basato sulla seduta imbottita integrata, aperta o dotata di braccioli, la cui scocca, in poliuretano rigido, può essere rivestita in tessuto o pelle, totalmente o utilizzando alternativamente i due materiali che ne evidenziano la forma avvolgente. Alla seduta è possibile abbinare tre tipi di basamenti composti da materiali differenti come legno o metallo in due versioni, rendendo Barbican perfetta per l'utilizzo in contesti diversi. Il basamento di legno con curve raccordate è perfetto per accostarsi a tavoli importanti. Quello in metallo, moderno nel progetto, è perfetto sia attorno ad un tavolo che con scrivanie o consolle dedicate all'home office. Quello tubulare è leggero ed aereo, adattissimo a realizzazioni contract dove la robustezza e la praticità d'uso sono di primaria importanza. Barbican è un progetto poliedrico che ridefinisce la sedia in modo contemporaneo.





BARBICAN —

CHAIR—  
BASE ALUMINIUM DIE-CAST  
PEWTER COLOUR PAINT,  
BACKREST SHELL  
UNIQUE UE130 LEATHER,  
SEAT SHELL  
SAFIRE FABRIC  
PALETTE CARPET—

CHAIRS—  
EUCALYPTUS BASE,  
L216 LEATHER  
PALETTE CARPET—

SEDIA—  
BASAMENTO ALLUMINIO PRESSOFUSO  
VERNICIATO PELTRO,  
SCOCCA SCHIENALE  
PELLE UNIQUE UE130,  
SCOCCA SEDILE  
TESSUTO SAFIRE  
TAPPETO PALETTE—

SEDIE—  
BASAMENTO EUCALIPTO,  
PELLE L216  
TAPPETO PALETTE—



BARBICAN —

CHAIR—  
PEWTER COLOUR PAINT  
METAL BASE,  
UNIQUE UE195 LEATHER  
BACKREST SHELL,  
ZEUS ZI390 FABRIC  
SEAT SHELL

CHAIR WITH ARMS—  
PEWTER COLOUR PAINT  
METAL BASE,  
ZEUS ZI390 FABRIC  
BACKREST SHELL AND  
SEAT SHELL

SEDIA—  
BASAMENTO METALLICO  
VERNICIATO PELTRO,  
SCOCCA SCHIENALE  
PELLE UNIQUE UE195,  
SCOCCA SEDILE  
TESSUTO ZEUS ZI390

SEDIA CON BRACCIOLI—  
BASAMENTO METALLICO  
VERNICIATO PELTRO,  
SCOCCA SCHIENALE  
E SCOCCA SEDILE  
TESSUTO ZEUS ZI390





# PORTA VOLTA

HERZOG & DE MEURON

The Porta Volta Chair by Herzog & de Meuron marks a new chapter of collaboration between the historic brand Molteni&C and the renowned international architectural firm, long-term partners of the Molteni Group. The Porta Volta Chair highlights the relationship between the upholstered seat and the solid timber back, the defining element of the design. The floating backrest extends around the perimeter of the seat in a U-shape, extending forward to create the armrests, and resting on 3 intersecting wooden U-frames that feature a special curved bent "finger joint" detail at their rounded corners. The structure is crafted from high-quality solid woods. The thick padded seat, carefully rendered for the utmost comfort, is available in a wide range of fabrics, leather and in a special selection of Mohair velvet. The exclusive fabric collection is composed of 4 special custom-made colours: a bright sunflower yellow, a playful daisy pink, a deep royal blue and a silver grey. The chair has been imagined in two different sizes to allow for flexibility and a wider scope of use. The first is suited for dining - with a height of 71 cm, while the second, referred to as a low chair, is shorter at 66 cm and is intended for a living or a sitting room. One of the standout features of Porta Volta is the optional padding on the backrest, a rectangular-shaped element that latches onto the wooden beam, which is also available in a range of fabrics and leathers.

La sedia Porta Volta by Herzog & de Meuron segna un nuovo capitolo nella collaborazione tra lo storico brand Molteni&C e lo studio di architettura di fama internazionale, partner di lunga data del Gruppo Molteni. La sedia Porta Volta evidenzia il rapporto tra la seduta imbottita e lo schienale rigido, elemento principale del design. Lo schienale segue il perimetro della seduta a formare una U, spingendosi in avanti per creare i braccioli, mentre una giunzione a pettine, formata da tre elementi a forma di U intrecciati, lo collega al telaio sottostante e alle gambe. La struttura è realizzata con legno massello di alta qualità. La generosa imbottitura della seduta, appositamente studiata per regalare il massimo comfort, è disponibile in una vasta gamma di tessuti, pelli e una speciale selezione di velluto mohair. Sono 4 gli speciali colori su misura che vanno a comporre l'esclusiva collezione di tessuti: un vivace giallo girasole, un allegro rosa margherita, un intenso blu reale e un grigio argentato. La sedia è stata concepita in due diverse misure per una maggiore flessibilità e una più ampia destinazione d'uso. La prima versione, alta 71 cm, è adatta agli ambienti dining, mentre la seconda, ribattezzata "low chair", è pensata per il soggiorno o lo studio, essendo leggermente più bassa (66 cm). Su richiesta, la sedia Porta Volta può essere realizzata anche con lo schienale imbottito: alla fascia in legno si applica un apposito elemento rettangolare, disponibile anch'esso in una serie di tessuti e pelli.



PORTA VOLTA —

CHAIR—  
BLACK OAK STRUCTURE,  
SUNFLOWER YELLOW  
MOHAIR VELVET  
OLD FORD TABLE—  
EDGE CARPET—

SEDIA—  
STRUTTURA ROVERE NERO,  
VELLUTO MOHAIR  
SUNFLOWER YELLOW  
TAVOLO OLD FORD—  
TAPPETO EDGE—





PORTA VOLTA —

LOW CHAIRS—  
SUNRISE OAK STRUCTURE,  
WEB W6243 FABRIC

SEDIE LOW—  
STRUTTURA ROVERE SUNRISE,  
TESSUTO WEB W6243



PORTA VOLTA —

CHAIRS—  
BLACK OAK STRUCTURE  
ZAARA Z1724 FABRIC  
DIAMOND TABLE—  
PEWTER STRUCTURE,  
GREEN ALPINE MARBLE TOP  
STRIPE CARPET—

SEDIE—  
STRUTTURA ROVERE NERO  
TESSUTO ZAARA Z1724  
TAVOLO DIAMOND—  
STRUTTURA PELTRO,  
PIANO MARMO VERDE ALPI  
TAPPETO STRIPE—



# JANET

VINCENT VAN DUYSSEN

Featuring clean and delicate lines, Janet is the latest design by creative director Vincent Van Duysen to join Molteni&C's rich collection of chairs. Janet is a chair with or without arms featuring a solid wood stained frame Eucalyptus, black Oak, Sunrise Oak and coffee Oak. Smart and sturdy, it gives a certain presence around a host of different tables. Its constituent parts are carefully and precisely rounded to create a harmonious whole. The frame, printed and made ergonomic by a thin layer of superior polyurethane, is hooked onto the two structure's crossbars, top and bottom. The result is an exceptionally comfortable integrated system of chair and back that develops seamlessly. Janet comes with textile or leather upholstery from the Molteni&C range.

Dalle linee pulite e delicate, Janet è il nuovo progetto del direttore creativo Vincent Van Duysen che si inserisce nella ricca proposta di sedute Molteni&C. Janet è una sedia con e senza bracciolo, la cui struttura in legno massello tinto Eucalipto, Rovere nero, Rovere Sunrise e Rovere caffè è solida e conferisce presenza a un oggetto che può accompagnarsi a una moltitudine di tavoli diversi. Gli elementi che costituiscono la struttura sono arrotondati grazie a una lavorazione del legno attenta e precisa che crea un tutt'uno armonico. La scocca, stampata e resa ergonomica da un sottile strato di poliuretano superiore, si aggancia alle due traverse, inferiore e superiore, della struttura. Il risultato è un sistema integrato di seduta e schienale che si sviluppa senza soluzione di continuità e dal comfort eccezionale. Janet è proposta con rivestimenti in tessuto o pelle nella gamma Molteni&C.





JANET —

CHAIRS—  
EUCALYPTUS STRUCTURE  
KIWI KH520 FABRIC

SEDIE—  
STRUTTURA EUCALIPTO  
TESSUTO KIWI KH520



# GLOVE

PATRICIA URQUIOLA

A whole range of unconventional seating solutions: Sedute anticonvenzionali, pensate come aeree  
flexible aerial surfaces at the service of comfort. superfici elastiche al servizio del comfort. Una  
Glove, a technological structure coupled with struttura tecnologica accoppiata a strategiche  
strategic padding, won the Chicago Athenaeum imbottiture, Glove ha vinto The Chicago Athenaeum  
Good Design Award in 2007. Leather or fabric: Good Design Award 2007. Disponibile in pelle o  
fluid shake and continuous profiles where the tessuto, è caratterizzata da forme fluide e profili  
detail of a curve creates a silhouette without any continui, dove il dettaglio di una curva genera il  
additions or accessories. disegno senza aggiunte o accessori.



GLOVE —

CHAIRS—  
WILUNA WF530 FABRIC  
DIAMOND TABLE—  
BLACK MATT LACQUER STRUCTURE,  
SAHARA NOIR MARBLE TOP

SEDIE—  
TESSUTO WILUNA WF530  
TAVOLO DIAMOND—  
STRUTTURA LACCATO OPACO NERO,  
PIANO MARMO SAHARA NOIR





# GLOVE-UP

PATRICIA URQUIOLA

Glove-Up is the evolution of a rigorous design theme, featuring sinuous, moulded and softly linked lines. A balance of forms which, from the fluid line of the backrest, flows into the lightness of the legs. An inviting chair or small armchair, upholstered in fabric or leather, make Glove-Up fun and versatile, suitable for any classic or contemporary setting.

Glove-Up rappresenta l'evoluzione di un tema progettuale rigoroso, caratterizzato da linee sinuose, plasmate e morbidamente raccordate. Un equilibrio di forme che, dalla linea fluida dello schienale, confluisce nella leggerezza delle gambe. Sedia o poltroncina dal comfort accattivante, rivestite in tessuto o pelle, rendono Glove-Up spiritosa e versatile, adatta ad ogni ambiente classico o contemporaneo.



GLOVE UP —

CHAIRS—  
WOODSTOCK WL278 FABRIC  
DIAMOND TABLE—

SEDIE—  
TESSUTO WOODSTOCK WL278  
TAVOLO DIAMOND—



# WOODY

FRANCESCO MEDA

This solid wooden chair features harmoniously linked lines onto which the seat and backrest, both also made of wood or covered with bonded hide leather, are placed. The totally and seamlessly jointed, screw-free construction produces a lightweight, organic effect. Manual glueing with high tenacity glue. Plastic floor pads with kit of glides for different flooring types. The upholstery of the bonded hide leather version is not removable. The careful ergonomic study makes Woody comfortable, respecting the correct posture of the body.

Una solida struttura in legno massello caratterizzata da linee armoniosamente raccordate su cui sono posizionati sedile e schienale anch'essi di legno oppure rivestiti in cuoio rigenerato. La soluzione costruttiva senza alcuna vite realizzata interamente ad incastri produce un'immagine unitaria e leggera. Incollaggio manuale con collanti ad alta tenacità. Appoggi a terra in materiale plastico con puntali in kit per le diverse pavimentazioni. Nella versione in cuoio rigenerato il prodotto non è sfoderabile. L'attento studio ergonomico rende Woody confortevole, rispettando la corretta postura del corpo.



WOODY —

CHAIR—  
BLACK OAK STAINED ASH,  
SEAT AND BACKREST  
BLACK BONDED HIDE LEATHER

CHAIR—  
BLACK OAK STAINED ASH

SEDIA—  
FRASSINO TINTO ROVERE NERO,  
SEDILE E SCHIENALE  
CUOIO RIGENERATO NERO

SEDIA—  
FRASSINO TINTO ROVERE NERO



# 1 2 3

MICHAEL ANASTASSIADES

Its name whimsically reflects the process of finding the ideal balance in the number of vertical slats adorning the backrest. After thoughtful consideration and testing, three slats were chosen, resulting in a structure that exudes elegance and lightness, embodying a refined synthesis of design principles. "I've always been drawn to chairs with open backs," explains Michael Anastassiades, shedding light on the inspiration behind his creation. The absence of material in such chairs imbues them with visual lightness and a distinctive, iconic identity. This guiding concept led the designer on a journey of exploration, culminating in the selection of three precisely arranged vertical slats within a solid beech frame. Crafted and lacquered with care, the chair showcases seamless joinery techniques, enhancing its minimalist aesthetic. The 1 2 3 chair emerges as a versatile addition, enriching any setting with its distinctive presence, characterized by geometric purity and graceful lightness.

Un nome giocoso che sintetizza perfettamente l'esercizio di addizione nel trovare un numero minimo ed ottimale di listelli verticali nello schienale. Uno era troppo poco e due ancora troppo preziosi, la scelta finale opta per tre, giungendo alla sua struttura elegantemente rigorosa e leggera, che riflette una ponderata sintesi di concetti. "Ho sempre trovato più attraenti le sedie con lo schienale vuoto." Michael Anastassiades esprime l'ispirazione alla base di questo design, l'assenza di materiale nelle sedie con schienali vuoti conferisce loro una leggerezza visiva, un'identità iconica distintiva e attraente. Questo concetto ha guidato il processo creativo del designer attraverso una ricerca di forma e intuizione fino alla scelta definitiva di tre listelli verticali, disposti con precisione netta all'interno di una struttura in massello di faggio. Il legno magistralmente raccordato dalle mani artigianali e impeccabilmente laccato senza giunture visibili, infonde un pregio unico della tecnica della lacca, squisitamente in bilanciamento con il minimalismo della forma. La sedia 1 2 3 si configura così come un elemento trasversale, capace di arricchire qualsiasi spazio con la sua presenza distintiva caratterizzata dalla pulizia geometrica ed elegante leggerezza.

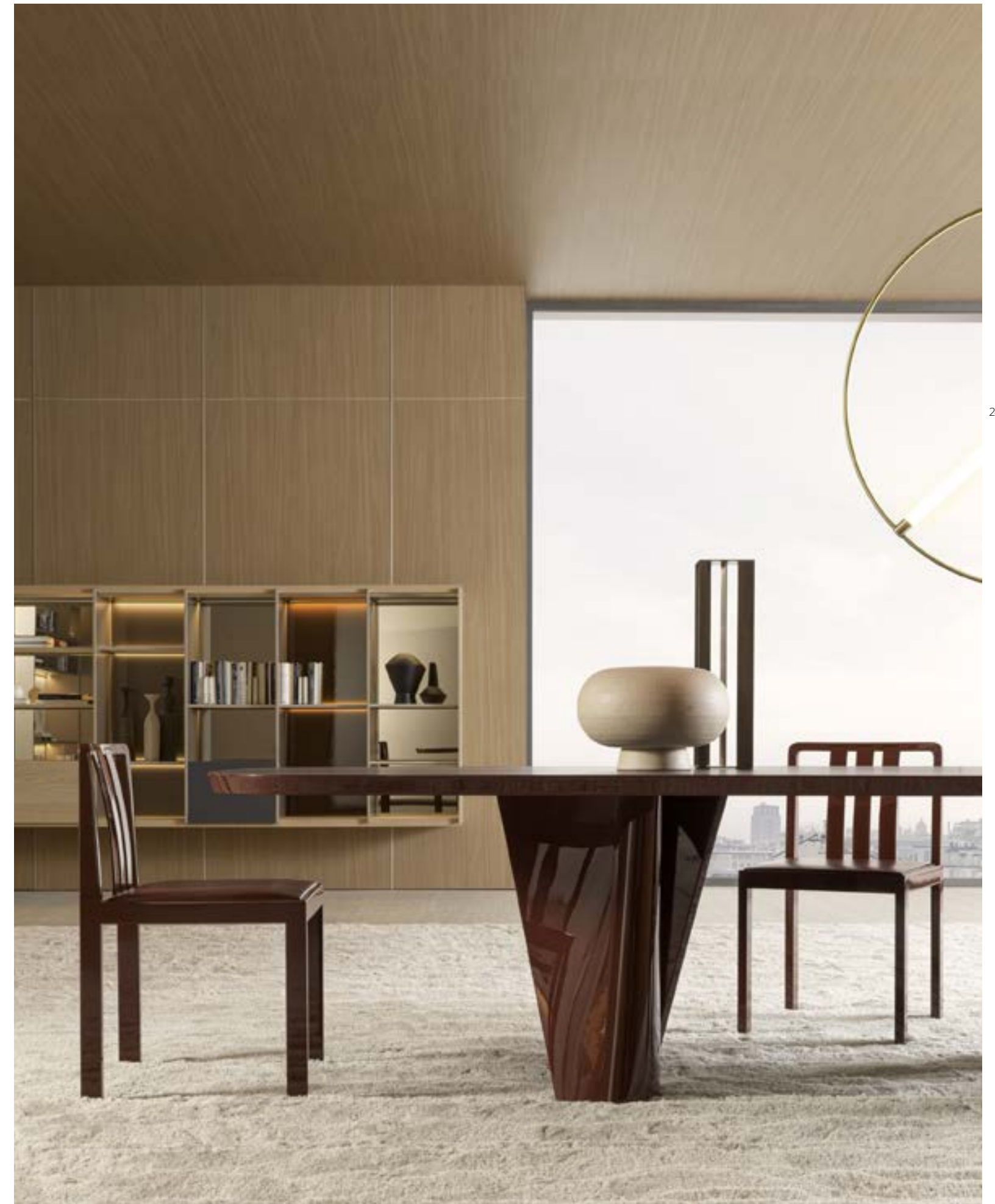

CHAIRS—  
GLOSSY BURGUNDY  
STRUCTURE WITH  
L211 EXTRA LEATHER SEAT,  
GLOSSY BLACK STRUCTURE  
WITH L200 EXTRA LEATHER SEAT,  
ARC TABLE—  
BLACK BASE,  
EXTRALIGHT GLASS TOP  
EONE CARPET—

SEDIE—  
STRUTTURA  
ROSSO BORGOGNA LUCIDO  
CON SEDUTA PELLE EXTRA L211,  
STRUTTURA NERO LUCIDO  
CON SEDUTA PELLE EXTRA L200  
TAVOLO ARC—  
BASAMENTO NERO,  
PIANO VETRO EXTRACHIARO  
TAPPETO EONE—





1 2 3 —

CHAIRS—  
GLOSSY BLACK STRUCTURE  
WITH L200 EXTRA LEATHER SEAT  
ARC TABLE—  
EONE CARPET—

CHAIR—  
GLOSSY PETROLEUM BLE STRUCTURE  
WITH UL188 UTOPIA LEATHER SEAT

SEDIE—  
STRUTTURA NERO LUCIDO  
CON SEDUTA PELLE EXTRA L200  
TAVOLO ARC—  
TAPPETO EONE—

SEDIA—  
STRUTTURA PETROLIO LUCIDO  
CON SEDUTA PELLE UTOPIA UL188



# TEA

JASPER MORRISON

The Tea chair is a tribute to lightness. The structure, completely made of solid wood, outlines and reveals the profile of the chair in its entirety. With Tea, the London designer redefines the concept of seating in a contemporary way, adapting it to all types of furniture, with stability and practicality being of primary importance. Its lines blend elegance and ergonomics in complete harmony to create comfortable yet sophisticated seating. The seat and backrest are available in the entire Molteni&C textile and leather collection.

La sedia Tea è un omaggio alla leggerezza. La struttura, completamente in massello, delinea e lascia percepire il profilo della sedia nella sua totalità. Con Tea, il designer londinese ridefinisce il concetto di seduta in modo contemporaneo, adattandola a tutte le tipologie di arredo, dove la robustezza e la praticità d'uso sono di primaria importanza. Le linee di Tea si fondono in completa armonia fra eleganza ed ergonomia, al fine di ricreare delle sedute confortevoli e allo stesso tempo sofisticate. Il sedile e lo schienale si declinano in tutta la Collezione tessile e pelle di Molteni&C.







TEA —

CHAIRS—  
BLACK OAK BASE,  
UEI21 LEATHER  
HALF A SQUARE TABLE—

SEDIE—  
BASE ROVERE NERO,  
PELLE UEI21  
TAVOLO HALF A SQUARE—



FURNITURE IS ROOTED IN THE GREAT, POSITIVE, ARTISAN TRADITION AND YET, CONTINUITY, HISTORICAL REFERENCES AND MEMORY SIT UNEASILY WITH AN OPEN, INCLUSIVE, EXPERIMENTAL APPROACH THAT TRIES TO INCORPORATE NEW TECHNOLOGIES AND NEW SOLUTIONS. PROFILES BEVELS, JOINS, DIFFERENT MATERIALS ALL MAKE UP THE INHERENT POETRY OF PERFECTION AND DETAIL. MUCH OF THE BEAUTY OF FURNITURE LIE PRECISELY IN THIS PERFECTION.

I MOBILI HANNO RADICI IN UNA GRANDE E POSITIVA TRADIZIONE ARTIGIANALE: E TUTTAVIA, CONTINUITÀ, RIFERIMENTO E MEMORIA CONVIVONO IN DIFFICILE EQUILIBRIO CON UN ATTEGGIAMENTO SPERIMENTALE E APERTO, INCLUSIVO, CHE PROVA AD INCORPORARE NUOVE TECNOLOGIE E NUOVE SOLUZIONI. SAGOME, SMUSSI, ATTACCHI, PASSAGGI DI MATERIE, COSTITUISCONO DALL'INTERNO UNA POETICA DELLA PERFEZIONE E DEL DETTAGLIO. IN QUESTA PERFEZIONE STA MOLTA DELLA BELLEZZA DEI MOBILI.

## single units and bookcases

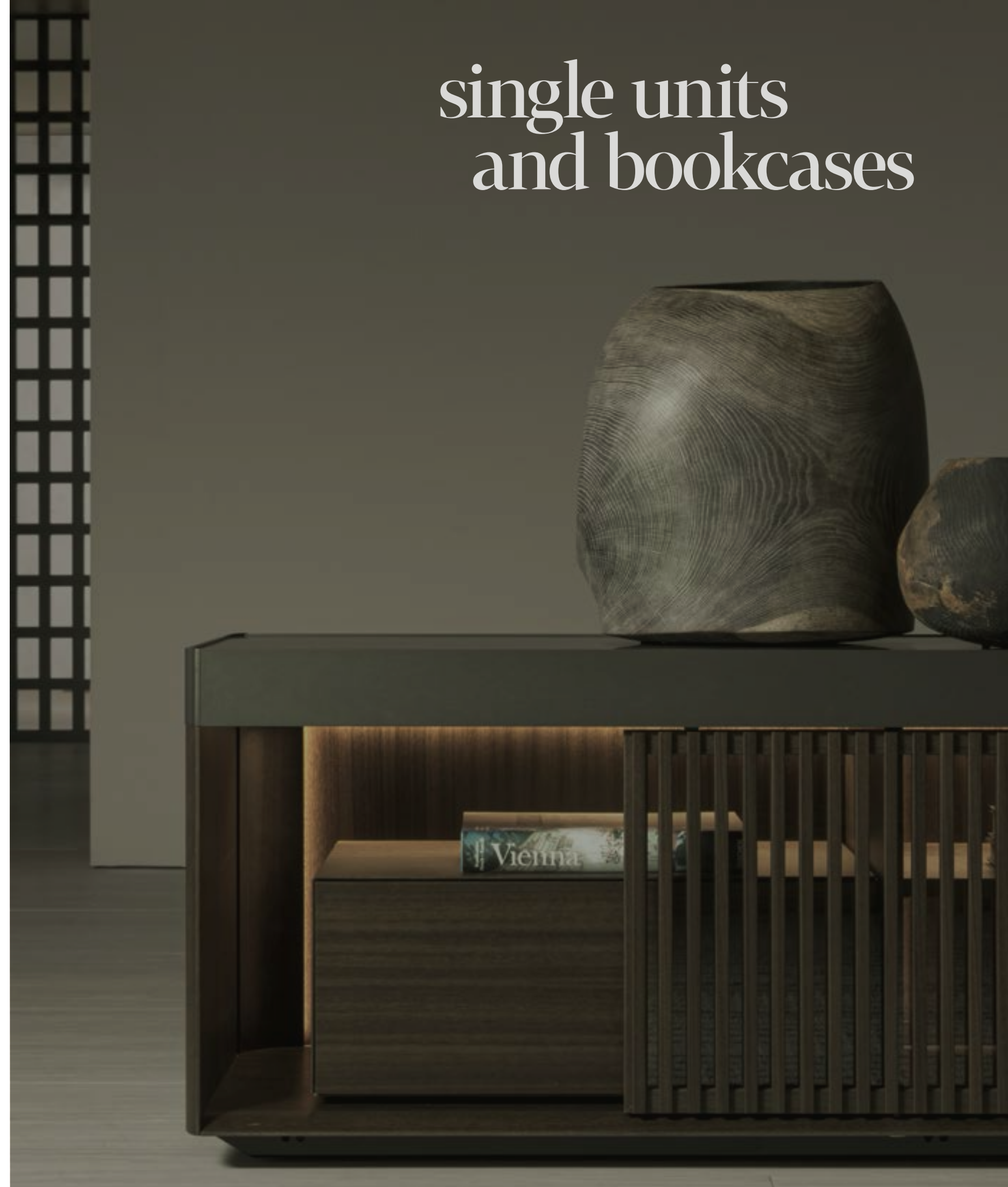

## D.655.1 D.655.2

GIO PONTI

Chest of drawers designed in several versions in the period from 1952 to 1955. This re edition is produced based on the original drawings from the Gio Ponti Archives. Marked by hand-painted white drawer fronts with applied handles in various wood kinds (elm, italian walnut, mahogany and rosewood). The elmwood frame rests on satin brass feet.

Comò disegnato in diverse varianti tra il 1952 e il 1955. La riedizione è prodotta sulla base dei disegni originali custoditi nei Gio Ponti Archives. È caratterizzato dai frontali dei cassetti verniciati a mano in colore bianco con maniglie applicate di varie essenze (olmo, noce nazionale, mogano e palissandro). La struttura in essenza di olmo è sostenuta da piedi in ottone satinato.

**HERITA-  
GE COL-  
LECTION**



CHEST OF DRAWERS—  
ELM, ITALIAN WALNUT,  
MAHOGANY, ROSEWOOD,  
WHITE HAND-PAINTED,  
SATIN BRASS  
D.153.1 ARMCHAIR—

D.655.1 —

CASSETTONE—  
OLMO, NOCE NAZIONALE,  
MOGANO, PALISSANDRO,  
VERNICIATO A MANO BIANCO,  
OTTONE SATINATO  
POLTRONA D.153.1—

# MHC.1

WERNER BLASER

MHC.1 is a new edition of the prototype of the first modern piece of furniture made by Molteni&C, the chest of drawers designed by Werner Blaser. Thought it was never produced industrially, in 1955 it won first prize at the Cantù "Prima Mostra Selettiva - Concorso internazionale del mobile", a competition designed to re-qualify the image of Italian furniture making. The jury was made up of Gio Ponti, Alvar Alto, Romano Barocchi, Carlo de Carli and Finn Juhl. The unusual joinery features a simple three-fork joint. After issuing a limited edition run of 100 numbered pieces, two new non-numbered versions are available in the new black stained and honey stained ash finishes.

MHC.1 è una riedizione del prototipo del primo mobile moderno realizzato da Molteni&C, il cassettone disegnato da Werner Blaser. Mai entrato in produzione, vince il primo premio al concorso internazionale di Cantù del 1955, Prima Mostra Selettiva, indetto per riqualificare l'immagine produttiva italiana. La giuria è composta da Gio Ponti, Alvar Alto, Romano Barocchi, Carlo de Carli e Finn Juhl. Particolare il sistema costruttivo basato sulla giunzione semplice a triplice forcella. Dopo una prima riedizione limitata di 100 pezzi numerati, è ora disponibile in due nuove versioni non numerate nelle inedite finiture frassino tinto nero e tinto miele.

## HERITAGE COLLECTION



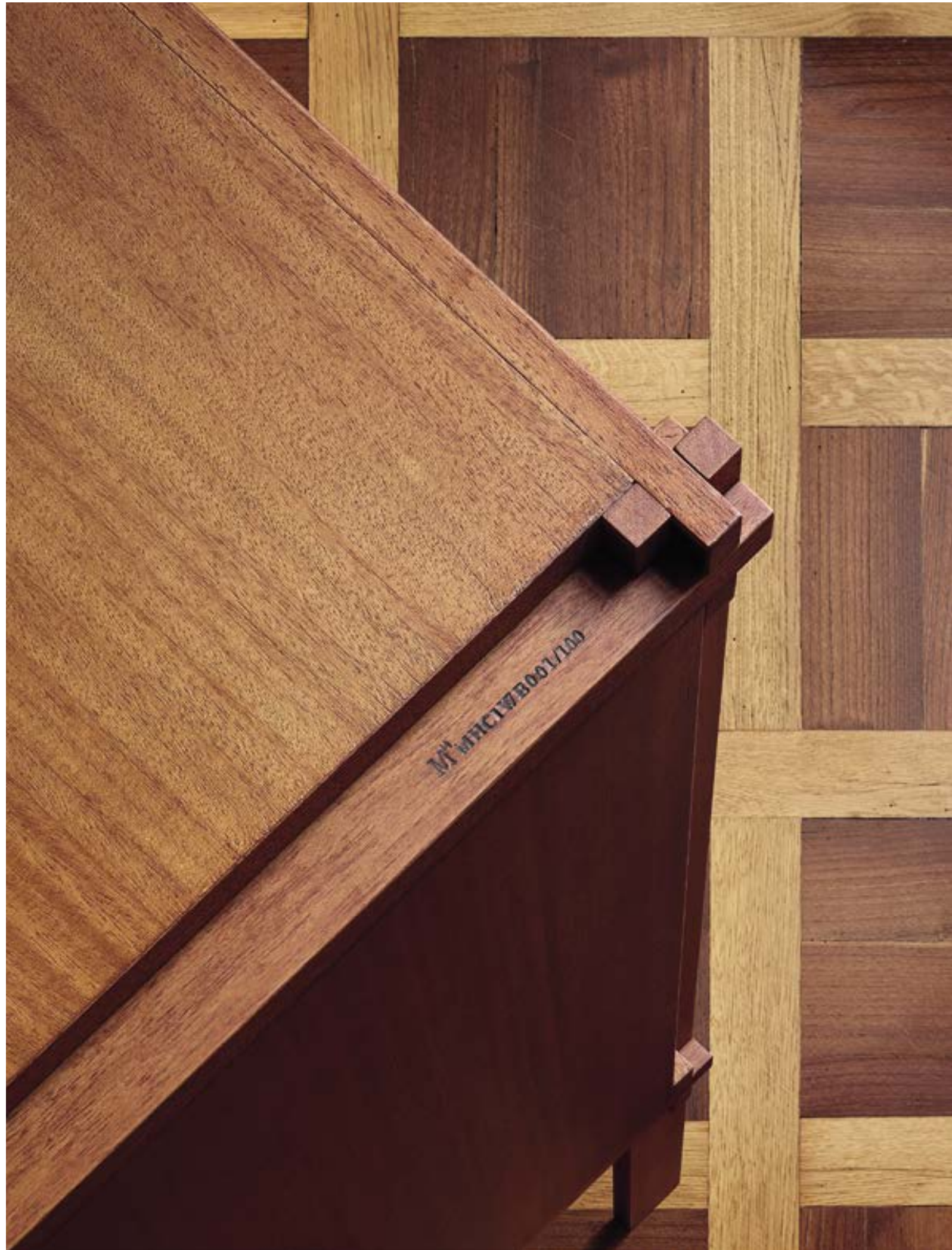

MHC.1 —

CHEST OF DRAWERS—  
HONEY STAINED ASH

CASSETTIERA—  
FRASSINO TINTO MIELE



# ANDROMEDA

STUDIO LSM

The Andromeda sideboard, created through a collaboration between UniFor and LSM, enriches the Molteni&C collection starting in 2025. The sideboard is characterized by four compartments, with two hinged doors at the center, and a side shelf that enriches the surrounding space. The entire product develops from a shiny steel "cusp" section with tapered edges. The base, a distinctive element, is positioned along the two internal sides, allowing the sideboard to "float" on the two lateral wings. The glass top finally enhances and harmonizes the overall design, completing the result with elegance and refinement.

La madia Andromeda nasce da un progetto di UniFor e LSM e arricchisce a partire dal 2025 anche la collezione Molteni&C. La madia è caratterizzata da quattro vani, con due ante battenti al centro, e un ripiano laterale che arricchisce lo spazio circostante. L'intero prodotto si sviluppa su una sezione di acciaio lucido "a cuspide" con i bordi rastremati. Il basamento, un elemento distintivo, è posizionato lungo le due spalle interne, permettendo alla madia di "volare" sospesa sulle due ali laterali. Il top in vetro, infine, arricchisce e armonizza l'intero design, completando il risultato con eleganza e raffinatezza.





ANDROMEDA —

CUPBOARD—  
GLASS SHELVES,  
SHINY STEEL STRUCTURE,  
TOP AND DOORS  
ARIAL BOISERIE—

MADIA—  
RIPIANI IN VETRO,  
STRUTTURA, TOP E ANTE  
ACCIAIO LUCIDO  
BOISERIE ARIAL—





ANDROMEDA —

CUPBOARD—  
GLASS SHELVES,  
SHINY STEEL STRUCTURE,  
TOP AND DOORS  
ODILE, LEA COFFEE TABLES—  
ORIZZONTI CARPET—

MADIA—  
RIPIANI IN VETRO,  
STRUTTURA, TOP E ANTE  
ACCIAIO LUCIDO  
TAVOLINI ODILE, LÉA—  
TAPPETO ORIZZONTI—



# LIVING BOX

VINCENT VAN DUYSSEN

Living Box was conceived as an independent item of furniture, usable in any room of the house, but mainly suitable for the living room. Despite its reduced size, it retains the rigour and monumentality of the building it derives from, accentuating its details by means of quality materials. Living Box is a low, but large (230, 280, 330, 380) rectangular container, in which the outside and inside contrast with each other via the use of different materials. The interior space is divided and enclosed by sliding "Stripe" doors, already used in Molteni&C Kitchens, made with a wood frame and central glass. The doors are placed in the heart of the compositions, creating private spaces, while the precious boxes remain at both ends. The top features marble and different woods, specially arranged to decorate the surface. The whole is enclosed within an iris and pewter frame, thread-like if seen from above, but forming a thick profile surrounding the inside space if seen from the front. The top can be fitted and integrated with trunking, useful for facilitating connections of any kind between multimedia equipment, TVs or lighting equipment. Suffused lighting is provided by Leds. The inside space is completely free and devoid of sharp corners thanks to special curved corner-covers. The space created in this way allows any type of object to be displayed at will. If this scenographic solution does not fit the purpose, one or more sober and elegant sets of drawers can be added, with an iris and pewter, or a wood finish and featuring a sober and elegant design. These occupy the free space, concealing what is useful but preferably not visible.

Living Box è un contenitore rettangolare, basso, di grandi dimensioni (230, 280, 330, 380), in cui esterno ed interno si contrappongono attraverso l'utilizzo di materiali diversi. Lo spazio interno viene suddiviso e delimitato dalle ante scorrevoli modello "Stripe", già utilizzate nelle cucine Molteni&C, realizzate con un telaio in essenza e un vetro centrale. Le ante si collocano nel cuore delle composizioni, creando spazi privati, mentre ai due estremi si trovano i preziosi box. L'esterno è caratterizzato da una grande superficie d'appoggio, dove marmi ed essenze sono utilizzate per decorarne il piano tramite particolari disposizioni geometriche dei materiali impiegati. Il tutto è racchiuso in una cornice, in iris e peltro, all'apparenza filiforme se vista dall'alto, ma che vista di fronte si trasforma in un vero e proprio profilo a forte spessore che contorna il vano interno. Il piano può essere predisposto e integrato con passacavi, utili a facilitare i collegamenti di qualsiasi genere tra apparecchiature multimediali, TV o apparecchi di illuminazione. La luce a Led lo illumina in modo soffuso. Lo spazio interno è completamente libero e privo di angoli acuti grazie a speciali copri-angoli curvi. Lo spazio così creato è disponibile ad accogliere qualsiasi tipo di oggetto che si voglia appoggiare e mostrare. Se questa soluzione scenografica risultasse all'apparenza non funzionale è possibile aggiungere una o più cassettiere, con finitura iris e peltro o in essenza, dal disegno sobrio ed elegante che vanno a popolare lo spazio libero nascondendo ciò che è utile ma si preferisce non rivelare.



CUPBOARD—  
SUNRISE OAK STRUCTURE,  
PARTITIONS AND TOP.  
EXTRA-CLEAR TRANSPARENT  
GLASS AND SUNRISE OAK  
STRIPE DOORS,  
IRIS FRAME TOP AND DRAWERS,  
LED LIGHTING  
ROADS CARPET—  
LOUISA COFFEE TABLES—  
ARIAL BOISERIE—  
ROADS CARPET—

MADIA—  
STRUTTURA, DIVISORI  
E TOP ROVERE SUNRISE,  
ANTE STRIPE VETRO  
EXTRACHIARO TRASPARENTE  
E ROVERE SUNRISE,  
CORNICE TOP E CASSETTI IRIS,  
ILLUMINAZIONE LED  
TAVOLINI LOUISA—  
BOISERIE ARIAL—  
TAPPETO ROADS—



LIVING BOX —

CUPBOARD—  
EUCALYPTUS STRUCTURE,  
PARTITIONS AND DRAWERS,  
SAHARA NOIR MARBLE TOP,  
EXTRA-CLEAR GLASS AND  
EUCALYPTUS STRIPE DOORS,  
PEWTER TOP FRAME,  
LED LIGHTING

MADIA—  
STRUTTURA, DIVISORI E  
CASSETTI EUCALIPTO,  
TOP MARMO SAHARA NOIR,  
ANTE STRIPE VETRO  
TRASPARENTE ED EUCALIPTO,  
CORNICE TOP PELTRO,  
ILLUMINAZIONE LED

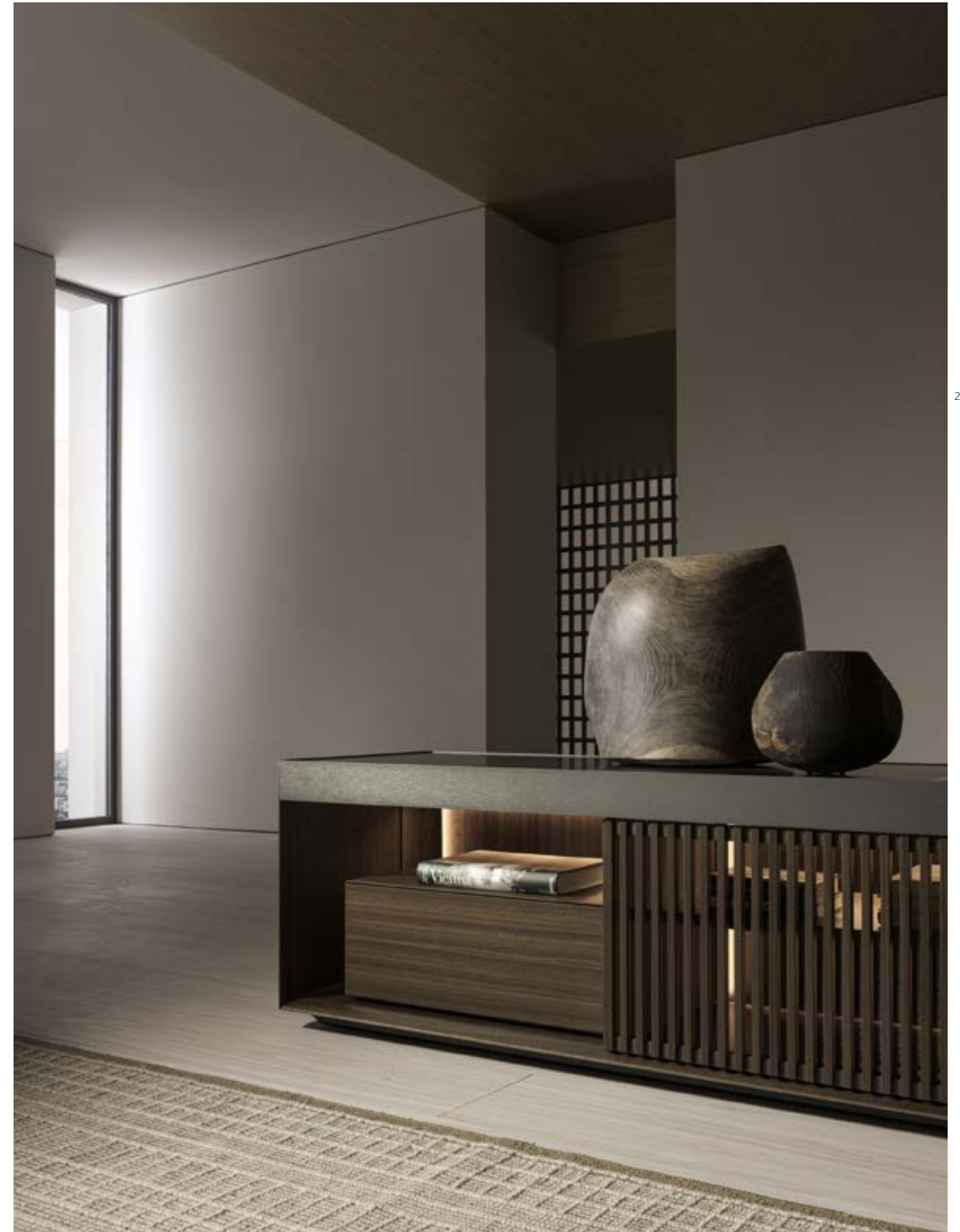

LIVING BOX —

CUPBOARD—  
EUCALYPTUS STRUCTURE,  
PARTITIONS AND DRAWERS,  
SAHARA NOIR MARBLE TOP,  
EXTRA-CLEAR GLASS AND  
EUCALYPTUS STRIPE DOORS,  
PEWTER TOP FRAME,  
LED LIGHTING  
MONK CHAIR—  
ORIZZONTI CARPET—

MADIA—  
STRUTTURA, DIVISORI E  
CASSETTI EUCALIPTO,  
TOP MARMO SAHARA NOIR,  
ANTE STRIPE VETRO  
TRASPARENTE ED EUCALIPTO,  
CORNICE TOP PELTRO,  
ILLUMINAZIONE LED  
SEDIA MONK—  
TAPPETO ORIZZONTI—





LIVING BOX —

CUPBOARD—  
SUNRISE OAK STRUCTURE—  
BRECCIA CAPRAIA MARBLE  
TOP IRIS TOP FRAME  
DRAWERS—  
IRIS

MADIA—  
STRUTTURA ROVERE SUNRISE—  
TOP MARMO BRECCIA CAPRAIA  
CORNICE TOP IRIS  
CASSETTI—  
IRIS



LIVING BOX —

CUPBOARD—  
SUNRISE OAK STRUCTURE AND TOP—  
PEWTER COLOUR TOP  
FRAME DRAWERS—  
PEWTER COLOUR

MADIA—  
STRUTTURA E TOP ROVERE SUNRISE—  
CORNICE TOP PELTRO  
CASSETTI—  
PELTRO





## LIVING BOX —

CUPBOARD—  
SUNRISE OAK STRUCTURE AND TOP  
PEWTER COLOUR TOP  
FRAME DRAWERS—  
PEWTER COLOUR

MADIA—  
STRUTTURA E TOP ROVERE SUNRISE—  
CORNICE TOP PELTRO  
CASSETTI—  
PELTRO





LIVING BOX —

CUPBOARD—  
EUCALYPTUS STRUCTURE  
SAHARA NOIR TOP  
IRIS FRAME TOP DRAWERS—  
EUCALYPTUS IRIS PROFILE

MADIA—  
STRUTTURA EUCALIPTO  
TOP SAHARA NOIR CORNICE  
TOP IRIS CASSETTI—  
EUCALIPTO PROFILO IRIS





LIVING BOX —

CUPBOARD—  
EUCALYPTUS STRUCTURE—  
SAHARA NOIR TOP  
IRIS FRAME TOP DRAWERS—  
EUCALYPTUS IRIS PROFILE

MADIA—  
STRUTTURA EUALIPTO  
TOP SAHARA NOIR CORNICE  
TOP IRIS CASSETTI—  
EUALIPTO PROFILO IRIS



# HORIZONS

DANTE BONUCCELLI

With Horizons, a cupboard for the daytime area, Dante Bonuccelli proposes a different way of storing, and at the same time displaying muchloved objects. Two tip-up doors, which, when closed, reveal the contents thanks to both the transparent stopsol glass and the internal LED lighting, and when open, folded back against the side of the piece for full access to the internal space, transform the cupboard like a chameleon. Inside the exquisitely detailed graphite Oak or coffee Oak structure, the two suspended drawers and the top shelf, which re-divides the space, are enhanced with calacatta marble or Sahara noir. The pewter colour framed and transparent stopsol glass doors are available with or without the graphite Oak or coffee Oak cross pieces. The former feature asymmetrically placed horizontal profiles, reminiscent of a shed that only partially reveals the inside, increasing curiosity about its contents. Designed as a cupboard for the dining area, thanks also to useful accessories such as the cutlery holder and the Eco Skin drawer bottom, or as a vitrine for precious objects.

Dante Bonuccelli con Horizons, mobile contenitore per l'area giorno, propone un diverso modo di contenere e nel contempo mostrare oggetti di affezione. Due ante basculanti, che chiuse rivelano il contenuto grazie al vetro stopsol trasparente e alla illuminazione interna LED, o aperte, ripiegate e affiancate alla struttura laterale per un accesso totale allo spazio interno, danno vita ad un oggetto che si trasforma "camaleonticamente". All'interno della struttura in Rovere grafite o Rovere caffè, dettagli preziosi, i due cassetti sospesi e la mensola superiore che ridivide lo spazio, arricchiscono questo prodotto gli schienali in marmo calacatta o Sahara noir. Le ante nella sua cornice petro e vetro stopsol trasparente, sono disponibili con e senza traversini rivestiti in Rovere grafite o Rovere caffè. Le prime si connotano per i profili orizzontali posti asimmetricamente, quasi a dar vita ad uno "shed" che mostra solo parzialmente l'interno, aumentando la curiosità per il suo contenuto. Pensato come madia per la zona dining, grazie anche agli utili accessori come porta posate e il fondo dei cassetti in Eco Skin, oppure come contenitore vetrina per oggetti di pregio.



# TEOREMA

RON GILAD

A unit with open compartments or drawers used as a single unit or stacked in a linear or offset mode, to create night tables, chests of drawers or modular systems for the living area. Structure completely faceted like a diamond and made of a single piece veneered in American walnut, eucalyptus or coffee oak. The construction is a perfect fusion of precision mechanical working and artisanal skills in the folding and gluing of the piece.

Elemento singolo o composto sovrapponendo vari elementi per dare vita a comodini, cassettiere, composizioni per la zona living lineari o disassate. Struttura completamente sfaccettata a diamante ricavata da un unico pezzo rivestito in noce canaletto, eucalipto o rovere caffè. La realizzazione è il perfetto connubio tra la precisione centesimale della lavorazione meccanica e la sapienza artigianale nella piegatura e nell'incollaggio della struttura.





TEOREMA —

DRAWER UNIT—  
SPIRAL COMPOSITION  
AMERICAN WALNUT,  
SHINY CHROME HANDLE

CONTENITORE—  
COMPOSIZIONE A SPIRALE  
NOCE CANALETTO,  
MANIGLIA CROMO LUCIDO



# ADRIEN

VINCENT VAN DUYSSEN

Adrien expresses a desire to present a new series of storage units, conceptually avantgarde both in technological and in aesthetic terms. Adrien is a fortunate combination of purity of form and exclusive materials and technologies, blended harmoniously and with a focus on key visual and tactile aspects. In Adrien the structural aluminium thickness is reduced to a minimum, allowing the Stopsol glass and the built-in LED lighting system of the shelves to enhance the appeal of the objects displayed. The back panel can be made of wood or glass to highlight the complete transparency of the object.

Adrien nasce dalla volontà di presentare una nuova serie di madie concettualmente all'avanguardia sia tecnologicamente che sotto il profilo estetico. Adrien rappresenta una felice combinazione tra purezza delle forme, uso di materiali e tecnologie esclusive che si compongono armoniosamente dove l'aspetto visivo e tattile riveste grande importanza. In Adrien si riduce al minimo lo spessore strutturale in alluminio, lasciando che il Vetro Stopsol e il sistema di illuminazione a LED integrato nei ripiani, valorizzi al massimo gli oggetti esposti. Lo schienale può essere in essenza o vetro per dare la completa trasparenza all'oggetto.



ADRIEN —

CUPBOARD—  
EUCALYPTUS,  
PEWTER FINISH GLASS  
DOOR FRAME,  
TRANSPARENT STOPSOL GLASS,  
LED LIGHTING BARS  
RANDOM CARPET—

MADIA—  
EUCALIPTO,  
TELAIO ANTE VETRO  
PELTRO,  
VETRO STOPSOL TRASPARENTE,  
BARRE ILLUMINANTI A LED  
TAPPETO RANDOM—





ADRIEN —

CUPBOARD—  
EUCALYPTUS,  
EMPERADOR DARK MARBLE TOP,  
PEWTER FINISH GLASS  
DOOR FRAME,  
TRANSPARENT STOPSOL GLASS,  
LED LIGHTING BARS

MADIA—  
EUCALIPTO,  
TOP MARMO EMPERADOR DARK,  
TELAIO ANTE VETRO  
PELTRO,  
VETRO STOPSOL TRASPARENTE,  
BARRE ILLUMINANTI A LED





# CARTEGGIO

ALDO ROSSI

A wood writing desk with drawers and pull out top  
protected by a blind. To organize and rearrange  
our daytime.

Mobile secretaire a cassetti in essenza, con ripiano  
estraibile protetto da una tapparella scorrevole. Per  
organizzare e riordinare le nostre giornate.



## D.357.1 D.357.2

GIO PONTI

Designed in 1956-1957, the bookcase is part of the furniture of Gio Ponti's private house in via Dezza in Milan. This re edition is produced based on the original drawings from the Gio Ponti Archives. Made from shaped multi-layered material with elm veneer, partly with natural transparent finish, partly hand-painted in white. Available in the versions with or without applied mirror.

Disegnata tra il 1956 e il 1957, la libreria fa parte degli arredi dell'abitazione privata di Gio Ponti in via Dezza a Milano. La riedizione è prodotta sulla base dei disegni originali custoditi nei Gio Ponti Archives. Realizzata in multistrato sagomato con rivestimento in olmo, in parte con finitura trasparente naturale, in parte verniciato a mano in colore bianco. È disponibile nella versione con o senza specchiera applicata.

**HERITA-  
GE COL-  
LECTION**





D.357.1 —

BOOKCASE—  
ELM,  
WHITE HAND-PAINTED  
D.154.2 ARMCHAIR—  
PANNA COTTA COFFEE TABLE—

LIBRERIA—  
OLMO,  
VERNICIATO A MANO BIANCO  
POLTRONA D.154.2—  
TAVOLINO PANNA COTTA—



## D.355.1 D.355.2

GIO PONTI

An object that the great Milanese architect was to re-design several times over the years, re-fashioned in the version for his via Dezza house in Milan, elmwood, hand-painted white, 240 or 195 cm long, with two partitions.

Un oggetto che il grande architetto milanese ridisegna più volte nel corso degli anni, rieditato nella versione per la sua casa di via Dezza a Milano, finitura in olmo, verniciato bianco a mano, 240 o 195 cm di lunghezza, con due divisori.

**HERITA-**  
**GE COL-**  
**LECTION**



D.355.1 —

SUSPENDED BOOKCASES—  
ELM,  
WHITE HAND-PAINTED  
D.154.2 ARMCHAIRS—  
HEM CARPET—

LIBRERIE SOPPESE—  
OLMO,  
VERNICIATO A MANO BIANCO  
POLTRONE D.154.2—  
TAPPETO HEM—



## MHC.2

YASUHIKO ITOH

MHC.2 is a re-edition of the bookcase prototype designed in 1959 by Yasuhiko Itoh. Made in curved wood, a complex process for that time period, it won an award at the 3rd edition of the Selettiva competition in Cantù del 1959. This piece is both elegant and refined. After issuing a limited edition run of 100 numbered pieces, this item is now available as a standard, non-numbered piece in curved wood covered in walnut.

MHC.2 è una riedizione del prototipo della libreria disegnata nel 1959 da Yasuhiko Itoh. Realizzata in legno curvato, lavorazione complessa per l'epoca, fu premiata alla 3° edizione della Selettiva di Cantù del 1959. Il risultato è un pezzo elegante e raffinato. Dopo una prima riedizione limitata di 100 pezzi numerati, è ora disponibile in serie non numerata in legno curvato rivestito in noce.

HERITA-  
GE COL-  
LECTION



MHC.2 —

BOOKCASE—  
CURVED WOOD WITH  
AMERICAN  
WALNUT FINISH

LIBRERIA—  
LEGNO CURVATO  
RIVESTITO  
DI NOCE CANALETTO



# GRADUATE

JEAN NOUVEL

Jean Nouvel has designed a brilliant wall structure resolved in a single shelf anchored to the wall or to the ceiling. Slender steel braces support adjustable shelves in wood and aluminium that seem to float in the air thanks to invisible support mechanisms. Transparency and lightness in space made up of air.

Jean Nouvel ha disegnato una virtuosistica struttura sospesa, risolta da un'unica mensola ancorata a parete o a soffitto. Esili tiranti in acciaio reggono i ripiani regolabili in legno e alluminio, che paiono galleggiare nel vuoto grazie a invisibili meccanismi di sostegno. La leggerezza della trasparenza in un volume fatto di aria.





BOOKCASE—  
BLACK ALUMINIUM SHELVES  
STAINLESS STEEL TIE RODS  
DIAMOND TABLE—  
MONK CHAIRS—  
STRIPE CARPET—

LIBRERIA—  
RIPIANI IN ALLUMINIO NERO  
TIRANTI IN ACCIAIO INOX  
TAVOLO DIAMOND—  
SEDIE MONK—  
TAPPETO STRIPE—



GRADUATE —

BOOKCASE—  
BLACK ALUMINIUM SHELVES  
STAINLESS STEEL TIE RODS  
MARGOU ARMCHAIRS—  
MARTEEN SEATING SYSTEMS—

LIBRERIA—  
RIPIANI IN ALLUMINIO NERO  
TIRANTI IN ACCIAIO INOX  
POLTRONE MARGOU—  
SISTEMA DI SEDUTE MARTEEN—



# PIROSCAFO

ALDO ROSSI, LUCA MEDA

Aldo Rossi and Luca Meda have designed a piece of architecture; a large facade featuring regularly spaced windows and inspired by the Regione Umbria headquarter's facade in Perugia. A bookcase with glass front and Eucalyptus wood or lacquered structure and a metal front matt lacquered. Piroascafo is a versatile home cupboard - a bookcase for the study, a display cabinet for the living room or a sideboard for the kitchen. The new façade lacquered in a warm Spice colour with Eucalyptus interiors re-proposes a classic piece in a contemporary version without betraying its origins as a rigorous but functional piece of furniture. The dimensions reflect current production.

Aldo Rossi e Luca Meda disegnano una vera e propria architettura, una grande facciata scandita dal ritmo regolare delle finestre e ispirata alla facciata della sede della Regione Umbria a Perugia. Una libreria vetrata con struttura in Eucalipto o laccata e facciata metallica laccata in colori opachi. Piroascafo è un versatile e raffinato magazzino domestico: libreria nello studio, vetrina in soggiorno, madia in cucina. La nuova facciata laccata in un caldo colore Spice con interni in Eucalipto ripropone un classico in una versione contemporanea senza tradire le sue origini di arredo rigoroso ma funzionale. Le dimensioni rispecchiano la produzione corrente.



PIROSCAFO —

BOOKCASE—  
CHALK WHITE FRONT,  
EUCALYPTUS STRUCTURE  
OVAL TABLE ARC—  
GREY BASE,  
EXTRALIGHT GLASS TOP  
MONTECATINI D.235.1 CHAIRS—  
POLISHED ALUMINIUM

LIBRERIA—  
FACCIATA BIANCO CALCE,  
STRUTTURA EUCALIPTO  
TAVOLO OVALE ARC—  
BASAMENTO GRIGIO,  
PIANO VETRO EXTRACHIARO  
SEDIE MONTECATINI D.235.1—  
ALLUMINIO LUCIDATO



# CARD

MICHAEL ANASTASSIADES

Card marks a new chapter in the quest for furniture that embodies the needs of modern living while maintaining a high level of technological innovation. A testament to rigorous research and development, the Card bookcase focuses on intricate details, with each element crafted to perfection. Of fered in black oak, the freestanding structure houses authentic technological marvels, including satin brass finish joints that elegantly connect the horizontal planes to the vertical uprights. Material juxtaposition is a hallmark of Michael Anastassiades' design philosophy, evident in the Card bookcase through the inclusion of a Sahara noir marble shelf. Structurally, the bookcase offers four different compositional possibilities: high shelf, low shelf, console, bedside table.

La libreria Card rappresenta un nuovo capitolo nella ricerca di prodotti concepiti per interpretare le esigenze dell'abitare contemporaneo, mantenendo costantemente elevato il livello di sperimentazione tecnologica. L'impegno nella ricerca e sviluppo si concentra sui dettagli, elementi minutamente curati e sempre al centro dell'attenzione di Molteni&C. La struttura freestanding è proposta in rovere nero e racchiude al suo interno autentici gioielli tecnologici, come i giunti in finitura ottone satinato, distintivi e volutamente visibili, che collegano in modo ortogonale i piani orizzontali ai montanti verticali. L'accostamento dei materiali è un aspetto attraverso il quale Michael Anastassiades esprime la sua poesia, nella libreria Card opta infatti per l'inserimento di un ripiano in marmo Sahara noir, un tono su tono con il rovere nero contraddistinto dalla diversità dei materiali, creando un'interessante contrapposizione. Strutturalmente, si offrono in totale quattro possibilità compositive proposte a catalogo: libreria alta, libreria bassa, console e comodino.







CARD —

< p. 270-271  
BOOKCASE—  
BLACK OAK STRUCTURE,  
BRASS JOINTS,  
SAHARA NOIR MARBLE SHELF  
LESSLESS TABLE—  
BLACK MATT LACQUER  
PORTA VOLTA CHAIR—  
EUCALYPTUS STRUCTURE  
WEB W6233 FABRIC  
VIBRAZIONI CARPET—

p. 270-271  
LIBRERIA—  
STRUTTURA ROVERE NERO,  
GIUNTI OTTONE,  
MENSOLA MARMO SAHARA NOIR  
TAVOLO LESSLESS—  
LACCATO OPACO NERO  
SEDIA PORTA VOLTA—  
STRUTTURA EUCALIPTO  
TESSUTO WEB W6233  
TAPPETO VIBRAZIONI—



# D.950.1

GIO PONTI

Framed mirrors designed in 1950 in three several sizes. Cornici con specchio disegnate nel 1950 in tre diverse dimensioni. Sono realizzate in massello verniciato a mano in colore bianco.

**HERITA-  
GE COL-  
LECTION**

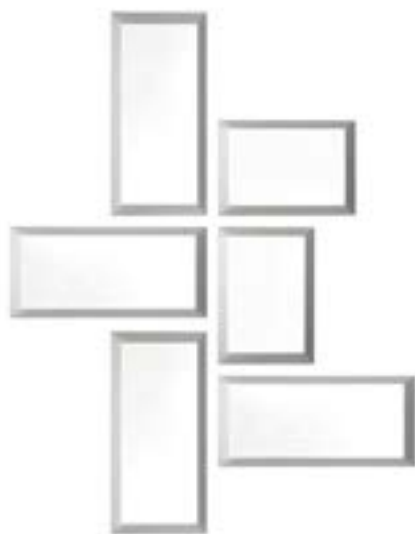



# HECTOR MIRROR

VINCENT VAN DUYSSEN

From the stylistic line of the Hector night system comes Hector Mirror, a mirror dictated by extreme minimalism. Hector Mirror can be hung on the wall or placed on the floor, available in bronze and pewter colour finishes with an aluminium frame. With its contemporary character, it fits into any environment, from the living to the sleeping area.

Dalla linea stilistica del sistema notte Hector nasce Hector Mirror, uno specchio dettato dal minimalismo estremo. Hector Mirror può essere appeso a parete o appoggiato a terra, declinato nelle finiture bronzo e peltro con telaio in alluminio. Con il suo carattere contemporaneo, si posiziona in ogni ambiente, dal living alla zona notte.



D.754.1  
AURA  
DEDALO  
DUNA  
EDGE  
EONE  
HEM  
ORIZZONTI  
PALETTE  
RANDOM  
ROADS  
SONORO  
STRIPE  
TELARO  
VIBRAZIONI

carpet  
collection



# D.754.1

GIO PONTI

Rug of an unusual geometric form, designed in 1954, as a prototype, for the Ponti's house on via Dezza in Milan. Made of "Pony" leather in four colours: white, brown, black, beige.

Tappeto dall'insolita forma geometrica, disegnato nel 1954 come prototipo per la casa Ponti di via Dezza a Milano. Realizzato in pelle di cavallino a quattro colori: bianco, marrone, nero, beige.

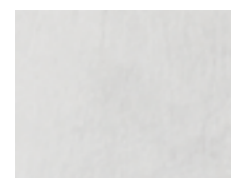

WHITE



BLACK



BROWN



BEIGE



# AURA

NICOLA GALLIZIA

Aura, designed in Italy by Nicola Gallizia for Molteni&C, is a rug produced in the Kathmandu valley in Nepal. The glossy and matt effects achieved by using vegetable silk and wool, which respond differently to the light, produce a refined and subtle monochromatic finish. The border, skillfully finished with scissors, completes the rug and adds a touch of elegance. The entire rug production process is performed by hand, from carding the raw materials to weaving right through to finishing.

Aura firmato da Nicola Gallizia per Molteni&C è un tappeto disegnato in Italia e prodotto nella valle di Kathmandu, Nepal. Gli effetti lucido ed opaco, dati dal contrasto seta vegetale e lana, restituiscono un comportamento diverso alla luce, che rende percepibile la raffinatezza del contrasto monocromatico. La bordura maestralmente realizzata a forbice in fase di finissaggio, completa il tappeto e aggiunge un tocco di eleganza. L'intero processo di produzione del tappeto viene realizzato a mano.



ANTHRACITE

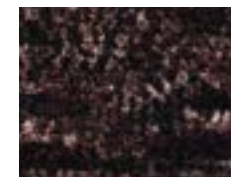

BORDEAUX



JADE



PETROLEUM BLUE



SAGE

	Hand Loom	Telaio a mano
	Height fleece 6 mm	Spessore vello 6 mm
	Height border 3 mm	Spessore bordura 3 mm
Dimensions / Dimensioni	Ngari wool pile	Vello in lana Ngari
300 x 100 cm	rug with a Tibetan wool	e un twill di lana
300 x 250 cm	and viscose	tibetana e viscosa
400 x 300 cm	(or bamboo silk) twill	(o seta vegetale)
Ø 300 cm		



# DEDALO by Pierre Frey

MARTA FERRI

The Dedalo rug is characterised by a rigorous geometry and refined colours that are always the protagonists of the design, harmoniously integrating in the new everyday concept of the home. The project marks the first collaboration with the prestigious Maison Pierre Frey which, with over eighty years of experience, is a leader in the production of wonderful fabrics for curtains and upholstery. The exceptional know-how of Maison Pierre Frey thus combines with Molteni&C's obsession for quality and detail to create a project with an innovative design and strong visual impact.

Dedalo si caratterizza per una geometria rigorosa e da cromie ricercate e sempre protagoniste nel progetto, in grado di integrarsi con armonia al nuovo concetto quotidiano di casa. Il progetto segna una prima collaborazione con la prestigiosa Maison Pierre Frey che, con oltre ottanta anni di storia, è leader nella produzione di meravigliosi tessuti per tendaggi e imbottiti. L'eccezionale know-how della Maison Pierre Frey si unisce così all'ossessione per la qualità e per i dettagli di Molteni&C nella creazione di un progetto innovativo nel design e dal forte impatto visivo.



ORANGE SPARK



SOFT GREY

## Dimensions / Dimensioni

400 x 200 cm  
300 x 300 cm  
400 x 300 cm  
500 x 300 cm

Hand-tufted with carving  
Height fleece 15 mm  
70% Tencel  
30% Wool

Taftato a mano con carving  
Spessore 15 mm  
70% Tencel  
30% Lana



# DUNA

NICOLA GALLIZIA

Inspired by the geometric impermanence of the desert dunes, Duna is made of wool and bamboo platted in various thicknesses to produce the effect of furrows of sand. Its modularity gives rise to an elegant and simple decorative effect. Handcrafted using the manual tufting method, Duna is available in three versions of warm and natural colors: Ivory, Tobacco and Anthracite.

Ispirato all'impermanenza geometrica delle dune del deserto, Duna è realizzato in lana e bambù intrecciati in vari spessori per produrre l'effetto dei solchi di sabbia. La ripartizione in moduli dà vita ad un effetto decorativo all'insegna dell'eleganza e della semplicità. Realizzato artigianalmente con metodo tufting manuale, Duna è disponibile in tre versioni di colori naturali ed accoglienti: Ivory, Tobacco e Anthracite.



ANTHRACITE



TOBACCO



IVORY

Dimensions / Dimensioni  
 400 x 200 cm  
 300 x 300 cm  
 400 x 300 cm  
 500 x 300 cm

Hand-tufted  
 Height fleece 12 mm  
 Density 5 kg/mq  
 75% New Zealand Wool  
 25% Bamboo

Taftato a mano  
 Spessore 12 mm  
 Peso 5 kg/mq  
 75% New Zealand Wool  
 25% Bamboo



# EDGE

NICOLA GALLIZIA

Wool and linen, materials from the most sophisticated tradition of carpet manufacturing, mixed in a new way for a new soft and bright feel. The conventional edge of the carpet, which frames the central field, reinvents the decoration using the colours of our memory. It is a return to simple and elegant chromatic lines.

Lana e lino, materia della più sofisticata tradizione del tappeto, mescolate in maniera nuova diventano una inedita superficie morbida e luminosa. Il tradizionale bordo del tappeto che riquadra la campitura centrale, reinventa la decorazione utilizzando colori della memoria riportandola a segno grafico e cromatico semplice ed elegante.



BLUE GRADIENT BORDER



BROWN GRADIENT BORDER



GREEN GRADIENT BORDER



MOON GRADIENT BORDER



ROSE GRADIENT BORDER

Dimensions / Dimensioni	Hand-tufted	Taftato a mano
300 x 300 cm	Height fleece 18 mm	Spessore 18 mm
400 x 300 cm	Gradient border 40 cm	Gradiente bordo 40 cm
500 x 300 cm	80% Mohair wool	80% Lana mohair
Ø 500 cm	20% Linen	20% Lino



# EONE

NICOLA GALLIZIA

Eone offers a luxurious long-pile rug that enchants with its tactile allure and creates an irresistibly inviting ambiance. Crafted exclusively from 100% bamboo yarn, renowned for its refreshing qualities and minimal ecological footprint, Eone delivers a sensorial experience like no other.

Eone offre una raffinata opzione di tappeto a pelo lungo, piacevole al tatto in ogni stagione e apprezzato per l'irresistibile atmosfera di accoglienza che sa creare. La sensoriale esperienza tattile di questo tappeto è resa possibile grazie al filato esclusivamente in bambù al 100%, una materia prima nota per le sue qualità di freschezza e sempre più ricercata per il suo ridotto impatto ecologico.



SAND



BARK



IVORY



EBONY

#### Dimensions / Dimensioni

400 x 200 cm

400 x 300 cm

500 x 400 cm

Custom / Su misura

Hand-tufted

Height fleece 3 cm

Density 5,5 kg/mq

100% Bamboo

Taftato a mano

Spessore 3 cm

Densità 5,5 kg/mq

100% Bamboo





# HEM by G.T.Design

PATRICIA URQUIOLA

Rugs return to their original purpose as islands or places where people sit down together and forget their daily worries. Always different, they express a blend of the highest western creativity and ancient Asian craft traditions. From the long-standing partnership between Molteni&C and Patricia Urquiola, a new family of products. This combination uses natural materials to create a harmonious rug collection.

Il tappeto ritorna all'antica funzione di isola, dove ritrovarsi e dimenticare gli affanni quotidiani. Sempre diverso, perché frutto dell'incontro tra la più alta creatività occidentale e la millenaria artigianalità asiatica. La lunga collaborazione tra Molteni&C e Patricia Urquiola si arricchisce di una nuova famiglia di prodotti. Ed è proprio questo incontro, unito a materiali naturali a dar vita a una collezione di tappeti di grande armonia.



STONE



SAND

Dimensions / Dimensioni	Hand knotted	Realizzati a mano
300 x 250 cm	Height fleece 6 mm	Spessore 6 mm
400 x 300 cm	Density	Densità
Ø 250 cm	86.000 knots/mq	86.000 nodi/mq
	100% Bamboo silk	100% Bamboo silk



# ORIZZONTI

MARTA FERRI

Horizons is a tufted wool rug without fringe, characterized by a weave of varying lengths creating a design that recalls the succession of landscapes to the horizon. It is a soft rug with a unique design, perfect for enriching any environment. Customizable size according to the client's needs.

Orizzonti è un tappeto taftato in lana senza frange caratterizzato da una trama con varie lunghezze creando un disegno che ricorda il susseguirsi di paesaggi all'orizzonte. È un tappeto morbido e dal design unico, adatto ad arricchire ogni ambiente. • Dimensione personalizzabile a seconda delle esigenze del cliente.



IVORY



OCHRE



352 | 353

#### Dimensions / Dimensioni

400 x 200 cm  
300 x 300 cm  
400 x 300 cm  
500 x 400 cm

Woven on loom  
Height fleece 6 mm  
Density 2,5 kg/mq  
100% Wool

Tessuto a telaio  
Spessore 0,6 cm  
Peso 2,5 kg/mq  
100 % Lana



# PALETTE

NICOLA GALLIZIA

A collection consisting of matter and colour, the decorative peculiarity of these carpets is their essential elegance. The vibrato depth of colour creates a soft and enveloping effect that functions as ordering element of space.

È una collezione costruita di materia e colore, cifra decorativa di questi tappeti eleganti proprio perché essenziali. Il vibrato del colore crea un effetto morbido e avvolgente che accoglie e diventa elemento ordinatore dello spazio.



CREAM



DOVE GREY



ANTHRACITE



TAUPE



BORDEAUX



PETROLEUM BLUE

Dimensions / Dimensioni

- 300 x 300 cm
- 400 x 300 cm
- 500 x 300 cm

- Hand-tufted
- Height fleece 18 mm
- 100% Tencel

- Taftato a mano
- Spessore 18 mm
- 100% Tencel

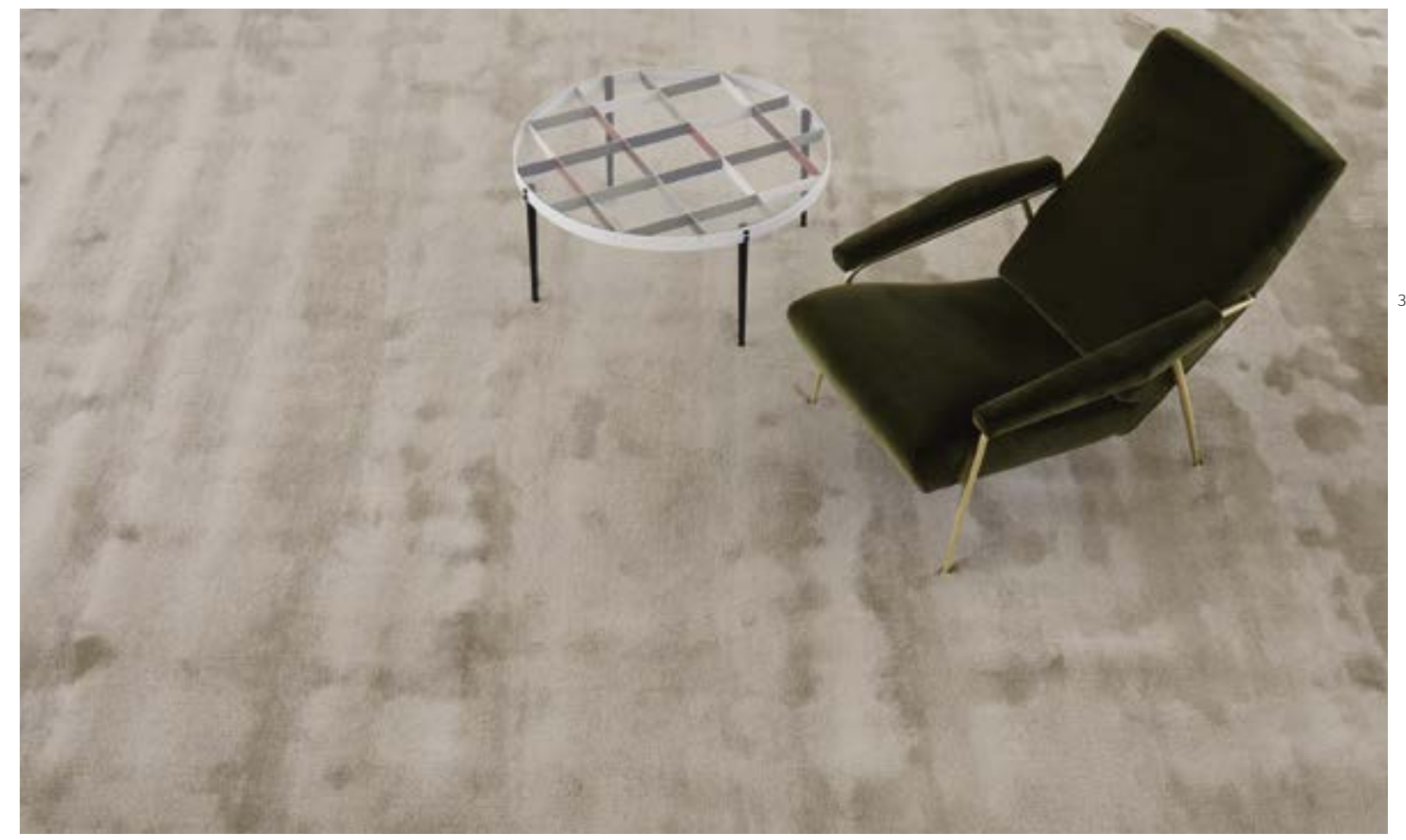

# RANDOM by Altai

PATRICIA URQUIOLA

The charm of an ancient rug, with its marked individuality and well-worn look, is the source of inspiration for Random. The well-worn look is the key feature, expressing itself in an original exaltation of the texture of the rug, created with an innovative hand-woven technique, which highlights the structure of the weave.

Il fascino del tappeto antico con la sua spiccata individualità e il suo aspetto vissuto è la fonte di ispirazione che ha portato alla creazione di Random. Il vissuto a cui si ispira, diventa l'elemento caratterizzante esprimendosi in una originale esaltazione della trama del tappeto creata attraverso una innovativa tecnica di lavorazione a mano che mette in rilievo la struttura del tessuto.



ARTIC



PLATINUM



POWDER PINK

	Hand knotted	Annodato a mano
	Height fleece 12/14 mm	Spessore 12/14 mm
	Density	Densità
Dimensions / Dimensioni	40.000 knots/mq	40.000 nodi/mq
300 x 200 cm	80 % Bamboo silk,	80% Bamboo silk,
400 x 300 cm	10 % Cotton, 10% Wool	10% Cotone, 10% Lana
Ø 300 cm	Backing: natural latex	Appoggio: lattice naturale



# ROADS

MARTA FERRI

The Roads rug is a fringeless flat wave knotted rug. The checkered design in two colors, in shades of green, ivory, black, and blue, is interrupted at intervals by contrasting stripes, like roads cutting through the landscape, enriching the decor. Customizable size according to the client's needs.

Il tappeto Roads è un tappeto annodato flat-wave senza frange. Il disegno a scacchi in due colori, nei toni del green, ivory, black e blue è interrotto a tratti da righe a contrasto, come delle strade che solcano il paesaggio arricchendo il decoro. Dimensione personalizzabile a seconda delle esigenze del cliente.

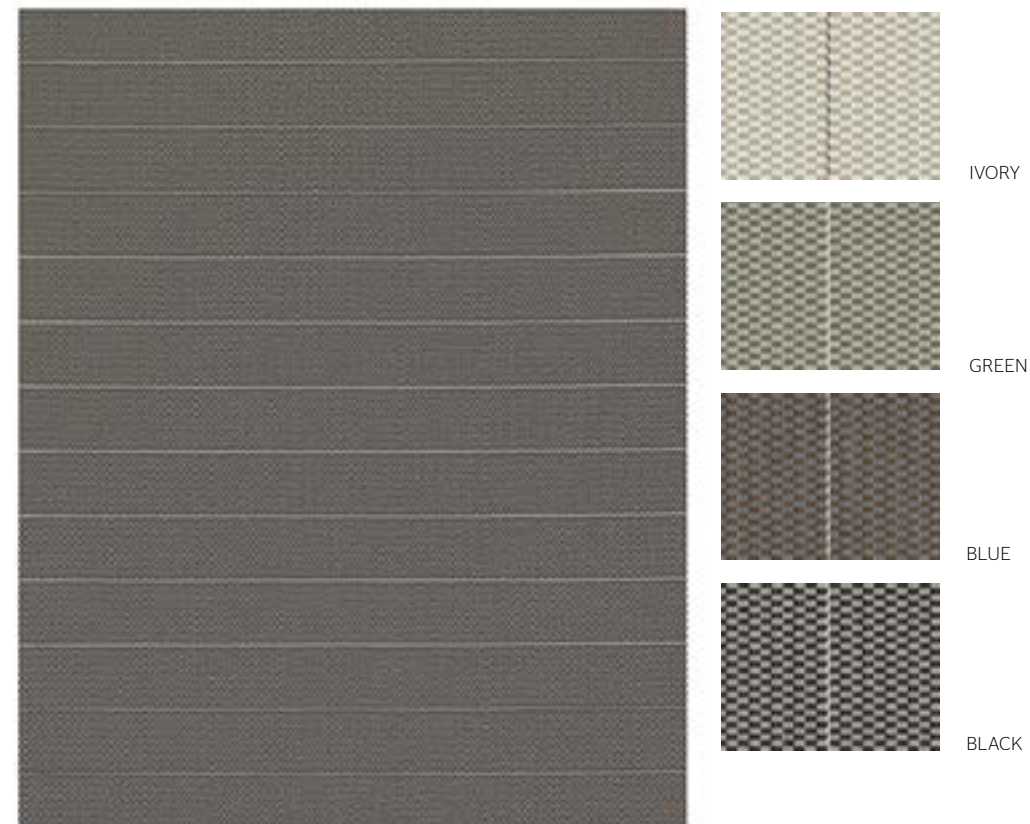

Dimensions / Dimensioni	Woven on loom	Tessuto su telaio
300 x 200 cm	Height fleece 6 mm	Spessore 6 mm
340 x 240 cm	Density 2.5 kg/mq	Peso 2.5 kg/mq
400 x 300 cm	100% New Zealand wool	100% Lana neozelandese
500 x 370 cm	with non-slip latex back	con retro in lattice antiscivolo

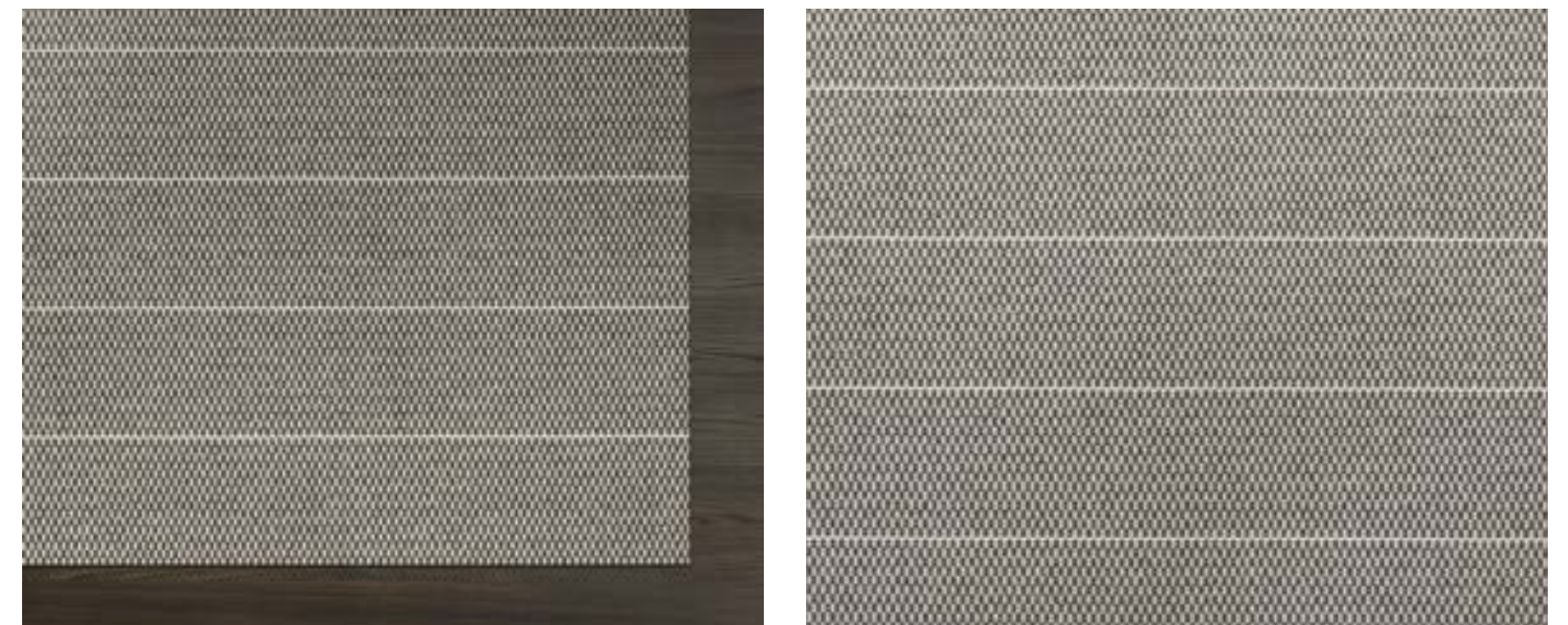
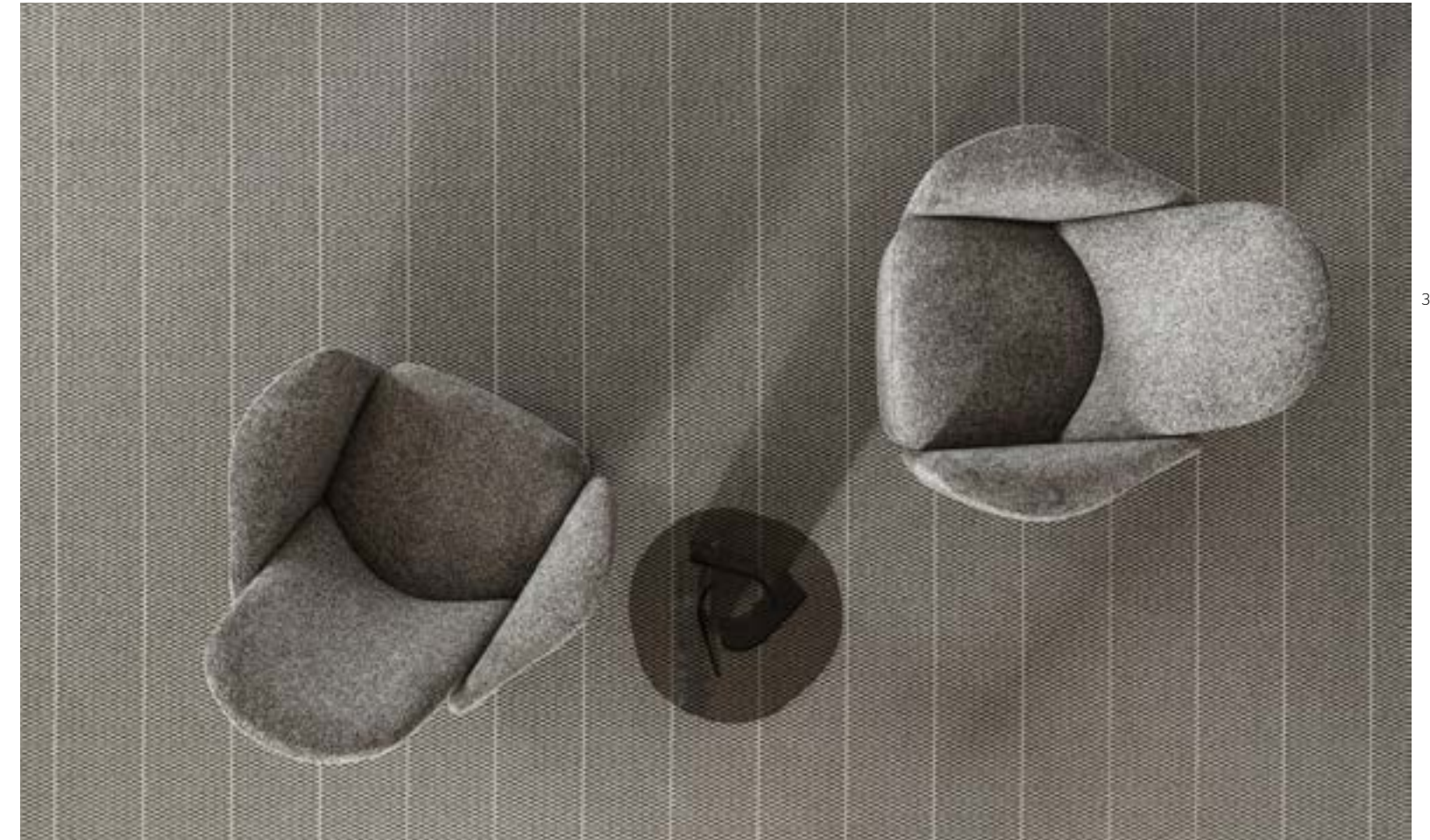

# SONORO

NICOLA GALLIZIA

Fashioned from wool yarn and cotton, it boasts a luxuriously soft and inviting texture, perfectly suited for a variety of indoor environments. Sonoro captivates with its intricate pattern of slender rectangles, reminiscent of gracefully dancing piano keys. In the monochromatic rendition, the key illusion is heightened by the meticulous alignment and alternating knot directions during the loom process, resulting in varied pile heights and a mesmerizing interplay of light and shadow. Meanwhile, the two-tone version accentuates the decorative allure through a harmonious color contrast.

Realizzato in pregiato filato di lana e cotone, questo tappeto offre una mano morbida e avvolgente, risultando ideale per svariate ambientazioni interne. Sonoro si distingue per la sua caratteristica trama di sottili rettangoli sullo sfondo, evocando l'immagine di tasti di pianoforte che danzano in armonia. Nella versione monocromatica, la sensazione dei tasti è sottolineata dalla particolare inclinazione e cambio di direzione dei nodi durante la lavorazione su telaio, generando una variazione di altezze del pelo e un affascinante gioco di riflessi alla luce. La versione bicolore, invece, enfatizza ulteriormente l'effetto decorativo attraverso il contrasto cromatico scelto.



IVORY



EBONY



ASH

#### Dimensions / Dimensioni

300 x 200 cm	Hand-woven on loom	Tessuto a mano su telaio
400 x 300 cm	Height fleece 0,6/0,8 cm	Spessore 0,6/0,8 cm
400 x 400 cm	Density 3 kg/mq	Peso 3 kg/mq
500 x 400 cm	80% Wool	80% Lana
Custom / Su misura	20% Cotton	20% Cotone



# STRIPE

VINCENT VAN DUYSSEN

The sophisticated beauty of these soft surfaces is the result of a deliberate contrast between the simplicity of the design and decorative detail and the richness of the material. Slender alternating stripes of wool and silk create geometric backgrounds in shades of tone-on-tone colours that delicately reflect the light. Harmonious balance between rigour and form.

La sofisticata bellezza di queste morbide superfici nasce dal voluto contrasto tra essenzialità del disegno e del dettaglio decorativo e la ricchezza della materia. Sottili righe alternate di lana e seta creano campiture geometriche in nuances di colori tono su tono che riflettono delicatamente la luce. Armonioso equilibrio tra rigore e forma.



CREAM GREY

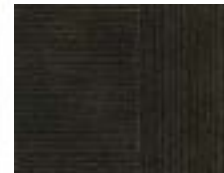

MILITARY GREEN



MINT GREEN

## Dimensions / Dimensioni

500 x 400 cm

400 x 300 cm

300 x 300 cm

400 x 200 cm

Hand-tufted

Height fleece 14 mm

50% Wool, 50% Tencel

Taftato a mano

Spessore 14 mm

50% Lana, 50% Tencel



# TELARO by Amini

MARTA FERRI

Telaro is a rug featuring a geometric motif and a linear pattern. A series of spaces arranged regularly with each other, featuring different sizes and orientations which thus define a contrasting grid. The precious semi-combed wool rug features a woven surface distinguished by a play of reliefs, achieved by means of skilled craftsmanship through hand loom.

Dal motivo geometrico e lineare nasce il tappeto Telaro. Un susseguirsi di spazi disposti regolarmente tra loro, caratterizzati da diverse grandezze e orientamenti che definiscono così una griglia a contrasto. Il tappeto, in preziosa lana semi pettinata, presenta una superficie intrecciata e contraddistinta da un gioco di rilievi, ottenuti da un'abile tecnica artigianale: la realizzazione tramite telaio manuale.



ANTHRACITE



COGNAC



NATURAL

## Dimensions / Dimensioni

400 x 200 cm  
300 x 300 cm  
400 x 300 cm  
500 x 300 cm

Hand loomed  
Height fleece 6/7 mm  
Density 3,4 kg/mq  
Semi worsted wool

Intelaiato a mano  
Spessore 6/7 mm  
Peso 3,4 kg/mq  
Lana semi pettinata

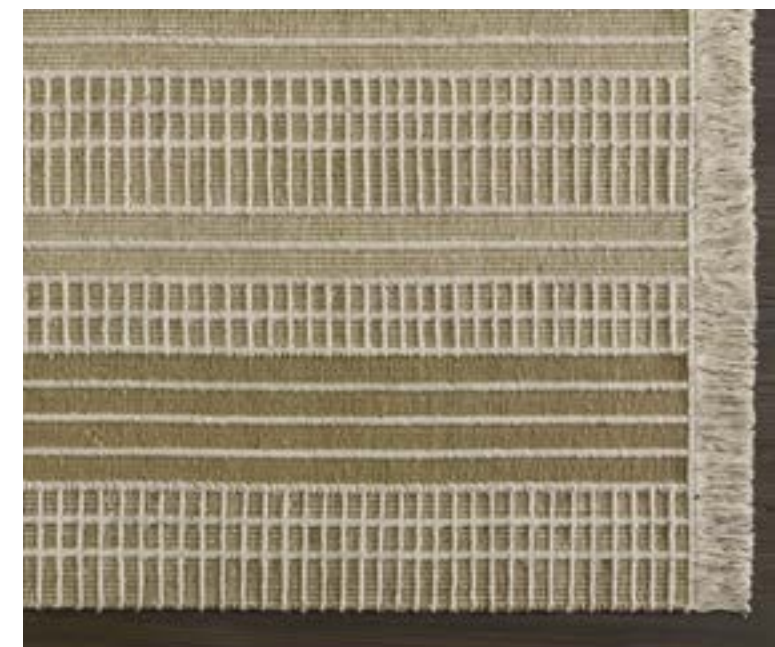



# VIBRAZIONI Frammenti Collection

MARTA FERRI

Constantly changing scenarios give rise to Vibrazioni. A visual and tactile interplay, thanks to differing thicknesses and weaves on different levels that characterize the whole surface of the rug. Interplays of light and shade favoured by a glossy fibre such as rayon, skillfully combined dyes that vary according to the light.

Scenari in trasformazione in continuo cambiamento, dai quali nasce Vibrazioni. Un gioco optical visivo e tattile, grazie agli spessori e tra mature su diversi livelli che ne caratterizzano l'intera superficie del tappeto. Giochi di luci e ombre favoriti da una fibra lucente qual'è il rayon, poche tinte sapientemente ricercate che variano a seconda della luce.



ICE



GRANITE



CLAY



GEM



EARTH



OBSIDIAN

## Dimensions / Dimensioni

300 x 300 cm

400 x 200 cm

400 x 300 cm

500 x 400 cm

Hand-tufted

Height fleece 16/22 mm

100% Bamboo

Taftato a mano

Spessore 16/22 mm

100% Bamboo





# Molteni&C

## Finishes guideline

The “finishes guideline” document aims to guide the user through the available finishes for the main living and night systems and all the available finishes in real sample. We strongly suggest to build your projects looking to the dedicated price lists for living and night systems.

Il documento “finishes guideline” si propone come una guida esemplificativa delle finiture disponibili per i principali sistemi giorno e notte e per tutte le finiture prodotte in campione reale. Per tutti i dettagli in merito alla strutturazione del progetto, consigliamo la consultazione del corrispettivo listino giorno o notte.

**SAMPLE AVAILABLE**

Physical sample available and ready to order

**CAMPIONE DISPONIBILE**

Campione fisico disponibile e ordinabile

# INDOOR FINISHES OVERVIEW\*

## OVERVIEW FINITURE INDOOR\*

<input checked="" type="checkbox"/> SAMPLE AVAILABLE	*NEW 2025	GLOSSY LACQUERED	MATT LACQUERED	3D SPECIAL MATT LACQUERED SAMPLE ONLY 3D COPPER	COLOURED GLASS NO SAMPLES AVAILABLE	ETCHED COLOURED GLASS NO SAMPLES AVAILABLE
WHITE L001 Only Arial		•	•			
CHALK WHITE BC	<input checked="" type="checkbox"/>	•	•	•	•	•
ALMOND WHITE AW	<input checked="" type="checkbox"/>	•	•	•	•	•
PEARL PE	<input checked="" type="checkbox"/>	•	•	•	•	•
SILICA SI	<input checked="" type="checkbox"/>	•	•	•	•	•
SAND SA	<input checked="" type="checkbox"/>	•	•	•	•	•
DOVE GREY TO	<input checked="" type="checkbox"/>	•	•	•	•	•
PLATINUM PL	<input checked="" type="checkbox"/>	•	•	•	•	•
LONDON SKY LS	<input checked="" type="checkbox"/>	•	•	•	•	•
DUNE DN	<input checked="" type="checkbox"/>	•	•	•	•	•
IRIS IX	<input checked="" type="checkbox"/>	•	•	•	•	•
CAPPUCCINO CP	<input checked="" type="checkbox"/>	•	•	•	•	•
CLAY AL	<input checked="" type="checkbox"/>	•	•	•	•	•
DOLOMITE GREY DO	<input checked="" type="checkbox"/>	•	•	•	•	•
COPPER RX	<input checked="" type="checkbox"/>	•	•	•	•	•
RUBY RU	<input checked="" type="checkbox"/>	•	•	•	•	•
BURGUNDY BG	<input checked="" type="checkbox"/>	•	•	•	•	•

 The document aims to show all the finishes produced, highlighting if the real sample is available or not. For every detail and usage of each finish you must look at the dedicated price list. Colors are to be considered as purely indicative.  
Il documento è una guida a tutte le finiture prodotte con indicazione della presenza o meno del campione reale. Per ogni dettaglio relativo all'applicazione delle finiture su vari prodotti, bisogna fare riferimento esclusivamente ai listini. I colori sono puramente indicativi.

\* kitchen and outdoor collections excluded  
\* collezioni cucine e outdoor escluse

	GLOSSY LACQUERED	MATT LACQUERED	3D SPECIAL MATT LACQUERED SAMPLE ONLY 3D COPPER	COLOURED GLASS NO SAMPLES AVAILABLE	ETCHED COLOURED GLASS NO SAMPLES AVAILABLE
MOKA MK	•	•	•	•	•
MUSTARD SE	•	•	•	•	•
OZ YELLOW OY ✿	•	•	•	•	•
SPICE SP	•	•	•	•	•
LIGHT GREY LO06 Only Arial	•	•	•	•	•
STARDUST SU	•	•	•	•	•
MOONLIGHT ML	•	•	•	•	•
LIGHT BLUE GREY CZ	•	•	•	•	•
DARK BLUE GRAY DB ✿	•	•	•	•	•
PETROLEUM BLUE PR	•	•	•	•	•
PEWTER PX	•	•	•	•	•
LEAD LO63 Only Arial	•	•	•	•	•
ANTHRACITE AT	•	•	•	•	•
PINE GREEN PG	•	•	•	•	•
FOREST GREEN FG ✿	•	•	•	•	•
BLACK NE	•	•	•	•	•

Overlay etched or transparent glass sample onto any laquer sample to get the effect of the corresponding coloured etched or coloured glass.  
Sovrapporre un campione di vetro trasparente o acidato su qualsiasi campione laccato per ottenere l'effetto del corrispondente vetro colorato acidato o vetro colorato.

# INDOOR FINISHES OVERVIEW\*

## OVERVIEW FINITURE INDOOR\*

☑ SAMPLE AVAILABLE

\*NEW 2025

### SPECIAL LACQUERED



### WOODS

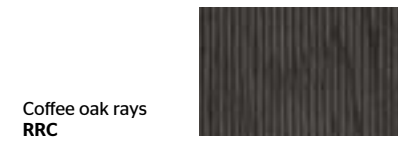
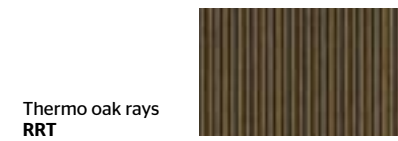
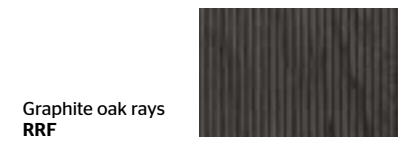
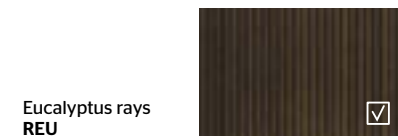
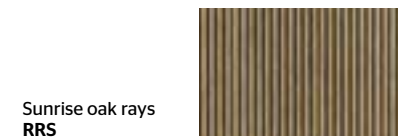
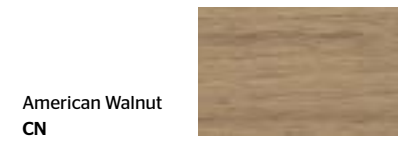
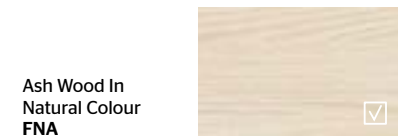

### METAL PARTS



⚠ The document aims to show all the finishes produced, highlighting if the real sample is available or not. For every detail and usage of each finish you must look at the dedicated price list. Colors are to be considered as purely indicative.  
Il documento è una guida a tutte le finiture prodotte con indicazione della presenza o meno del campione reale. Per ogni dettaglio relativo all'applicazione delle finiture su vari prodotti, bisogna fare riferimento esclusivamente ai listini. I colori sono puramente indicativi.

\* kitchen and outdoor collections excluded  
\* collezioni cucine e outdoor escluse



### MARBLES

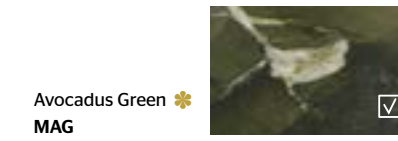
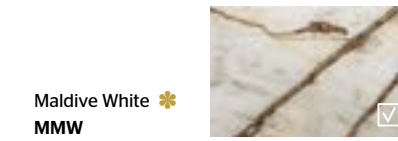
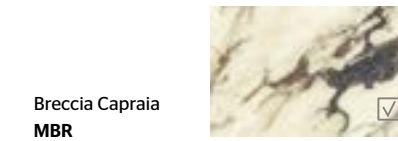
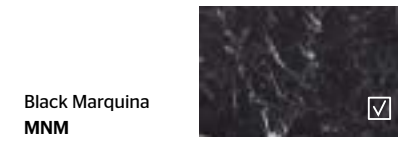
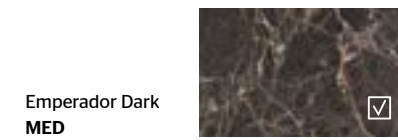
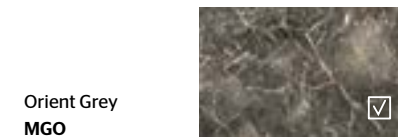
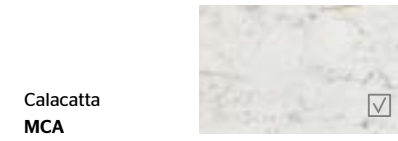
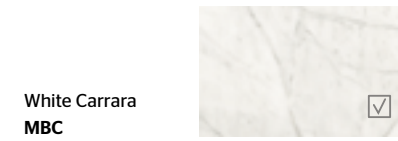

### LAVA STONE

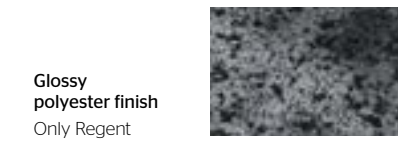

### CERAMIC

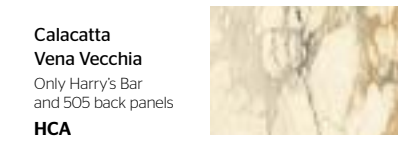

### CEMENT

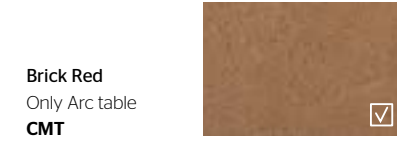







# INDOOR FINISHES OVERVIEW\*

## OVERVIEW FINITURE INDOOR\*

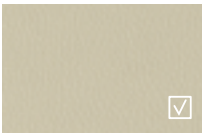
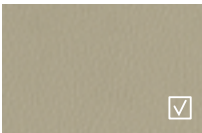







☑ SAMPLE AVAILABLE

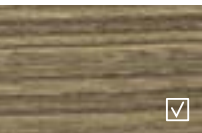



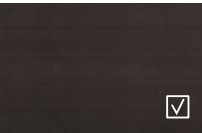

\*NEW 2025

### ECO SKIN

Ivory ESAV	
Hemp ESCA	
Mink ESVI	
Earth ESTE	
Artic ESAC	
Taupe ESTA	
Grey ESGR	
Dark Brown ESTM	

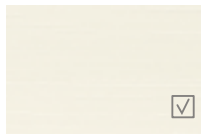
### MELAMINE

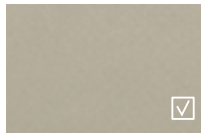
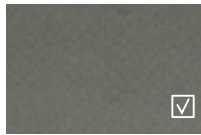
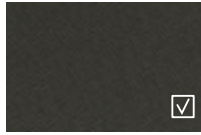
Silver cembran YA	
Light Chestnut QC	
Dark Chestnut QS	
Grey Tatami QG	
Ivory Tatami QA	
White WW	
Fine grain FG1	
Piqué XQ	
Lunar JLU	
Sunrise Chestnut ✨ YC	

Silk Chalk White ZB	
Silk Silica ZS	
Silk Dove Grey ZT	
Cartapaglia white KB	
Cartapaglia silica KS	
Cartapaglia anthracite KA	
Batik Ecrú XE	
Batik Slate XA	
Grey Saffiano	
Ecrú Saffiano	











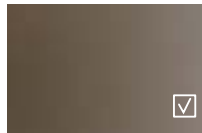









The document aims to show all the finishes produced, highlighting if the real sample is available or not. For every detail and usage of each finish you must look at the dedicated price list. Colors are to be considered as purely indicative.

Il documento è una guida a tutte le finiture prodotte con indicazione della presenza o meno del campione reale. Per ogni dettaglio relativo all'applicazione delle finiture su vari prodotti, bisogna fare riferimento esclusivamente ai listini. I colori sono puramente indicativi.







\* kitchen and outdoor collections excluded  
\* collezioni cucine e outdoor escluse

### GLASSES

Bronze mirror SPB	
Transparent VTR	
Smoked VTFU	
Etched glass VA	
3D etched bronze V3BZ	
Graphene Only Diamond VTRR	
Bronze VBO	
Textured green Only Aster VRVE	
Textured smoked Only Aster VRFU	
Bronze Textured Glass Only Fleur	

Transparent Stopsol VTSR	
Etched Stopsol VTST	
Stopsol Net VTSN	
Stopsol Bronze VTSB	
Stopsol Silver VTSS	
<b>ECOTONE</b>	
Sienna ✨ Only Diamond and Filigree MYSI	
Poseidon ✨ Only Diamond and Filigree MYPO	
<b>MDI BY INALCO</b>	
Gray Brown ✨ Only Arial and Gliss Master ZGB	
Merino White ✨ Only Arial and Gliss Master ZMW	

### BLEND COLLECTION Mini fabric format samples

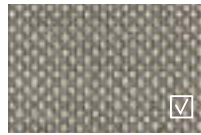
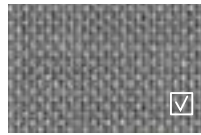
Vanilla Only Gliss Master, Logos and Arial TEVA	
Bark Brown Only Gliss Master, Logos and Arial TEBB	
Olive Green Only Gliss Master, Logos and Arial TEOG	
Moss Green Only Gliss Master, Logos and Arial TEMG	
Hay ✨ Only Gliss Master, Logos and Arial TEHA	
Moon ✨ Only Gliss Master, Logos and Arial TEMO	
Malachite ✨ Only Gliss Master, Logos and Arial TEMA	
River Rocks ✨ Only Gliss Master, Logos and Arial TERR	
Storm ✨ Only Gliss Master, Logos and Arial TEST	



TECHNICAL DRAWINGS  
DISEGNI TECNICI



ARC FOSTER + PARTNERS

ROUND TABLES  
TAVOLI ROTONDI

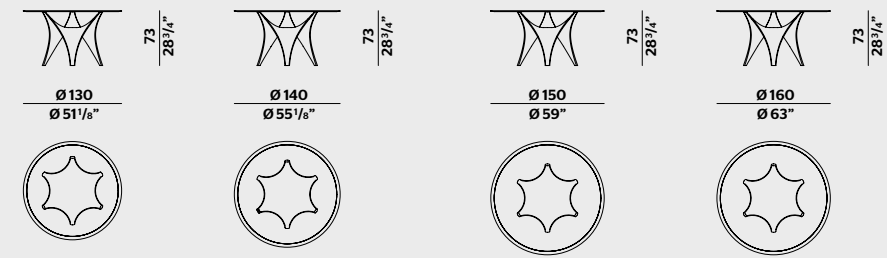

OVAL TABLES  
TAVOLI OVALI

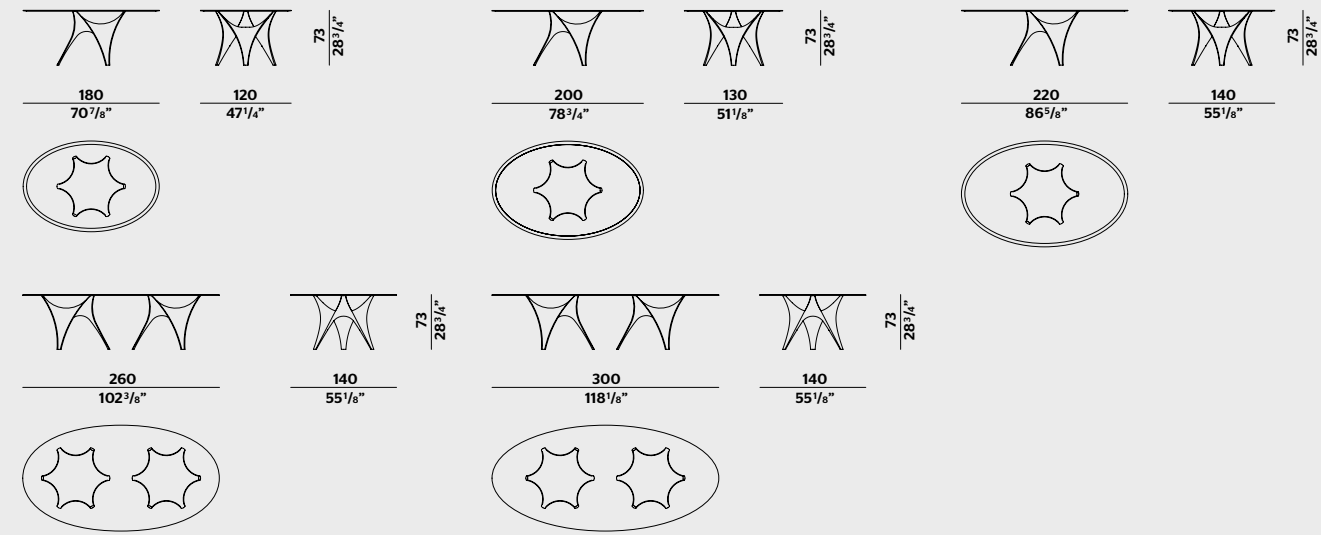

ASTERIAS PATRICIA URQUIOLA

ROUND TABLES  
TAVOLI ROTONDI

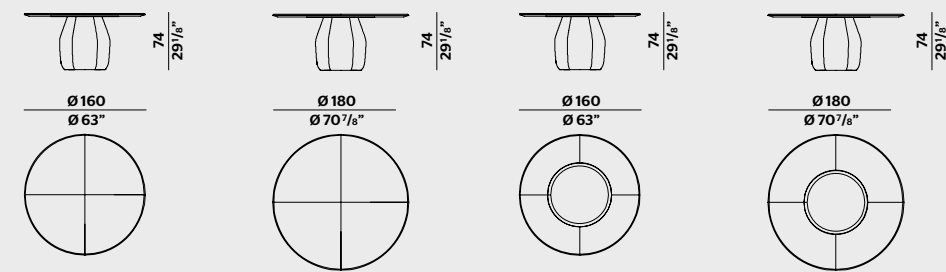

ROUND TABLES WITH LAZY SUSAN  $\varnothing$  33 1/2"  
TAVOLI ROTONDI CON PIATTO GIREVOLE  $\varnothing$  85

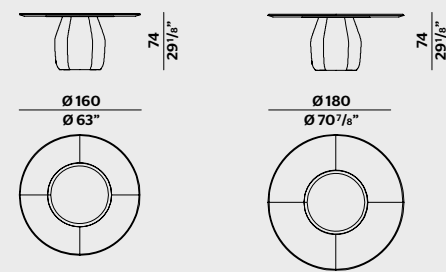

AVA TABLE FOSTER + PARTNERS

RECTANGULAR TABLES  
TAVOLI RETTANGOLARI

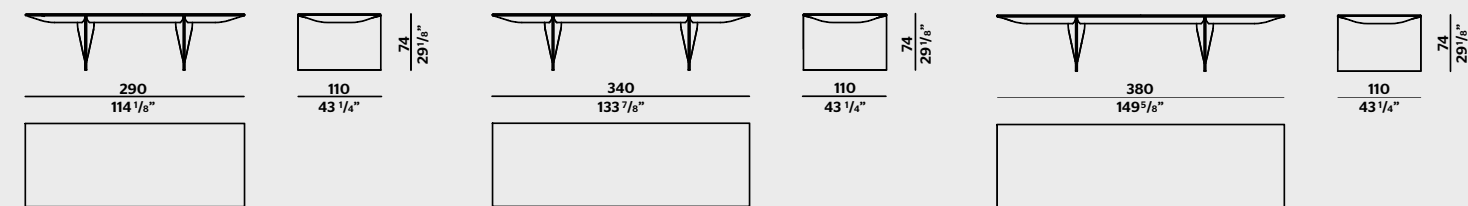

BLEVIO IGNAZIO GARDELLA

TABLE  
TAVOLO

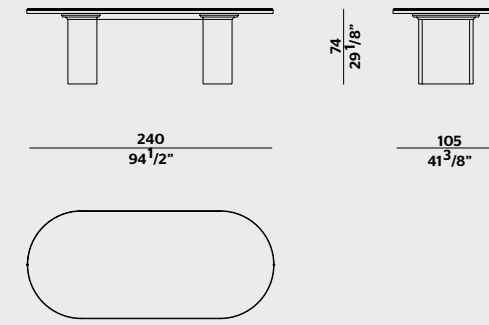

TABLE  
TAVOLO

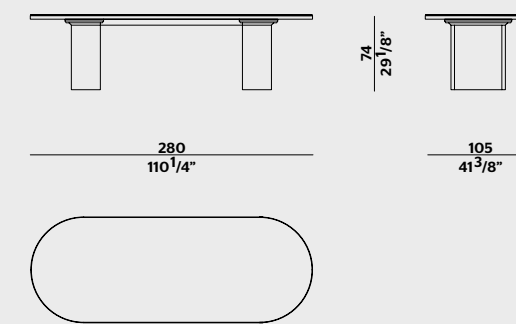
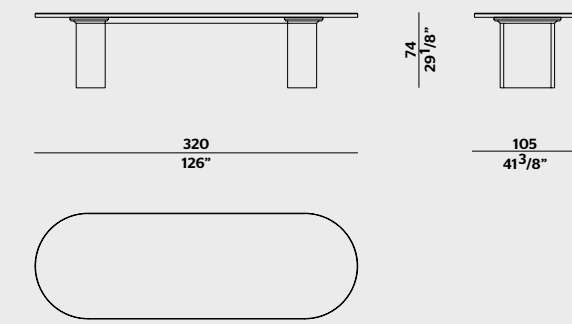

TABLE  
TAVOLO



D.859.1 GIO PONTI

TABLE  
TAVOLO

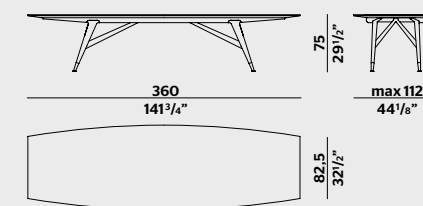

TABLE  
TAVOLO

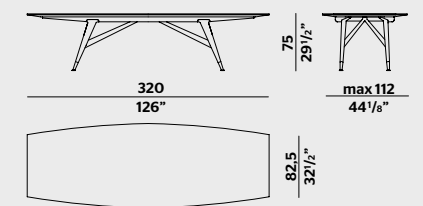
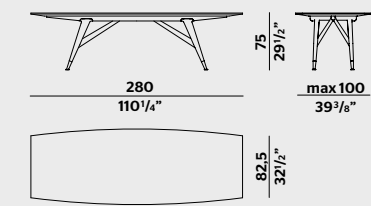
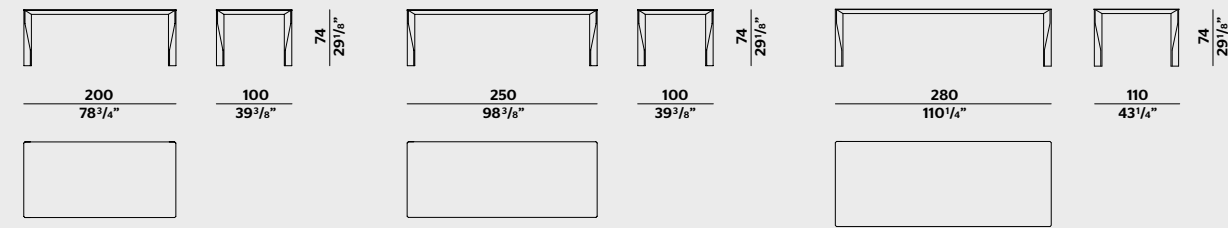

TABLE  
TAVOLO



DIAMOND PATRICIA URQUIOLA

RECTANGULAR TABLES  
TAVOLI RETTANGOLARI



SQUARE TABLES  
TAVOLI QUADRATI

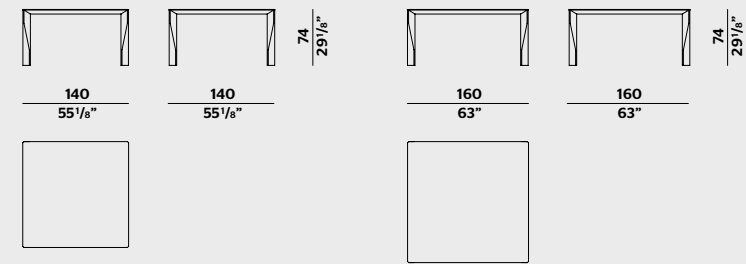

FILIGREE RODOLFO DORDONI

RECTANGULAR EXTENDABLE TABLE  
TAVOLO RETTANGOLARE ALLUNGABILE

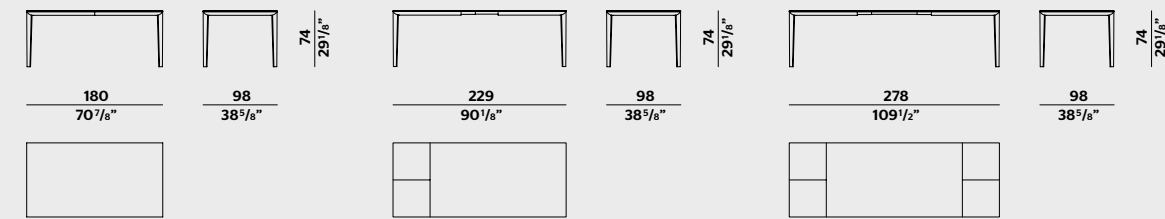

FIXED RECTANGULAR TABLES  
TAVOLI RETTANGOLARI FISSI

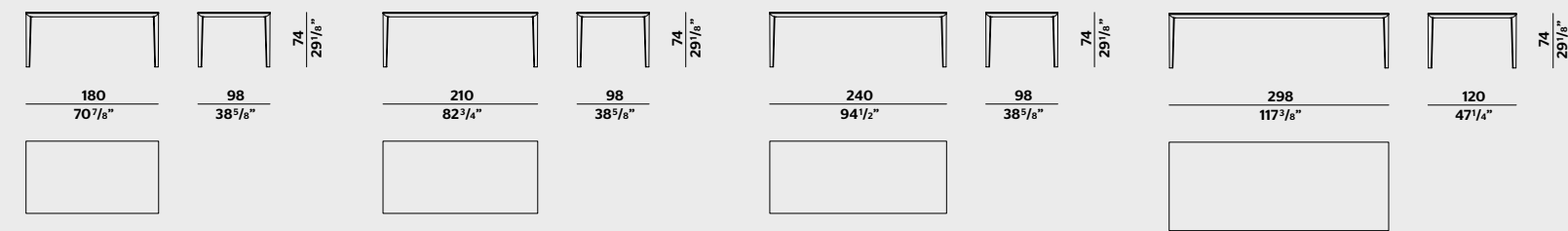

GATWICK RODOLFO DORDONI

OVAL TABLE  
TAVOLO OVALE

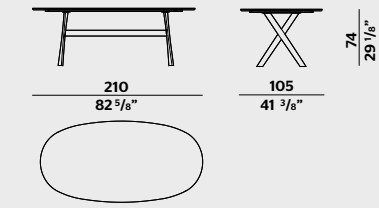

OVAL TABLES  
TAVOLI OVALI

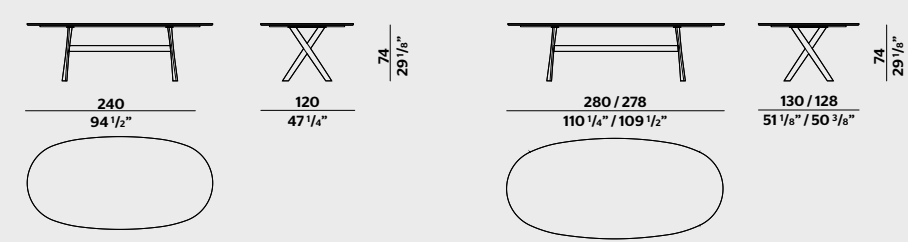

HALF A SQUARE MICHAEL ANASTASSIADES

SQUARE TABLE  
TAVOLO QUADRATO

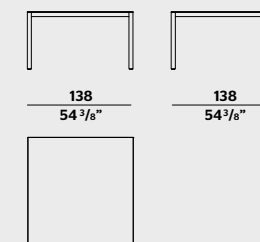

RECTANGULAR TABLES  
TAVOLI RETTANGOLARI

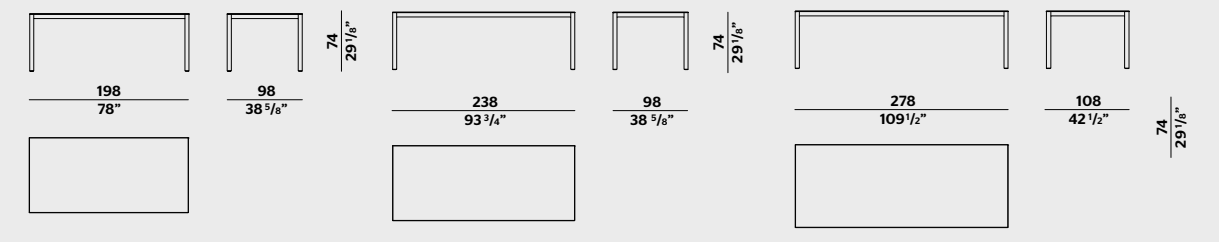

LISE CHRISTOPHE DELCOURT

GLOSSY LACQUERED STRUCTURE AND EDGE WITH WOOD TOP TABLES  
TAVOLI STRUTTURA E BORDO LACCATO LUCIDO CON PIANO ESSENZA

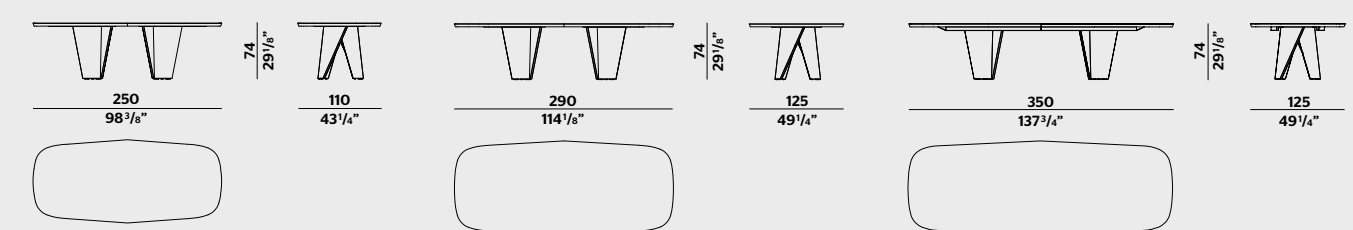

STRUCTURE AND SHINY STEEL FRAME WITH STONE OR WOOD INSERT  
TAVOLI STRUTTURA E CORNICE ACCIAIO LUCIDO CON INSERTO PIETRA O ESSENZA

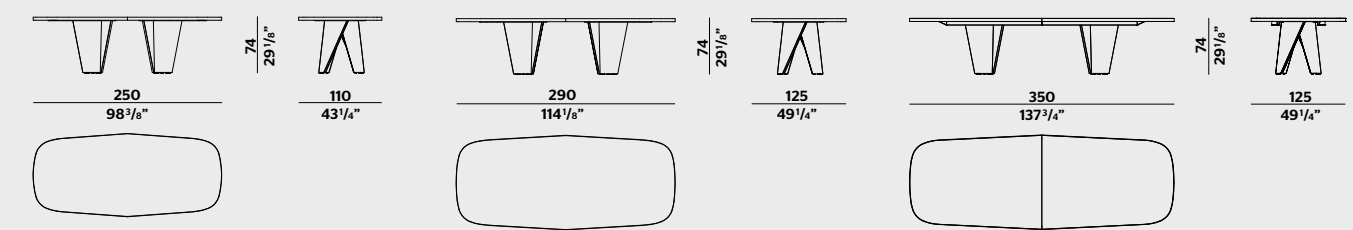



MATEO VINCENT VAN DUYSSEN

ROUND DINING TABLES  
TAVOLI DINING ROTONDI

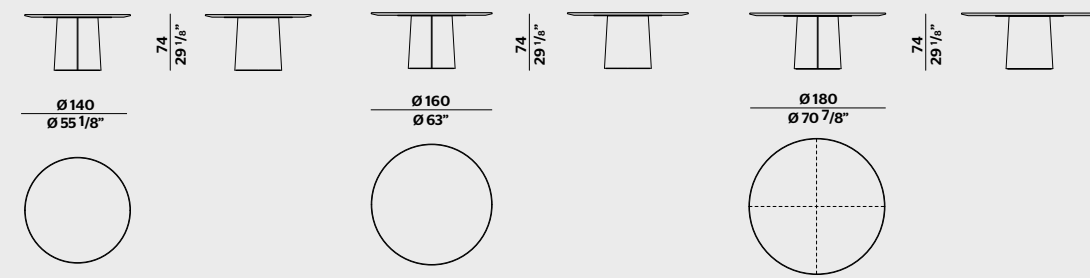

ROUND DINING TABLES  
TAVOLI DINING ROTONDI

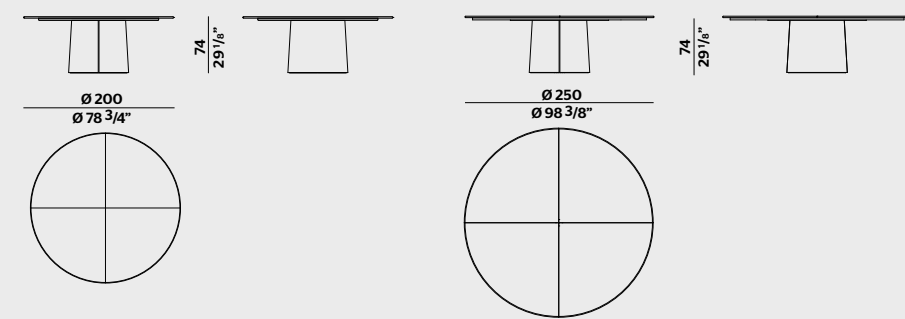

OVAL DINING TABLES  
TAVOLI DINING OVALI

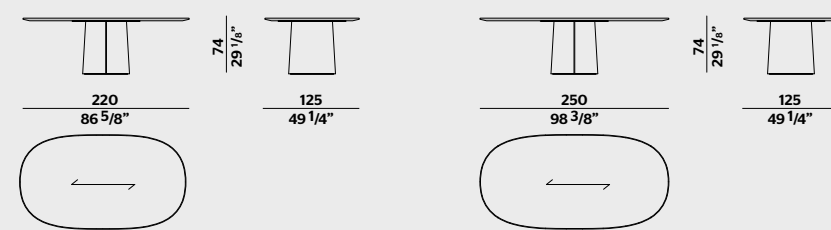

ROUND LOUNGE TABLES H 64  
TAVOLI LOUNGE ROTONDI H 64

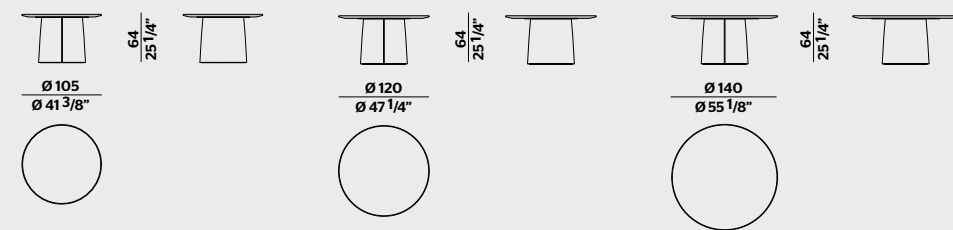

OVAL DINING TABLES WITH DOUBLE BASE  
TAVOLI DINING OVALI CON DOPPIA BASE

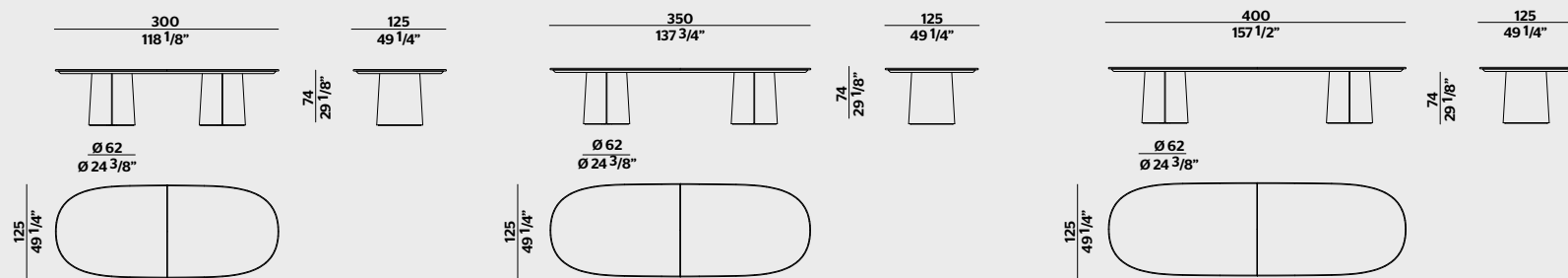

ROUND LOUNGE TABLE H 74  
TAVOLO LOUNGE ROTONDO H 74

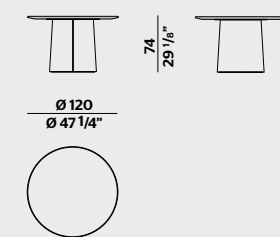

OLD FORD RODOLFO DORDONI

WOODEN TABLES  
TAVOLI ESSENZA

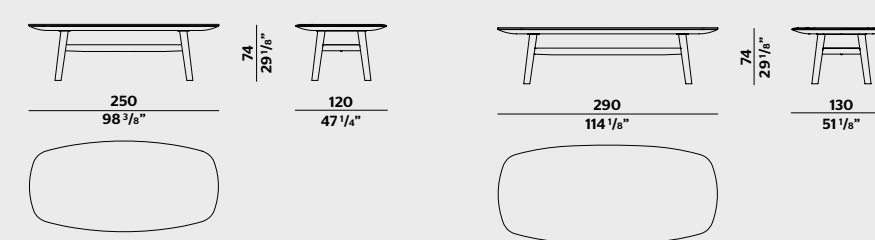

MARBLE TABLES  
TAVOLI MARMO

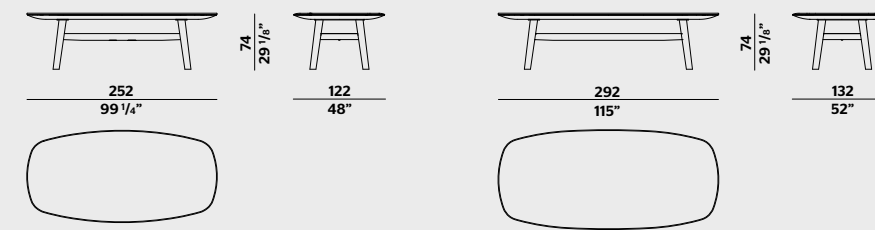

MARBLE TABLE  
TAVOLO MARMO

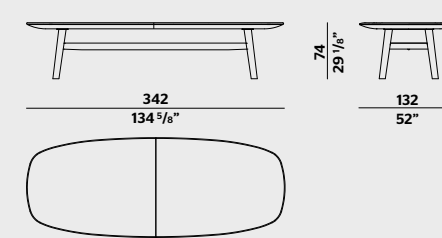

PÉNÉLOPE CHRISTOPHE DELCOURT

GLOSSY LACQUERED STRUCTURE AND EDGE WITH WOOD TOP CONSOLES  
CONSOLLE STRUTTURA E BORDO LACCATO LUCIDO CON PIANO ESSENZA

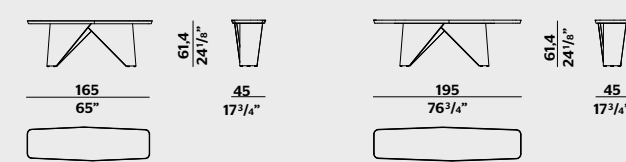

STRUCTURE AND SHINY STEEL FRAME WITH STONE OR WOOD INSERT CONSOLES  
CONSOLLE STRUTTURA E CORNICE ACCIAIO LUCIDO CON INSERTO PIETRA O ESSENZA

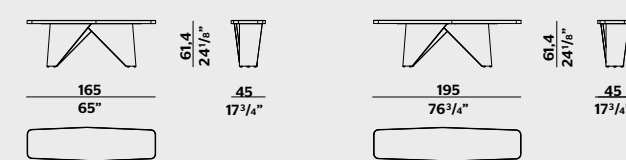

ARIA VINCENT VAN DUYSEN

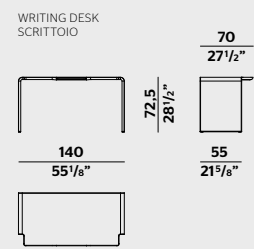

NOTE MATTEO NUNZIATI

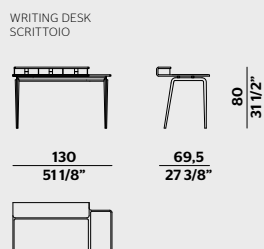

LESSLESS JEAN NOUVEL

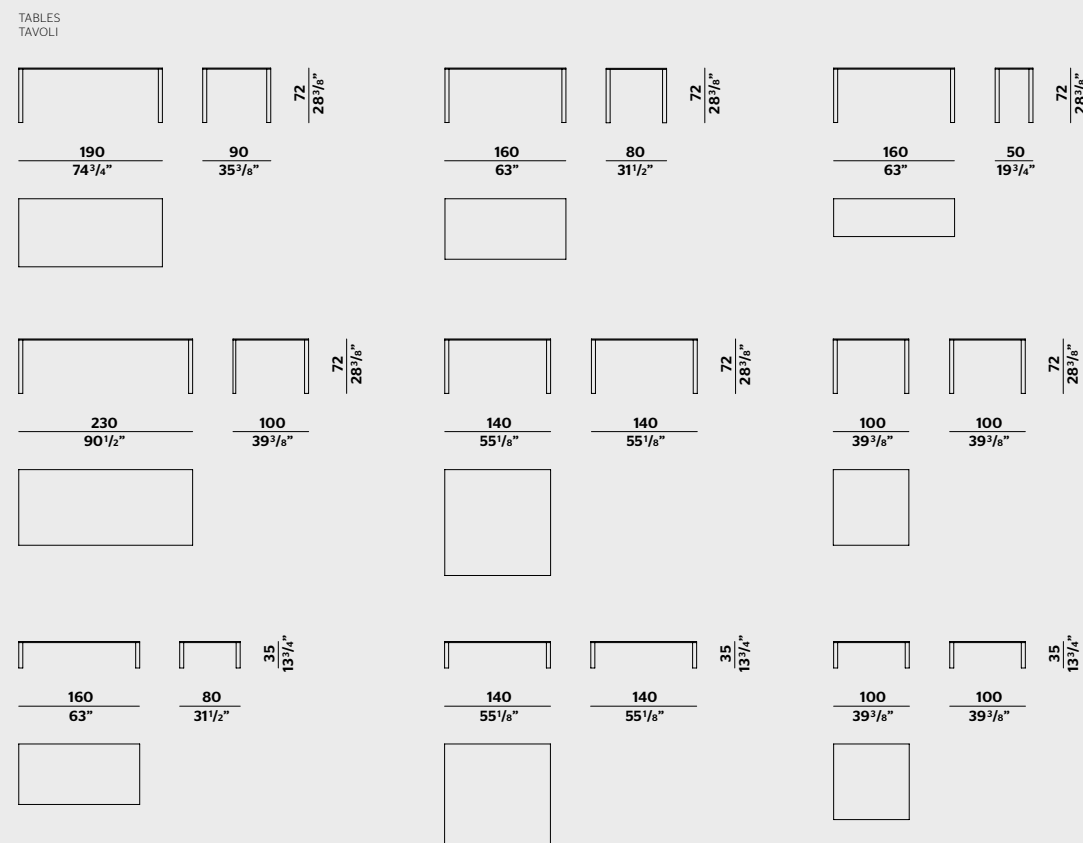

SCRIBA PATRICIA URQUIOLA

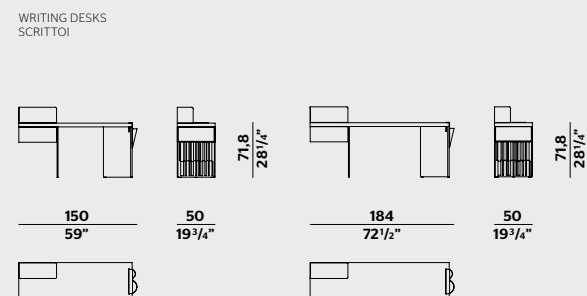

D.847.1 GIO PONTI



TOUCH DOWN UNIT STUDIO KLASS

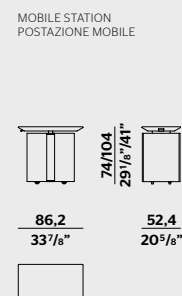

1 2 3 MICHAEL ANASTASSIADES

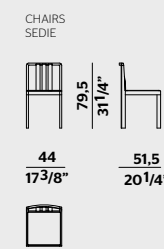

BARBICAN RODOLFO DORDONI

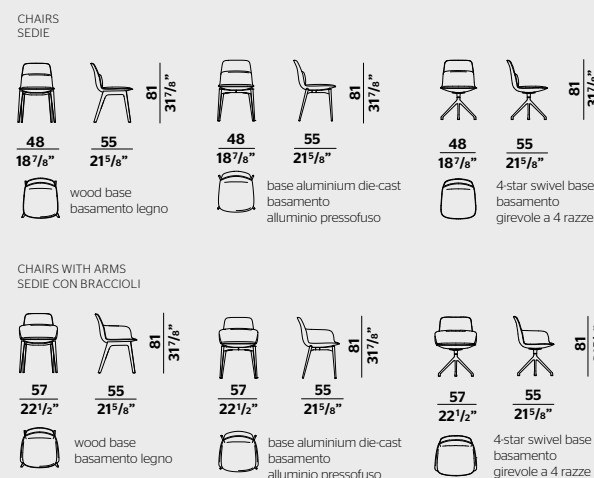

CHELSEA RODOLFO DORDONI

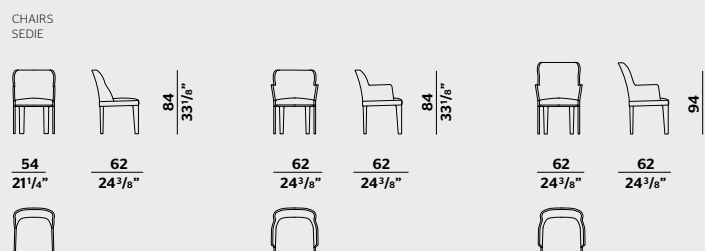

DEVON RODOLFO DORDONI

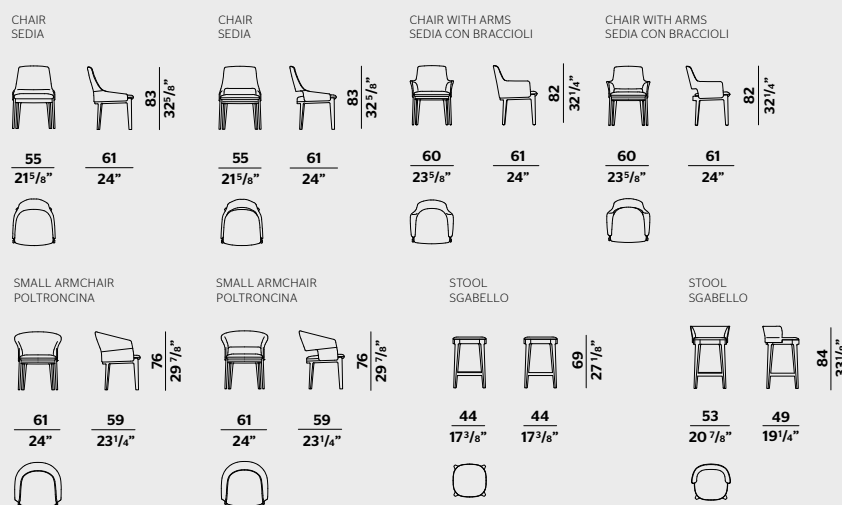

D.235.1 GIO PONTI

D.235.1 MONTECATINI CHAIR  
SEDIA D.235.1 MONTECATINI

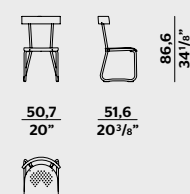

GLOVE PATRICIA URQUIOLA

CHAIR  
SEDIA

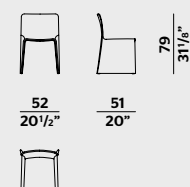

GLOVE-UP PATRICIA URQUIOLA

CHAIR  
SEDIA

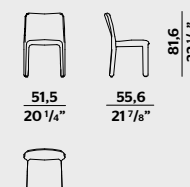

JANET VINCENT VAN DUYSSEN

CHAIR  
SEDIA

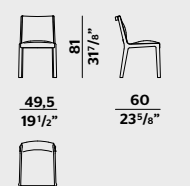

CHAIR WITH ARMS  
SEDIA CON BRACCIOLI

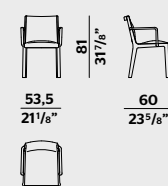

MHC.3 MISS TOBIA SCARPA

CHAIR  
SEDIA

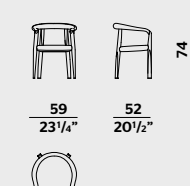

MONK TOBIA SCARPA

CHAIR  
SEDIA

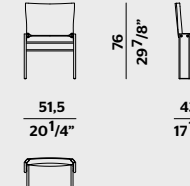

ARMCHAIR  
POLTRONA

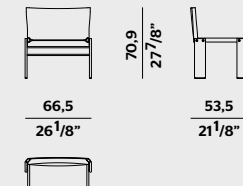

OUTLINE ARIK LEVY

CHAIRS  
SEDIE

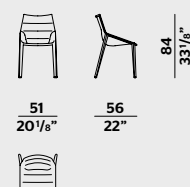

CHAIRS (VERSION WITH SEAT CUSHION)  
SEDIE (VERSIONE CON CUSCINO SEDUTA)

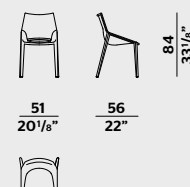

PORTA VOLTA HERZOG & DE MEURON

DINING CHAIR  
SEDIA DINING

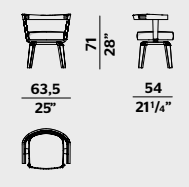

LOW CHAIR  
SEDIA LOW CHAIR

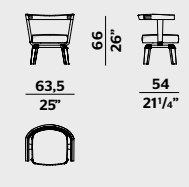

TEA JASPER MORRISON

CHAIR  
SEDIA

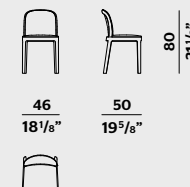

WOODY FRANCESCO MEDA

CHAIR  
SEDIA

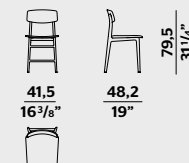

STOOL  
SGABELLO

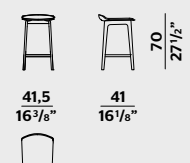

ADRIEN VINCENT VAN DUYSSEN

CUPBOARDS  
MADIE

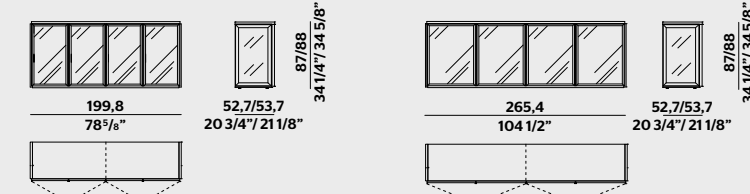

ANDROMEDA LSM

CUPBOARD  
MADIA

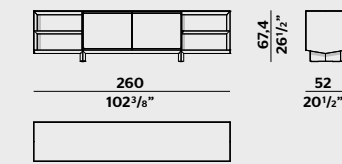

CARTEGGIO ALDO ROSSI

UNIT WITH DRAWERS  
MOBILE A CASSETTI

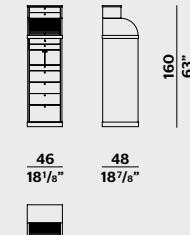

D.655.1 D.655.2 GIO PONTI

CHEST OF DRAWERS  
CASSETTONI

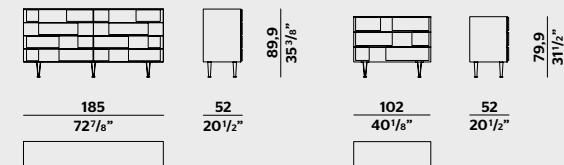

HORIZONS DANTE BONUCCELLI

CUPBOARDS  
MADIE

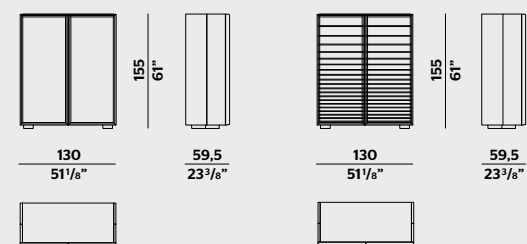

MHC.1 WERNER BLASER

CHEST OF DRAWERS  
CASSETTIERA

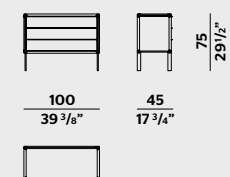

LIVING BOX VINCENT VAN DUYSSEN

BOX  
BOX

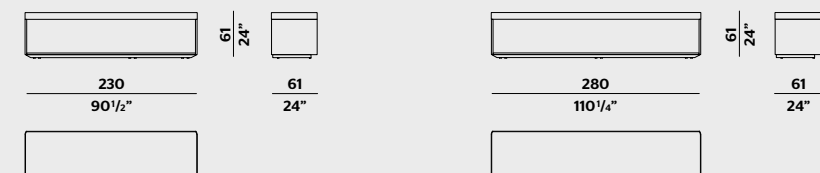

BOX  
BOX

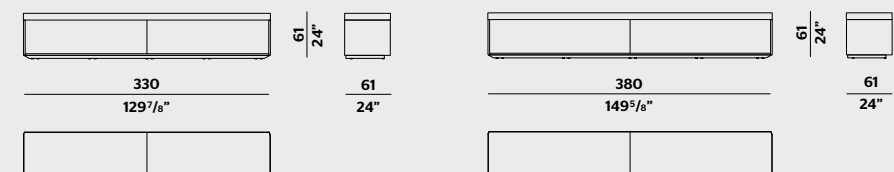

DRAWER MODULES  
MODULI CASSETTO

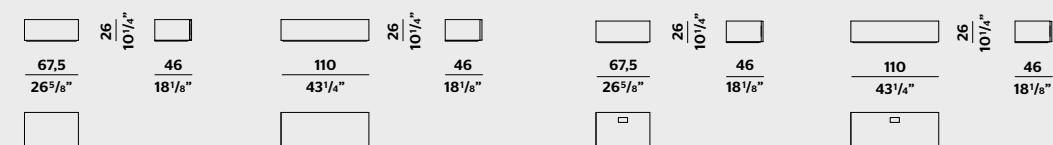

TAPE MODULES  
MODULI TAPE

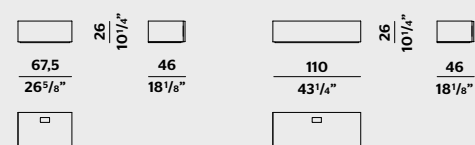

TEOREMA RON GILAD

UNITS WITH DRAWERS OR OPEN COMPARTMENT  
CONTENITORI A CASSETTO O A GIORNO

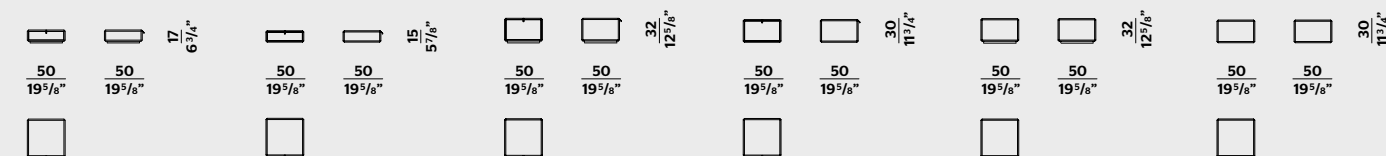

VERTICAL COMPOSITIONS H 18 1/2"  
COMPOSIZIONI VERTICALI H 47

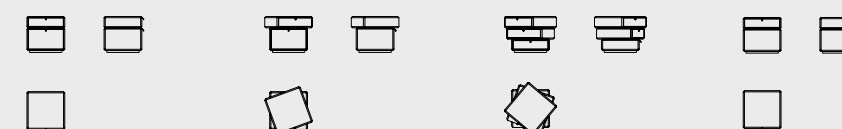

VERTICAL COMPOSITIONS H 24 3/8"  
COMPOSIZIONI VERTICALI H 62



VERTICAL COMPOSITIONS H 30 3/8"  
COMPOSIZIONI VERTICALI H 77

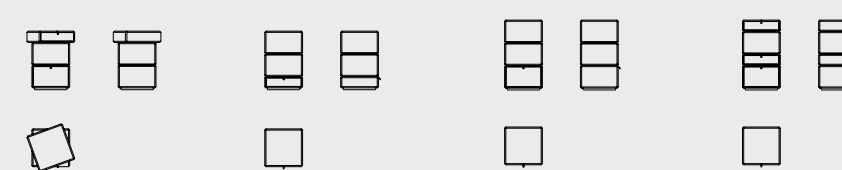

VERTICAL COMPOSITIONS H 36 1/4"  
COMPOSIZIONI VERTICALI H 92

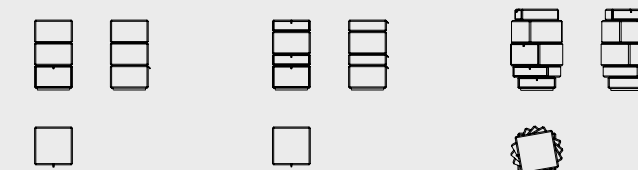

VERTICAL COMPOSITION H 42 1/8"  
COMPOSIZIONE VERTICALE H 107

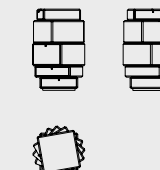

VERTICAL COMPOSITIONS H 48"  
COMPOSIZIONI VERTICALI H 122

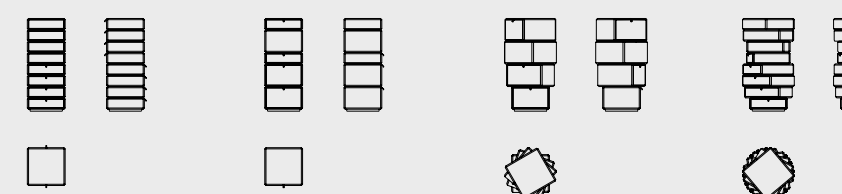

HORIZONTAL COMPOSITION H 12 5/8"  
COMPOSIZIONE ORIZZONTALE H 32

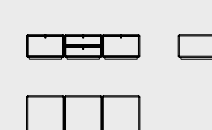

HORIZONTAL COMPOSITIONS H 24 3/8"  
COMPOSIZIONI ORIZZONTALI H 62

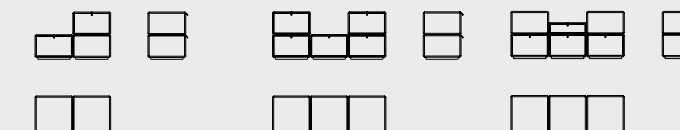

CARD MICHAEL ANASTASSIADES

BOOKCASES  
LIBRERIE

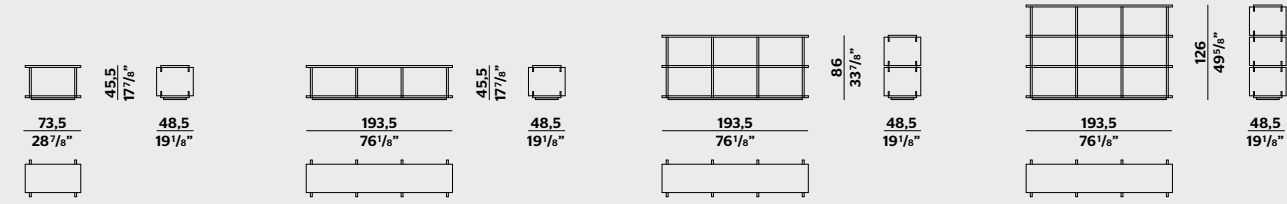

D.355.1 D.355.2 GIO PONTI

SUSPENDED BOOKCASES  
LIBRERIE SOSPESSE

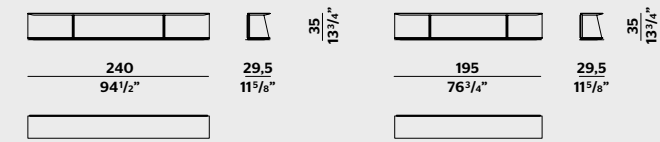

D.357.1 D.357.2 GIO PONTI

BOOKCASES  
LIBRERIE

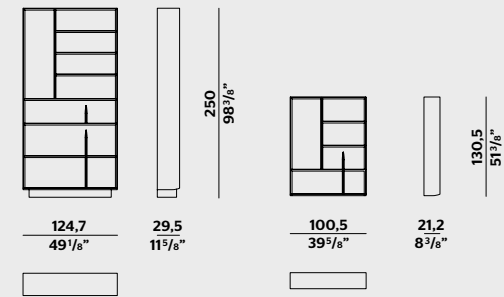

GRADUATE JEAN NOUVEL

BOOKCASES  
LIBRERIE

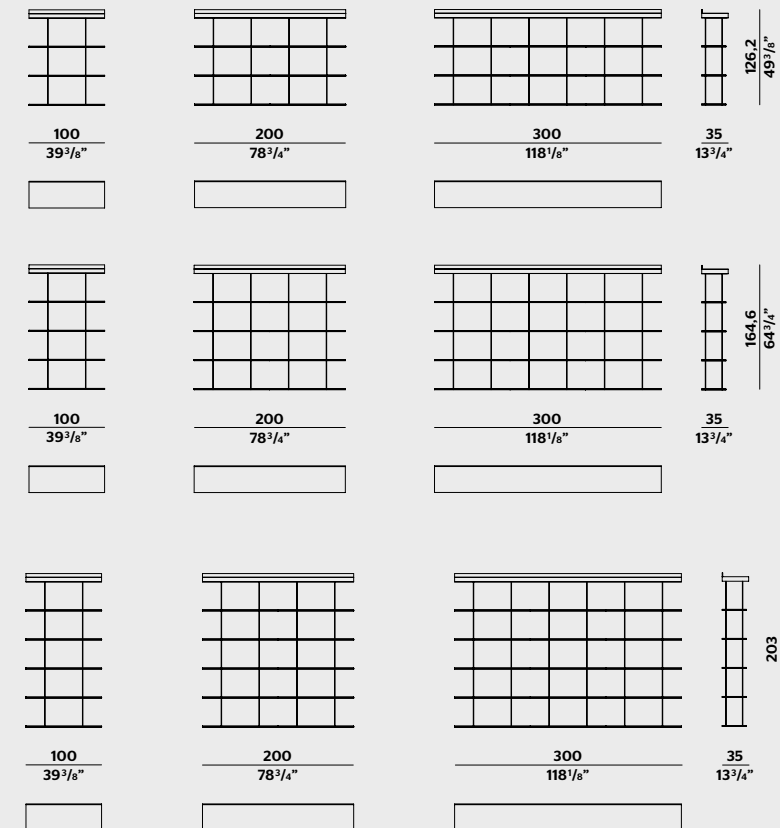

MHC.2 YASUHIKO ITOH

BOOKCASES  
LIBRERIE

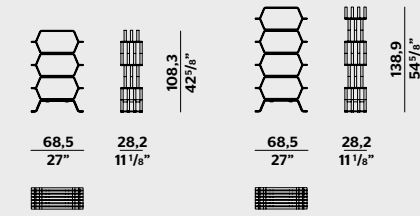

PIROSCAFO, 30TH ANNIVERSARY ALDO ROSSI, LUCA MEDA

BOOKCASES  
LIBRERIE

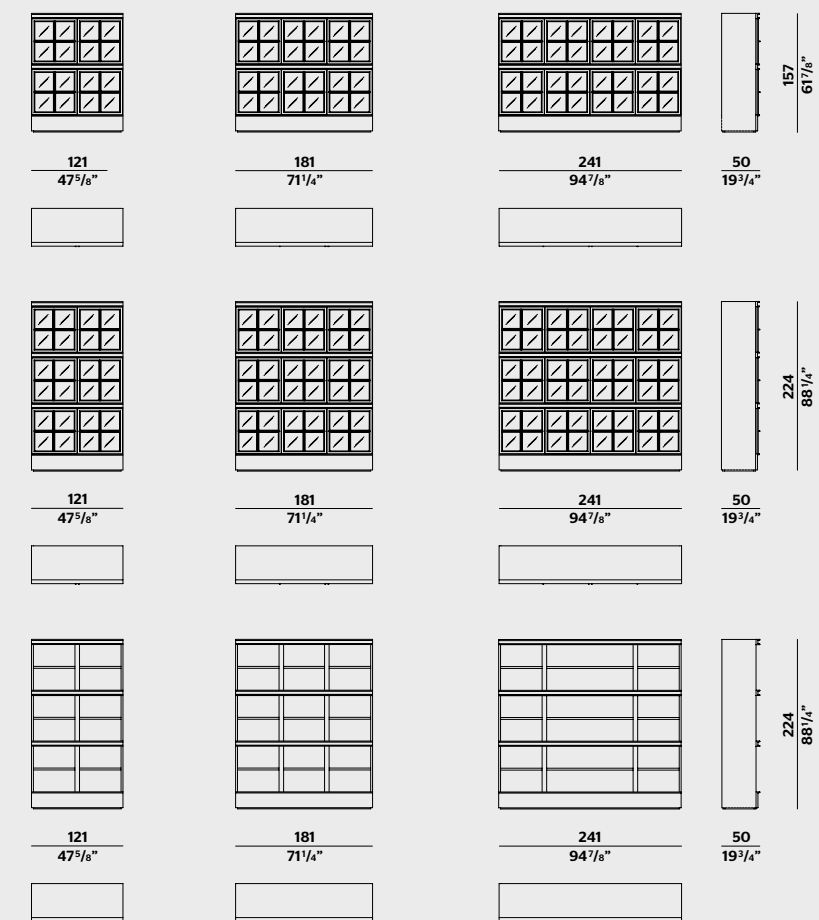

D.950.1 GIO PONTI

FRAMED MIRRORS  
CORNICI CON SPECCHIO

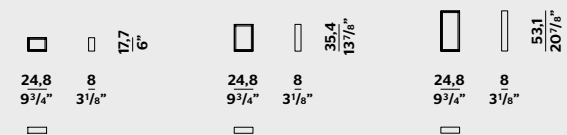

HECTOR MIRROR VINCENT VAN DUYSEN

MIRRORS  
SPECCHIERE

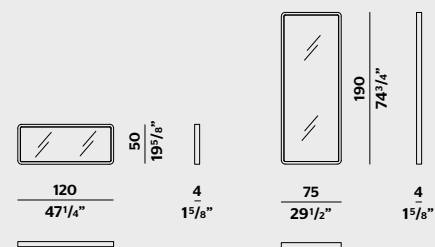

D.754.1 GIO PONTI

CARPET  
TAPPETO

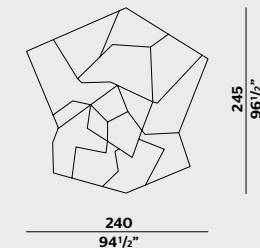

DEDALO by Pierre Frey MARTA FERRI

CARPETS  
TAPPETI

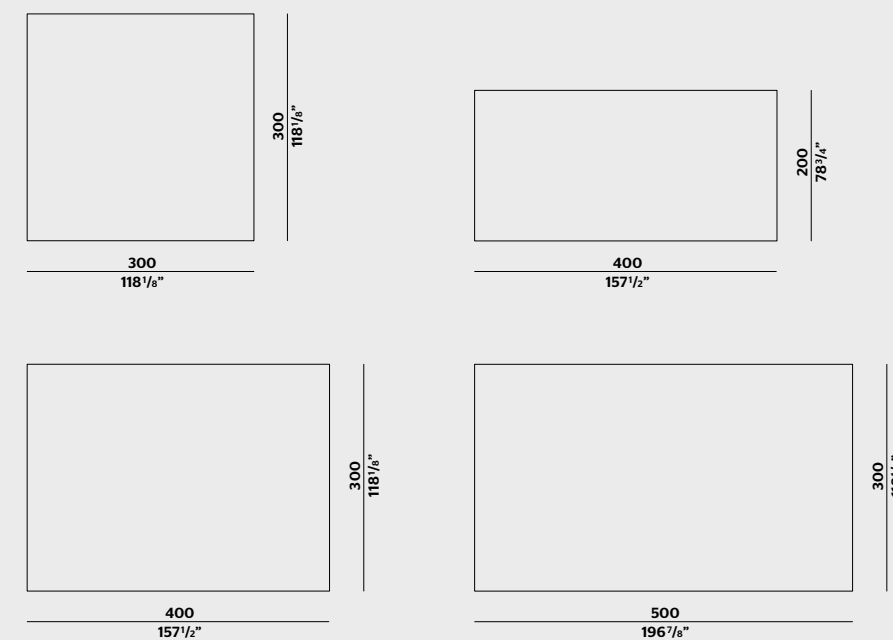

DUNA NICOLA GALLIZIA

CARPETS  
TAPPETI

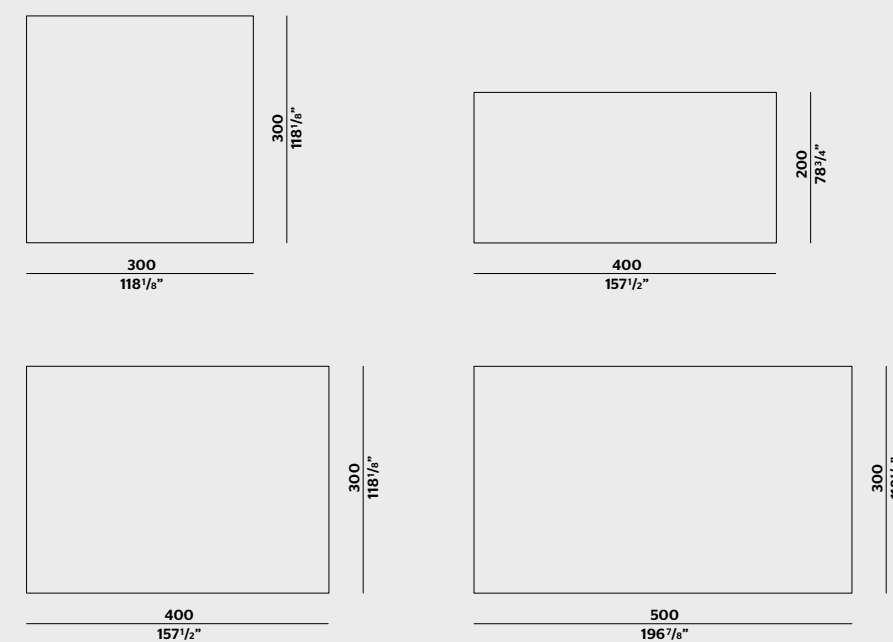

EDGE NICOLA GALLIZIA

CARPETS  
TAPPETI

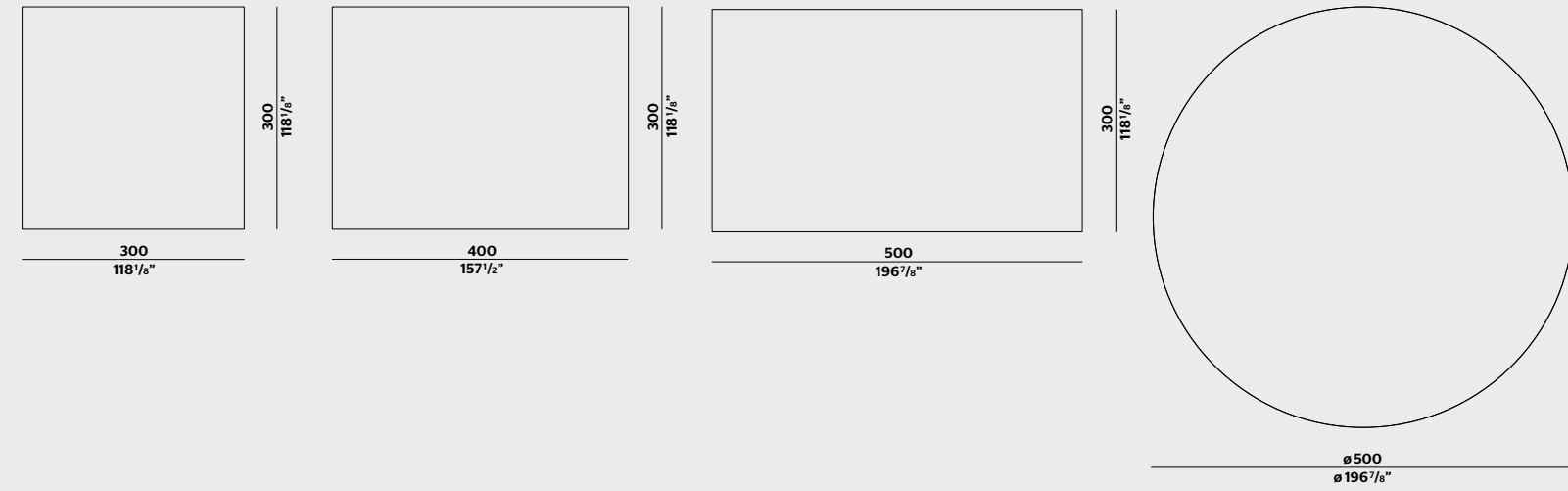

PALETTE NICOLA GALLIZIA

CARPETS  
TAPPETI

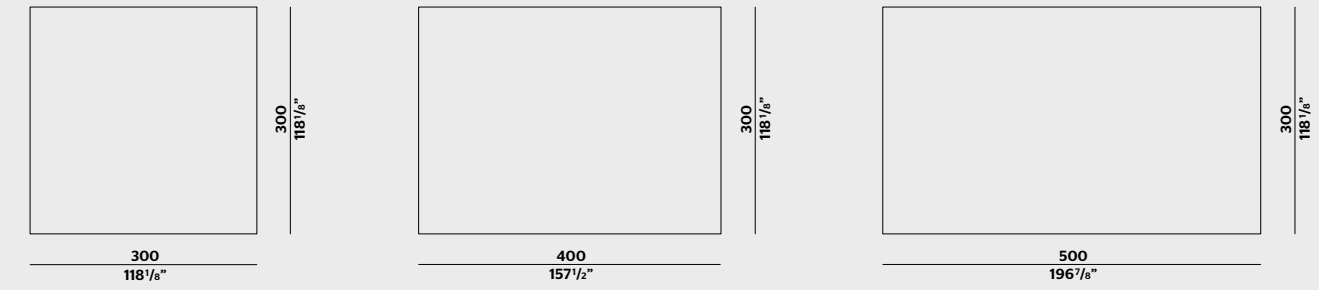

HEM by G.T.Design PATRICIA URQUIOLA

CARPETS  
TAPPETI

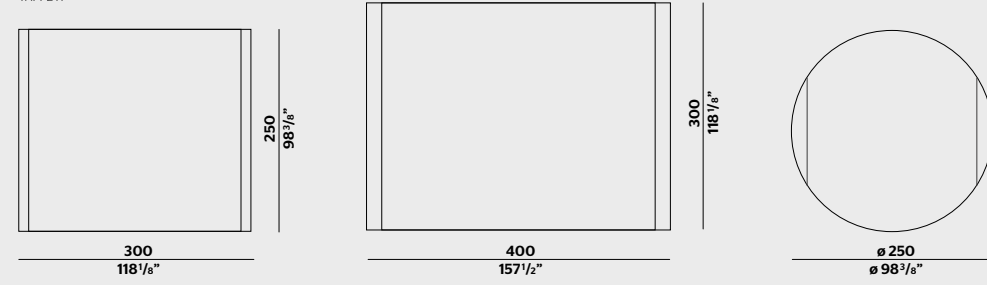

RANDOM by Altai PATRICIA URQUIOLA

CARPETS  
TAPPETI



ORIZZONTI MARTA FERRI

CARPETS  
TAPPETI

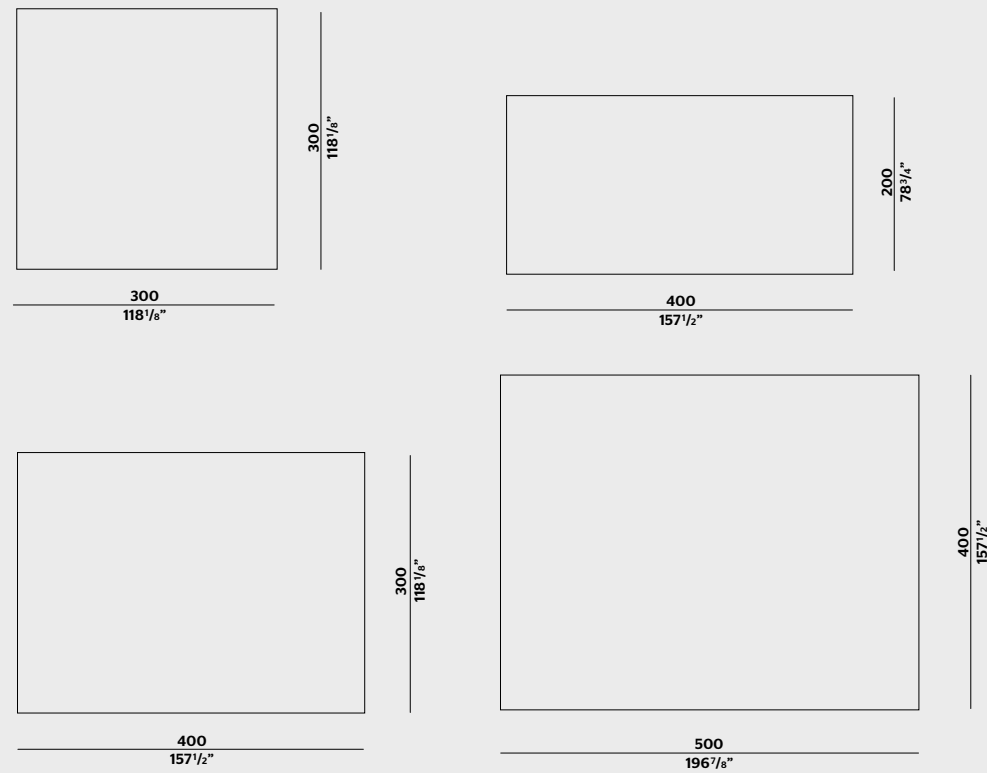

ROADS MARTA FERRI

CARPETS  
TAPPETI

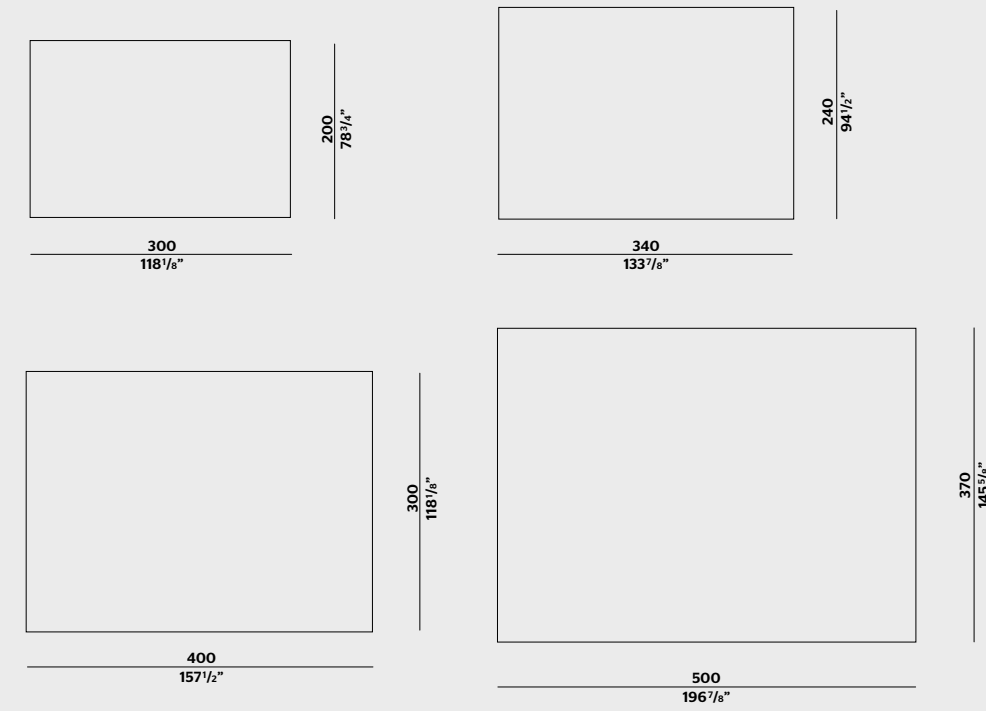

STRIPE VINCENT VAN DUYSEN

CARPETS  
TAPPETI

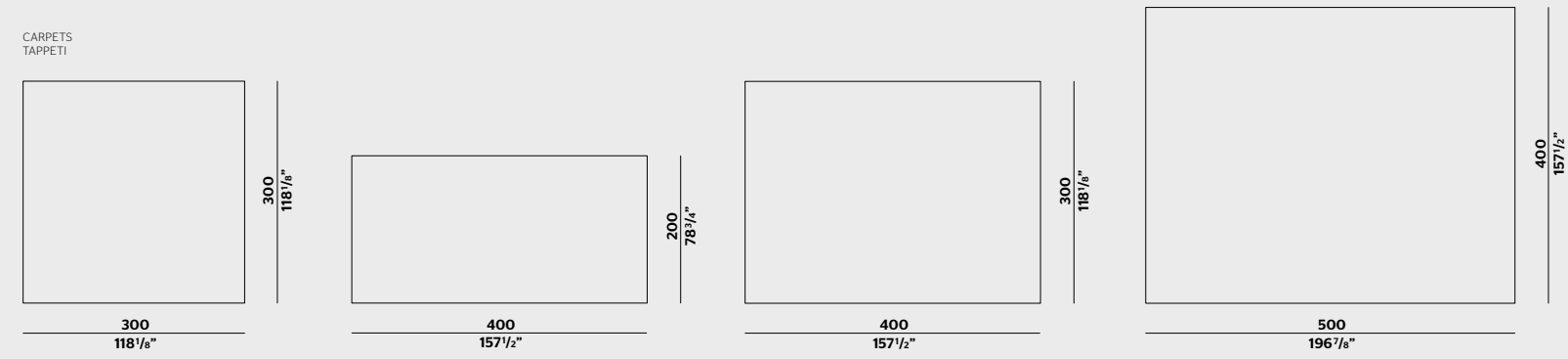

TELARO by Amini MARTA FERRI

CARPETS  
TAPPETI

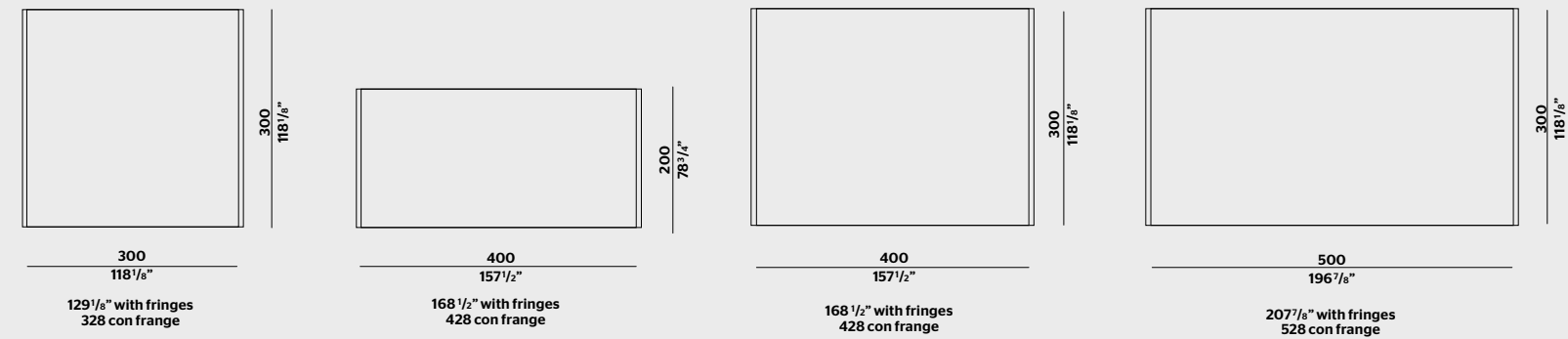

AURA NICOLA GALLIZIA

CARPETS  
TAPPETI

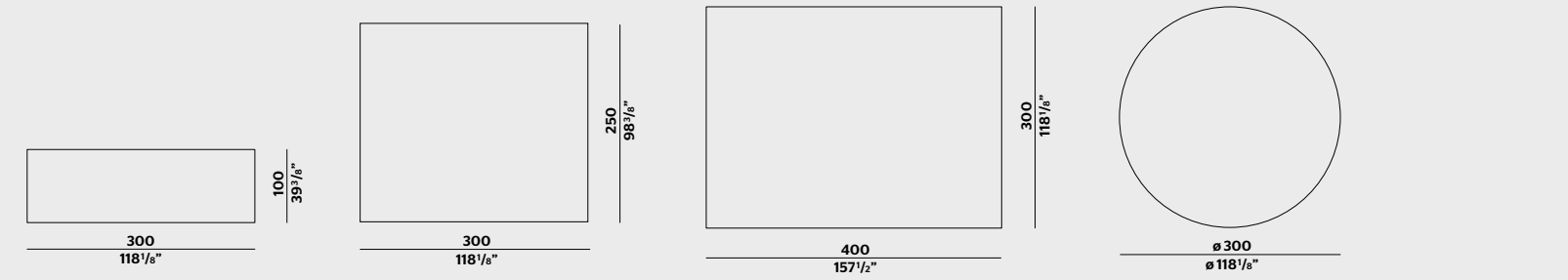

VIBRAZIONI MARTA FERRI

CARPETS  
TAPPETI

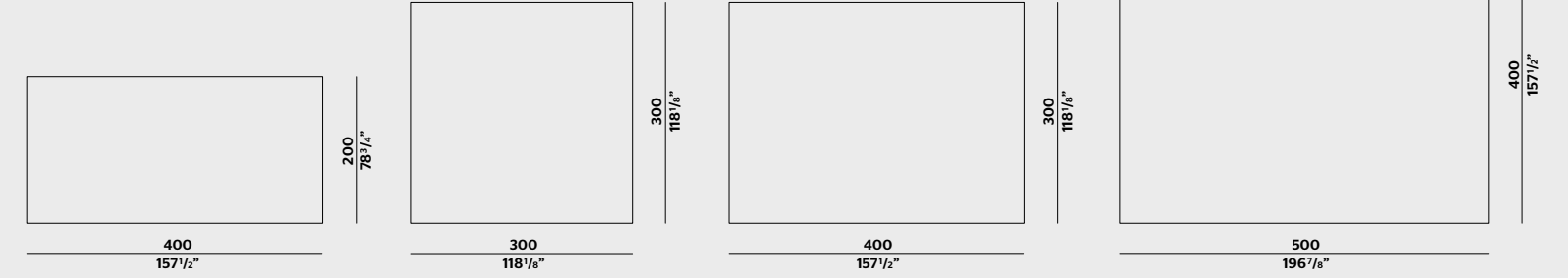

EONE NICOLA GALLIZIA

CARPETS  
TAPPETI

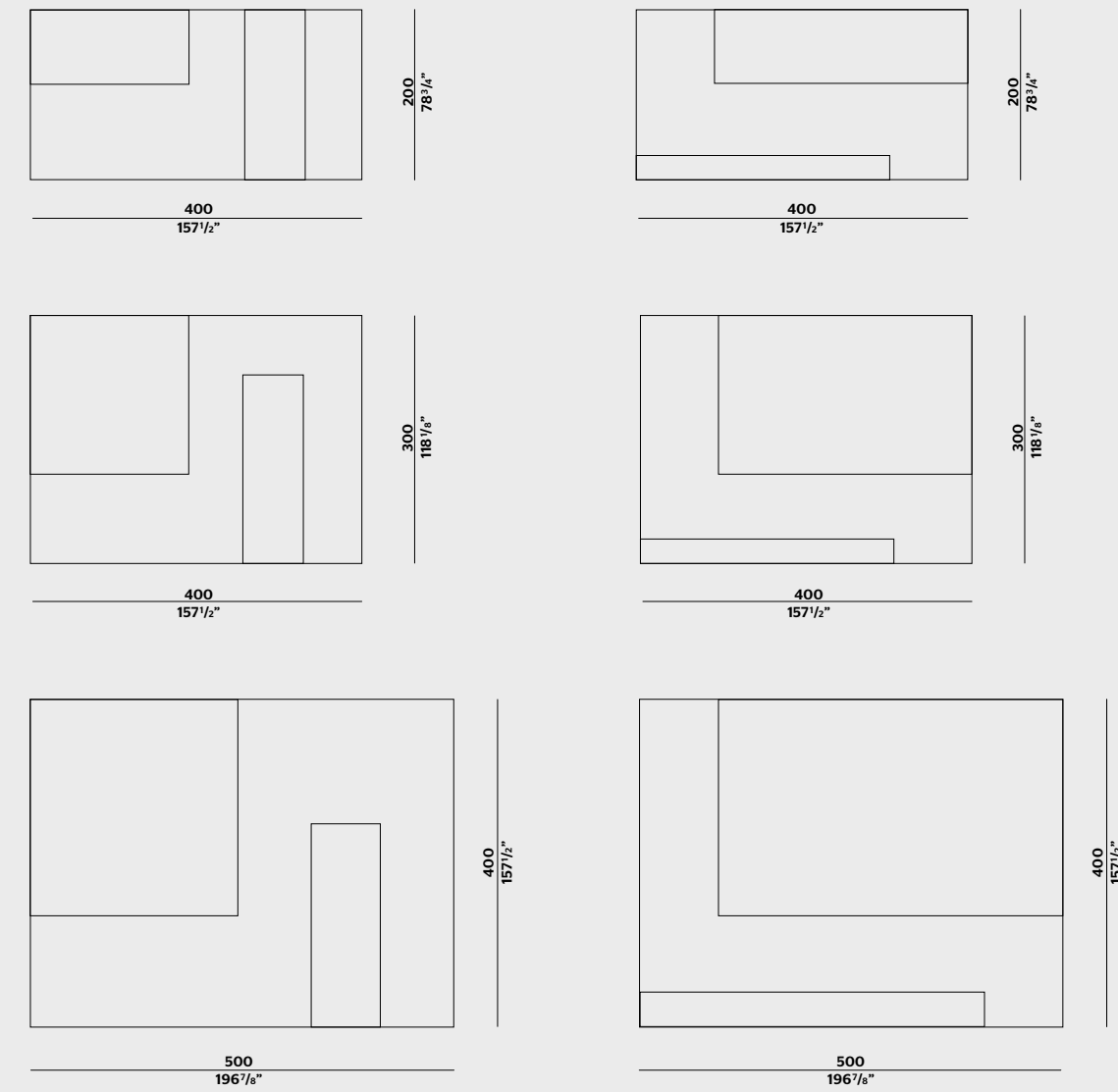

SONORO NICOLA GALLIZIA

CARPETS  
TAPPETI

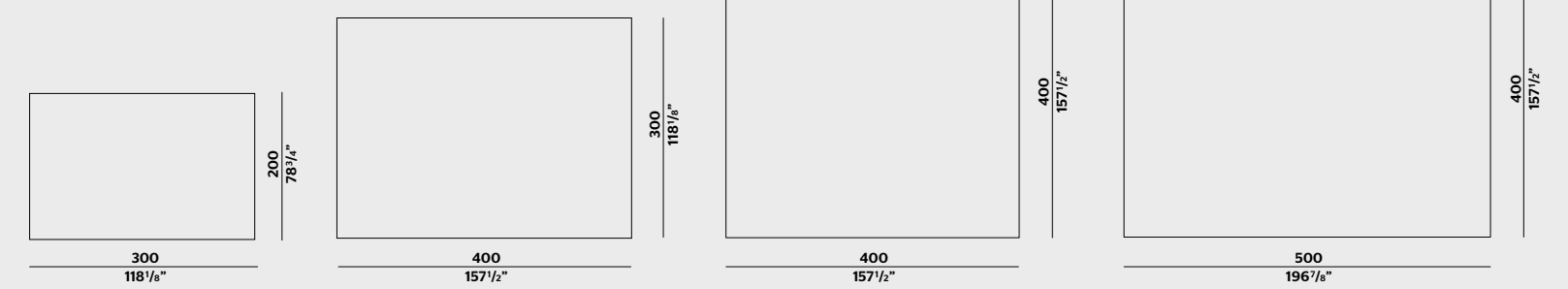



## PHOTO 2022/25 THANKS TO

ALFREDO RAPETTI MOGOL  
JOEL DENOT/ MODESTIPERDRIOLLE GALLERY  
KALPA ART LIVING GALLERIES  
MARCO SOLZI PAINTINGS  
OPERATIVA ARTE CONTEMPORANEA  
REYES VARDY ART COMPANY  
YASMIN BRANDOLINI D'ADDA

PLH  
MOTTURA  
MARAZZI

1+1 GALLERY  
ALBA GALLIZIA  
ARTEK  
ARTEMIDE  
ASTEP  
BITOSSÌ CERAMICHE  
BRUNELLO CUCINELLI  
CARLO MORETT  
CTO LIGHTING  
DANESE MILANO  
DAVIDE GROPPI  
EDITIONS MILANO  
EDIZIONI DESIGN  
ENRICO DONADELLO  
ESTILUZ  
FEDERICA BUBANI  
FILIPPO SALERNI  
GALLERIA AFRICA CURIO  
GALLERIA GIUSTINI / STAGETTI, ROMA  
GALLERIA MICHELA CATTAI  
GUAXS  
KLASSIK STUDIO  
KRISTINA DAM  
LUCEPLAN  
LUMINA  
MARTINELLI LUCE  
MICHELE REGINALDI  
NEMO LIGHTING  
NILUFAR GALLERY  
OLUCE  
ONOFRIO ACONE  
PAOLA C.  
RINA MENARDI  
RIVIERE  
SALVATORE FERRAGAMO  
SANTA&COLE  
SEASE  
UMBERTO UGHI  
VENICEM  
VITRA

## AD

VINCENT VAN DUYSSEN

## STYLING

ALESSANDRO PASINELLI STUDIO  
ANNALISA MAURI STUDIO

## PHOTO

MAX ROMMEL  
TIZIANO SARTORIO  
FILIPPO PIANTANIDA  
MAX ZAMBELLI  
ARMANDO BERTACCHI  
VITTORIO DOZIO  
ANDREA ANSALONE



MADE  
IN  
ITALY



moltenigroup.com  
moltenimuseum.com  
#MolteniGroup  
#MolteniMuseum



**PREMI COMPASSO D'ORO ADI**  
COMPASSO D'ORO ADI XVII EDIZIONE,  
1994 PREMIO ALLA CARRIERA  
2024 CAREER AWARD FOR PRODUCTS D.154.2  
DESIGN BY GIO PONTI  
**MENZIONI D'ONORE**  
**COMPASSO D'ORO ADI**  
COMPASSO D'ORO ADI XIV, EDIZIONE  
1987, LES BEAUX JOURS (LUCA MEDA)  
COMPASSO D'ORO ADI XXII, EDIZIONE  
2011, SEQUENCE (PATRICIA URQUIOLA)  
COMPASSO D'ORO ADI, EDIZIONE XXIII, 2014,  
QALLAM, (F. MOLTENI; C. COLLI; PHEFTI)  
2020 ADI COMPASSO D'ORO

**PREMI ADI INNOVAZIONE**  
PREMIO NAZIONALE INNOVAZIONE  
ADI, 2012, QALLAM  
PREMIO DEI PREMI,  
PRESIDENZA REPUBBLICA ITALIANA,  
EDIZIONE 2012 QALLAM

398 | 399

**ONLINE STORE** for US market  
Molteni&C selected pieces  
available also at [shop.molteni.it](https://shop.molteni.it)



@MolteniandC



@MolteniandC



Molteni&C



@MolteniandC



MolteniandC



Molteni&C



MolteniC



MolteniandC

■▼■ **MOLTENIGROUP.COM**



Dining